

SITE DATA:

APN: 037-221-0201030
 ZONING: R-1/5-17/DR/GH/C/D
 OCCUPANCY GROUP: R-3/U
 TYPE OF CONSTRUCTION: V-B

PLN: 2020-00070
 BLD:

APPLICABLE CODES:
 SAN MATEO COUNTY

SAN MATEO COUNTY ZONING & BUILDING ORDINANCES
 2022 CALIFORNIA RESIDENTIAL CODE
 2022 CALIFORNIA BUILDING CODE
 2022 CALIFORNIA MECHANICAL CODE
 2022 CALIFORNIA PLUMBING CODE
 2022 CALIFORNIA ELECTRICAL CODE
 2022 CALIFORNIA ENERGY CODE
 2022 CALIFORNIA FIRE CODE
 2022 CALIFORNIA GREEN BUILDING STANDARDS CODE

OWNER: Randolph & Maria MUKAEDA
 105 Rosa Flora Circ.
 South San Francisco, CA 94080

ARCHITECT: Edward C. Love, Architect
 720 Mill St
 Half Moon Bay, CA 94019

GEOTECHNICAL ENGINEERING: Sigma Prime Geosciences
 322 Princeton Ave.
 Half Moon Bay, 94019
 650.728.3590

STRUCTURAL ENGINEERING: XYZ Engineering
 Address 1
 Address 2
 650.xxx.xxxx

	EXISTING		PROPOSED		TOTAL		ALLOWED	
	AREA (SQFT)	%	AREA (SQFT)	%	AREA (SQFT)	%	AREA (SQFT)	%
LOT AREA	5643							
LOT COVERAGE	0	0.0	1844	32.7	1844	32.7	1975	35.0
FLOOR AREA			FIRST FLR: SECOND FLR: GARAGE: 586 1385 1015		FIRST FLR: SECOND FLR: GARAGE: 586 1385 1015			
Total	0	0.0	Total 2986	52.9	Total 2986	52.9	Total 2991	53.0

SCOPE OF WORK:

CONSTRUCTION OF A 2986 SQFT SINGLE FAMILY RESIDENCE
 W/ ATTACHED GARAGE

Sheet List - Const.

Sheet No.	Sheet Name	Rev
A001	Cover Sheet	
A002	Additional Notes	
SU1	Survey	
A003	Site Plan	
C1	Grading & Drainage	
C2	Erosion & Sediment Control	
C3	Best Management Practices	
A101	First Floor Plan	
A102	Second Floor Plan	
A103	Roof Plan	
A104	Door & Window Schedule	
A201	Elevations - West & South	
A202	Elevations - East & North	
A301	Section Views	
A501	Details	
A502	Details	
A503	Color Board	
E101	First Floor Electrical Plan	
E102	First Floor Lighting Plan	
E103	Second Floor Electrical Plan	
E104	Second Floor Lighting Plan	
L1	Conceptual Landscape	

REVISIONS

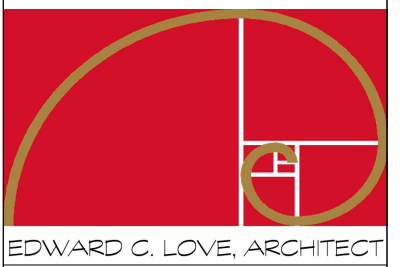

Edward C. Love
 Architect
 720 MILL STREET
 HALF MOON BAY, CA 94019
 (650) 728-7615
 edwardclovearch@gmail.com

New Residence for
 the Mukaeda family
 Cypress Ave
 Moss Beach, CA

Cover Sheet

FOR
 REVIEW
 ONLY

DATE: 4/30/2024

SCALE:

DRAWN: GMH

JOB: MUKAEDA

SHEET:

A001

OF SHEETS

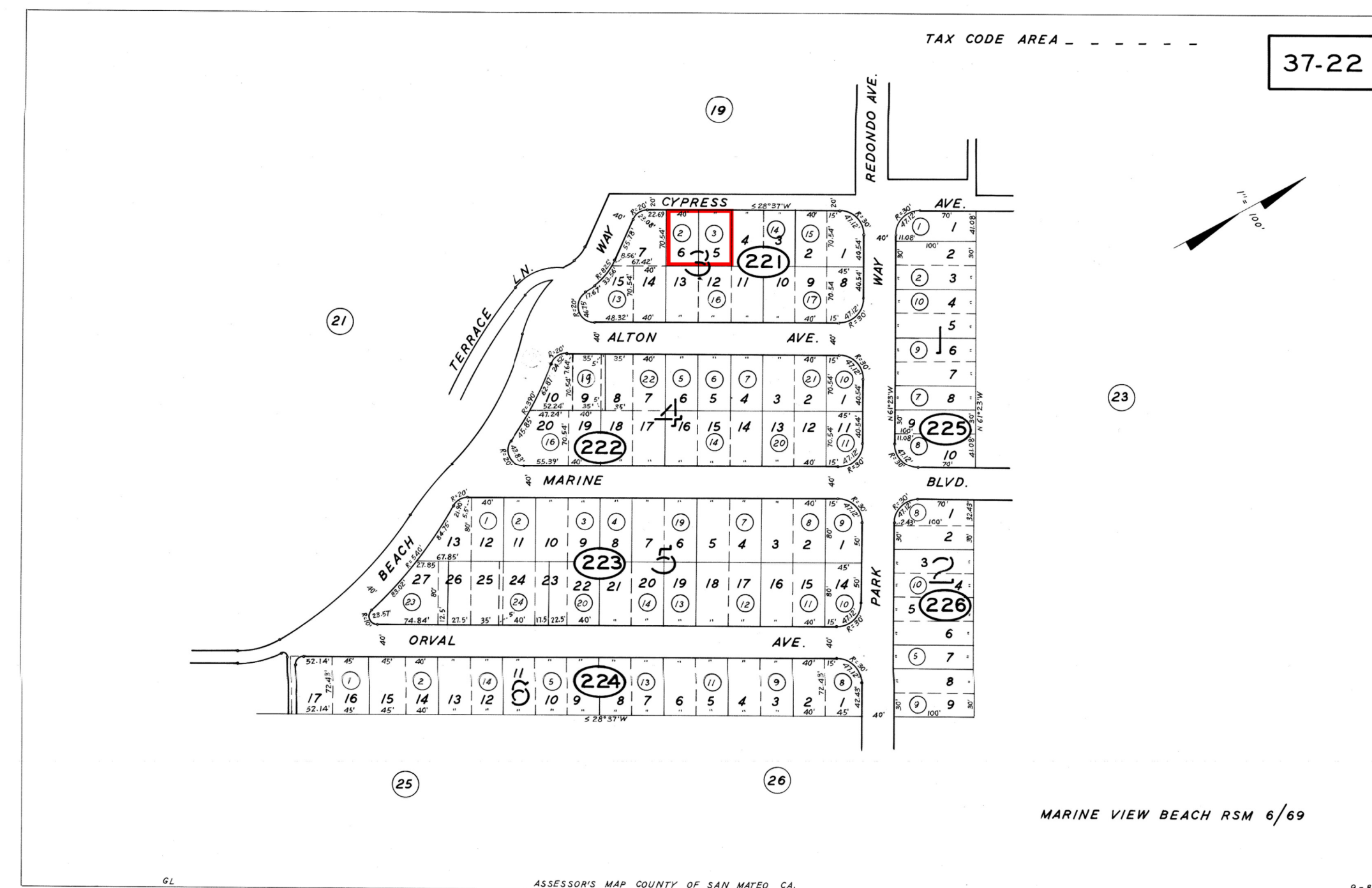

GENERAL NOTES

- BEFORE SUBMITTING A PROPOSAL FOR THIS WORK, THE BIDDER SHALL VISIT THE SITE AND LEARN THE EXISTING CONDITIONS. HE SHALL EXAMINE THE PLANS AND SPECIFICATIONS AND BASE HIS BID ON THEM. DURING CONSTRUCTION, NO CHANGES FROM PLANS AND SPECIFICATIONS SHALL BE MADE WITHOUT WRITTEN CONSENT OF THE ARCHITECT AND OWNER. STRUCTURAL CHANGES MUST BE APPROVED BY THE ARCHITECT AND STRUCTURAL ENGINEER.
- THE GENERAL CONTRACTOR (G.C.) SHALL OBTAIN AND PAY FOR ALL PERMITS (EXCEPT THOSE PAID FOR BY THE OWNER) AND LICENSES AND SHALL GIVE ALL NOTICES. THE G.C. IS REQUIRED TO COMPLY WITH ALL CURRENT CODES, ORDINANCES, & REGULATIONS RELATED TO THIS PROJECT. ANY CONFLICT BETWEEN DRAWINGS, SPECIFICATIONS AND ORDINANCES SHALL BE IMMEDIATELY REFERRED TO THE ARCHITECT IN WRITING. THE G.C. FOR THIS WORK SHALL BE CURRENTLY LICENSED BY THE STATE OF CALIFORNIA. THE EMPLOYEES AND SUBCONTRACTORS USED BY THE G.C. TO CONSTRUCT AND FINISH THE WORK SHOWN ON THE PLANS MUST ALL BE SKILLED WORKMEN UNDER THE DIRECTIONS OF A COMPETENT FOREMAN. THE G.C. SHALL CONTINUOUSLY MAINTAIN ADEQUATE PROTECTION OF ALL WORK FROM DAMAGE AND SHALL PROTECT THE OWNER'S PROPERTY AND ADJACENT PROPERTY FROM INJURY, DAMAGE, OR LOSS ARISING FROM THIS CONTRACT. SALES TAX SHALL BE PAID BY THE G.C. AND INCLUDED IN THE BID.
- THE G.C. SHALL, AT ALL TIMES, KEEP THE PREMISES AND STREETS FREE OF WASTE AND RUBBISH CAUSED BY THE WORK, AND AT COMPLETION, SHALL REMOVE ALL RUBBISH, SURPLUS MATERIALS AND EQUIPMENT AND LEAVE THE WORK 'BROOM CLEAN'. THE G.C. SHALL VERIFY THE LOCATION OF ALL EXISTING UNDERGROUND UTILITIES PRIOR TO EXCAVATION AND SHALL MAINTAIN, KEEP IN SERVICE, AND PROTECT AGAINST DAMAGE, ALL EXISTING UTILITIES AND CITY SERVICES DURING CONSTRUCTION. ANY EXISTING UTILITIES TO BE ABANDONED SHALL BE PROPERLY DISCONNECTED, PLUGGED, OR CAPPED AS REQUIRED BY CODE AND/OR SOUND CONSTRUCTION PRACTICES. G.C. TO PROVIDE AN OPERATION AND MAINTENANCE MANUAL WILL BE PROVIDED TO OCCUPANT OR OWNER PER SECTION 4.410.1.
- THE OWNER MAY ORDER EXTRA WORK OR MAKE CHANGES BY ALTERING, ADDING TO, OR DEDUCTING FROM THE WORK. THE CONTRACT SUM SHALL BE ADJUSTED ACCORDINGLY AND ADEQUATE RECORDS SHALL BE KEPT BY THE G.C. TO SUBSTANTIATE ANY ADDITIONAL CHARGES. ALL SUCH WORK SHALL BE EXECUTED UNDER THE CONDITIONS OF THE ORIGINAL CONTRACT DOCUMENTS.
- THE OWNER SHALL NOT BE LIABLE OR RESPONSIBLE FOR ANY ACCIDENT, LOSS, INJURY, OR DAMAGES HAPPENING OR ACCRUING DURING THE TERM OF THE PERFORMANCE OF THE WORK AND IN CONNECTION THEREWITH, TO PERSONS AND/OR PROPERTY. THE G.C. SHALL HAVE IN FULL FORCE AND EFFECT DURING THE LIFE OF THIS CONTRACT, FULL COVERAGE LIABILITY AND WORKMEN'S COMPENSATION INSURANCE, WHICH SHALL COMPLY WITH CALIFORNIA LAWS AND WILL NOT BE CANCELED OR CHANGED DURING THE TERM OF THIS CONTRACT WITHOUT NOTICE BEING GIVEN TO THE OWNER, AND SHALL REQUIRE ALL INTERMEDIATE AND SUBCONTRACTORS TO TAKE OUT AND MAINTAIN SIMILAR POLICIES OF INSURANCE. ALL SUCH POLICIES SHALL BE WITH INSURANCE COMPANIES ACCEPTABLE TO THE OWNER. UNLESS EXPRESSLY STATED OTHERWISE, THE OWNER WILL TAKE OUT AND CARRY A COMPREHENSIVE INSURANCE POLICY INCLUDING FIRE, EXTENDED COVERAGE, VANDALISM AND MALICIOUS MISCHIEF PROTECTING BOTH HIS INTEREST AND THAT OF THE G.C.
- IN ADDITION TO GUARANTEES CALLED FOR ELSEWHERE IN THESE SPECIFICATIONS, THE G.C. SHALL GUARANTEE ALL WORK FOR A PERIOD OF ONE (1) YEAR AFTER NOTICE OF COMPLETION IS FILED, AGAINST DEFECTIVE MATERIALS OR FAULTY WORKMANSHIP, THAT IS DISCOVERED AND REPORTED WITHIN THAT PERIOD.
- IN GENERAL THE DRAWINGS WILL INDICATE DIMENSIONS, POSITION, TYPE OF CONSTRUCTION, SPECIFICATIONS, QUALITIES AND METHODS. ANY WORK INDICATED ON THE DRAWINGS, AND NOT MENTIONED IN THE SPECIFICATIONS, OR VICE VERSA, SHALL BE FURNISHED AS THOUGH FULLY SET FORTH IN BOTH. WORK NOT PARTICULARLY DETAILED, MARKED, OR SPECIFIED SHALL BE THE SAME AS SIMILAR PARTS THAT ARE DETAILED, MARKED OR SPECIFIED. THE LARGER THE SCALE OF THE DRAWING, THE MORE PRECEDENT, I.E.: 3 INCHES PER FOOT SCALE GOVERNS 1/4 INCH PER FOOT SCALE. WRITTEN DIMENSIONS ON THESE DRAWINGS SHALL HAVE PRECEDENCE OVER SCALED DIMENSIONS. WRITTEN DIMENSIONS ARE APPROXIMATE AND MUST BE VERIFIED BY G.C. THE G.C. SHALL VERIFY, AND BE RESPONSIBLE FOR ALL EXISTING CONDITIONS AND DIMENSIONS PRIOR TO, AND DURING, ALL PHASES OF WORK.
- IF ANY SUBCONTRACTOR FINDS ANY LACK OF INFORMATION, DISCREPANCY, AND/OR OMISSIONS IN THESE DRAWINGS, OR IF THE SUBCONTRACTOR IS UNCLEAR AS TO THE DRAWINGS' MEANING AND/OR INTENT, THE SUBCONTRACTOR SHALL CONTACT THE G.C., WHO SHALL THEN CONTACT THE ARCHITECT AT ONCE FOR INTERPRETATION AND/OR CLARIFICATION BEFORE PROCEEDING WITH THAT PORTION OF THE WORK.
- THE G.C. SHALL PROVIDE ADEQUATE CONCEALED BLOCKING AND ANCHORING FOR ALL CEILING- AND WALL-MOUNTED EQUIPMENT, HARDWARE, FIXTURES, AND ACCESSORIES.
- ALL PRODUCTS LISTED IN THESE DRAWINGS BY NER NUMBER SHALL BE INSTALLED PER THE REPORT AND MANUFACTURER'S WRITTEN INSTRUCTIONS. PRODUCT SUBSTITUTION FOR PRODUCTS LISTED SHALL ALSO HAVE AN NER-APPROVED WRITTEN EVALUATION REPORT AND BE APPROVED AND LISTED BY OTHER NATIONALLY-RECOGNIZED TESTING AGENCIES.
- EXTERIOR OPENABLE WINDOWS AND DOORS SHALL BE WEATHERSTRIPPED. ALL OPEN JOINTS, PENETRATIONS, AND OTHER OPENINGS IN THE BUILDING ENVELOPE SHALL BE SEALED, CAULKED, GASKETED, AND/OR WEATHERSTRIPPED TO LIMIT, OR ELIMINATE, AIR LEAKAGE.
- SEE STRUCTURAL SHEETS FOR STRUCTURAL MATERIALS, DIMENSIONS AND DETAILS.
- SEE ATTACHED TITLE 24 FORMS AND/OR CALCULATION FOR PROJECT ENERGY EFFICIENCY REQUIREMENTS.
- A CAPILLARY BREAK SHALL BE INSTALLED IF A SLAB ON GRADE FOUNDATION SYSTEM IS USED. THE USE OF A 4" THICK BAS OF 1/2" OR LARGER CLEAN AGGREGATE UNDER A 6 MIL VAPOR RETARDER WITH JOINT LAPPED NOT LESS THAN 6" WILL BE PROVIDED PER SECTION 4.505.2 AND R506.2.3.
- UPON REQUEST, VERIFICATION OF COMPLIANCE WITH THE RELEVANT CODES MAY INCLUDE CONSTRUCTION DOCUMENTS, PLANS, SPECIFICATIONS, BUILDER OR INSTALLER CERTIFICATION, INSPECTION REPORTS, OR OTHER METHODS ACCEPTABLE TO THE BUILDING OFFICIAL WHICH SHOW SUBSTANTIAL CONFORMANCE.

- CONSTRUCTION WASTE MANAGEMENT PLAN SHALL BE SUBMITTED PER CALGREEN 4.408.2 (OR IN ACCORDANCE WITH LOCAL ORDINANCE). MINIMUM OF 65% OF CONSTRUCTION WASTE SHALL BE DIVERTED FOR RECYCLING OR SALVAGE PER CALGREEN 4.408.1
- OPERATIONS & MAINTENANCE MANUALS SHALL BE PROVIDED TO BUILDING OWNER ADDRESSING ITEMS 1 - 10 IN CALGREEN 4.410.1
- DUCT SYSTEMS SHALL BE SIZED, DESIGNED, AND EQUIPED PER CALGREEN 4.507.2. HVAC SYSTEM INSTALLERS MUST BE TRAINED AND CERTIFIED AND SPECIAL INSPECTORS EMPLOYED BY THE ENFORCING AGENCY MUST BE QUALIFIED.
- BATHROOM EXHAUST FANS SHALL COMPLY WITH CALGREEN 4.506.1. EACH BATHROOM SHALL BE MECHANICALLY VENTILATED WITH AN ENERGY STAR EXHAUST FAN AND MUST BE CONTROLLED BY A HUMIDITY SENSOR.
- PROTECT ANNULAR SPACES AROUND PIPES, ELECTRICAL CABLES, CONDUITS OR OTHER OPENINGS AT EXTERIOR WALLS AGAINST THE PASSAGE OF RODENTS (CALGREEN 4.406.1)
- COVER DUCT OPENINGS AND OTHER RELATED AIR DISTRIBUTION COMPONENT OPENINGS DURING CONSTRUCTION (CALGREEN 4.504.1)
- ADHESIVES, SEALANTS, AND CAULKS SHALL BE COMPLIANT WITH VOC AND OTHER TOXIC COMPOUND LIMITS (CALGREEN 4.504.2.1)
- PAINTS, STAINS, AND OTHER COATINGS SHALL BE COMPLIANT WITH VOC LIMITS (CALGREEN 4.504.2.2)
- AEROSOL PAINTS AND COATINGS SHALL BE COMPLIANT WITH PRODUCT WEIGHTED MIR LIMITS FOR ROC AND TOXIC COMPOUNDS (CALGREEN 4.504.2.3). VERIFICATION OF COMPLIANCE SHALL BE PROVIDED.
- CARPET AND CARPET SYSTEMS SHALL BE COMPLIANT WITH VOC LIMITS (CALGREEN 4.504.3)
- MINIMUM OF 80" FLOOR AREA RECEIVING RESILIENT FLOORING SHALL COMPLY WITH CALGREEN 4.504.4
- PARTICLEBOARD, MEDIUM DENSITY FIBERBOARD (MDF), AND HARDWOOD PLYWOOD USED IN INTERIOR FINISH SYSTEMS SHALL COMPLY WITH LOW FORMALDEHYDE EMISSION STANDARDS (CALGREEN 4.504.5)
- INSTALL CAPILLARY BREAK AND VAPOR RETARDER AT SLAB ON GRADE FOUNDATIONS (CALLGREEN 4.505.2)
- CHECK MOISTURE CONTENT OF BUILDING MATERIALS USED IN WALL AND FLOOR FRAMING BEFORE ENCLOSURE (CALGREEN 4.505.3)

HERS INSPECTION ITEMS

The following is a summary of the features that must be field-verified by a certified HERS Rater as a condition for meeting the modeled energy performance for this computer analysis. Additional detail is provided in the building components tables below.

- Building-level Verifications:
- High quality insulation installation (QII)
 - IAQ mechanical ventilation

- Cooling System Verifications:
- None --

- HVAC Distribution System Verifications:
- Duct Sealing

- Domestic Hot Water System Verifications:
- None --

Smoke Detectors

As per the California Building Code, State Fire Marshal regulations, and Coastside Fire District Ordinance 2022-01, the applicant is required to install State Fire Marshal approved and listed smoke detectors which are hard wired, interconnected, and have battery backup. These detectors are required to be placed in each new and reconditioned sleeping room and at a point centrally located in the corridor or area giving access to each separate sleeping area. In existing sleeping rooms, areas may have battery powered smoke alarms. A minimum of one detector shall be placed on each floor. Smoke detectors shall be tested and approved prior to the building final. Date of installation must be added to exterior of the smoke alarm and will be checked at final.

Smoke alarm/detector are to be hard wired, interconnected, or with battery back up. Smoke alarms to be installed per manufacturers instruction and NFPA 72.

Windows

Escape or rescue windows shall have a minimum net clear openable area of 5.7 square ft (sqft), 5.0 sqft allowed at grade. The minimum net clear openable height dimension shall be 24 inches. The net clear openable width dimension shall be 20 inches. Finished sill height shall not be more than 44 inches above the finished floor (CFC 1030).

Address Markers

New residential buildings shall have internally illuminated address numbers contrasting with the background so as to be seen from the public way fronting the building. The letters/numerals for permanent address signs shall be 6 inches in height with a minimum of 1/2 inch stroke. Residential address numbers shall be at least six feet above the finished surface of the driveway. Where buildings are located remotely to the public roadway, an additional signage at the driveway/roadway entrance leading to the building and/or on each individual building shall be required by the Coastside Fire District. This remote signage shall consist of a 6 inch by 18 inch green reflective metal sign with 3 inch reflective numbers/letters similar to Hy-Ko 911 or equivalent. (TEMPORARY ADDRESS NUMBERS SHALL BE POSTED PRIOR TO COMBUSTIBLES BEING PLACED ON SITE).

Roofing

As per Coastside Fire District Ordinance 2019-03, the roof covering of every new building or structure, and materials applied as part of a roof covering assembly, shall have a minimum fire rating of Class "B" or higher as defined in the current addition of the California Building Code.

Vegetation Management (LBA)

The Coastside Fire District Ordinance 2022-01, the 2022 California Fire Code 304.1.2:

A fuel break of defensible space shall be required around the perimeter of all structures to a distance of not less than 30 feet and may be required to a distance of 100 feet or to the property line. this is neither a requirement nor an authorization for the removal of living trees.

Trees located within the defensible space shall be pruned to remove dead and dying portions, and limbed up 6 feet above the ground. New trees planted in the defensible space shall be located no closer than 10 feet to adjacent trees when fully grown or at maturity.

Remove that portion of any existing trees, which extends within 10 feet of the outlet of a chimney or stovepipe or is within 5 feet of any structure. Maintain any tree adjacent to or overhanging a building free of dead or dying wood.

Fire Access Roads

The applicant must have a maintained asphalt surface road for ingress and egress of fire apparatus. The city of Half Moon Bay Department of Public Works, San Mateo County Department of Public Works, the Coastside Fire District Ordinance 2022-01, and the California Fire Code shall set road standards. As per the 2022 CFC, Dead-end roads exceeding 150 feet shall be provided with a turnaround in accordance with Coastside Fire District specifications. As per the 2022 CFC, Section Appendix D, road width shall not be less than 20 feet. Fire access roads shall be installed and made serviceable prior to combustibles being placed of the project site and maintained during construction. Approved signs and painted curbs or lines shall be provided and maintained to identify fire access roads and state the prohibition of their obstruction. If the road width does not allow parking on the street (20 foot road) and on-street parking is desired, an additional improved area shall be developed for that use.

Fire Hydrant

As per 2022 CFC, Appendix B and C, a fire district approved fire hydrant (Clow 960) must be located within 500 feet of the proposed single-family dwelling unit measured by way of drivable access. As per 2022 CFC, Appendix B the hydrant must produce a minimum fire flow of 500 gallons per minute at 20 pounds per square inch residual pressure for 2 hours. Contact the local water purveyor for water flow details.

Automatic Fire Sprinkler System (Fire Sprinkler plans will require a separate permit)

As per San Mateo County Building Standards and Coastside Fire District Ordinance 2022-03, the applicant is required to install an automatic fire sprinkler system throughout the proposed or improved dwelling and garage. All attic access locations will be provided with a pilot head on metal upright. Sprinkler coverage shall be provided throughout the residence to include all bathrooms, garages, and any area used for storage. The only exception is small linen closets less than 24 square feet with full depth shelving. The plans for this system must be submitted to the San Mateo County Planning and Building Division or the City of HMB. A building permit will not be issued until plans are received, reviewed, and approved. Upon submission of plans, the County or City will forward a complete set to the Coastside Fire District for review.

Installation of underground sprinkler pipe shall be flushed and visually inspected by Fire District prior to hook-up to riser. Any soldered fittings must be pressure tested with trench open. Please call Coastside Fire District to schedule an inspection. Fees shall be paid prior to plan review.

An exterior bell and interior horn/strobe are required to be wired into the required flow switch on your fire sprinkler system. The bell, horn/strobe, and flow switch, along with the garage door opener, are to be wired into a separate circuit breaker at the main electrical panel and labeled.

Solar Photovoltaic Systems

These systems shall meet the requirements of the 2022 CFC Section 605.11.

REVISIONS



EDWARD C. LOVE, ARCHITECT

Edward C. Love
Architect
720 MILL STREET
HALF MOON BAY, CA 94019
(650) 728-7615
edwardclovearch@gmail.com

New Residence for
the Mukaeda family
Cypress Ave
Moss Beach, CA

Additional Notes

FOR REVIEW ONLY

DATE: 4/30/2024

SCALE:

DRAWN: GMH

JOB: MUKAEDA

SHEET:

A002

OF SHEETS

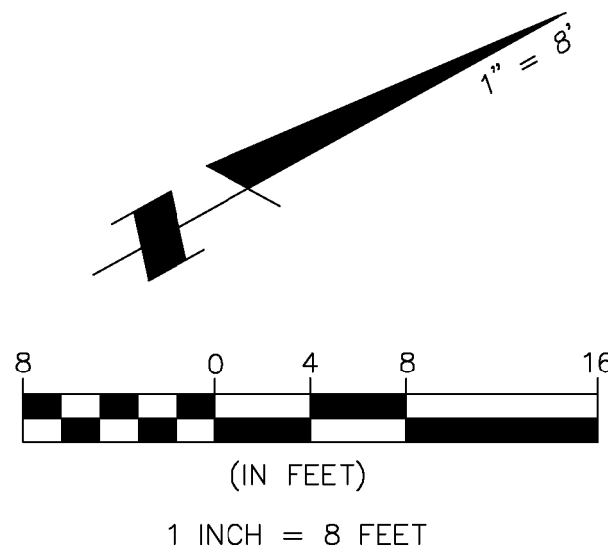

BASIS OF BEARINGS

THE BEARING, NORTH 61°23' WEST, OF PARK WAY, AS SHOWN ON THAT CERTAIN SUBDIVISION MAP ENTITLED, "MARINE VIEW BEACH" WHICH WAS FILED FOR RECORD IN BOOK 6 MAPS PAGE 69, SAN MATEO COUNTY RECORDS, WAS USED AS THE BASIS OF BEARINGS FOR THIS SURVEY.

BENCHMARK

ELEVATIONS SHOWN HEREON ARE BASED UPON THE NATIONAL GEODETIC VERTICAL DATUM 1929 (NGVD29). BASIS OF VERTICAL DATUM HELD: 941 4129 TIDAL 5 (PID: HT0455) NGVD29 PUBLISHED ELEVATION: 11.45 FEET.

LOCAL BENCHMARK TO USE FOR SITE WORK IS THE SPIKE AND STAINLESS STEEL WASHER WITH AN ELEVATION OF 66.52 FEET.

NOTES:

BGT DID NOT RECEIVE A TITLE REPORT COVERING THE SUBJECT PROPERTY; THEREFORE, ANY EASEMENTS OF RECORD AFFECTING IT COULD NOT BE PLOTTED HEREON.

UTILITIES SHOWN HEREON TAKEN FROM VISUAL SURFACE EVIDENCE AND SHOULD BE CONSIDERED AS APPROXIMATE ONLY. ACTUAL LOCATIONS OF UTILITIES MAY VARY. TRUE LOCATION OF UTILITIES CAN ONLY BE OBTAINED BY EXPOSING THE UTILITY.

SURVEY PERFORMED BY: BGT LAND SURVEYING
www.bgtsurveying.com

DATE OF FIELD SURVEY: AUGUST, 2016
JOB NUMBER: 16-081

LEGEND

AC ASPHALT CONCRETE	MON-MON MONUMENT TO MONUMENT DISTANCE
BW BACK OF WALK	PBVL PACBELL/SBC VAULT
CB CATCH BASIN	PG&E VAULT
C/L CENTERLINE	PIV POST INDICATOR VALVE
CMP CORRUGATED METAL PIPE	PP POWER POLE
C CAST IRON PIPE	PPM STORM DRAIN MANHOLE
CO CLEAN OUT BOX	SL STREET LIGHT
CP SURVEY CONTROL POINT	SLB STREET LIGHT BOX
CPP CORRUGATED PLASTIC PIPE	SLV STREET LIGHT VAULT
CTV CABLE TELEVISION LINE	SSMH SANITARY SEWER MANHOLE
DI DROP INLET	SSV SANITARY SEWER VAULT
EM ELECTRIC METER	TBC TOP BACK OF CURB
EV ELECTRIC VAULT	TBM TEMPORARY BENCHMARK
FF FINISHED FLOOR	TS TRAFFIC SIGNAL
FL FLOWLINE	TSB TRAFFIC SIGNAL BOX
FI FIRE HYDRANT	UNK UNKNOWN TYPE
GM GAS METER	VCP VITRIFIED CLAY PIPE
GR GROUND	WBF WATER BACK FLOW VALVE
GUY GUY ANCHOR	WM WATER METER BOX
GV GAS VALVE	WV WATER VALVE
HVE HANDICAP RAMP	-CIV- CABLE TELEVISION LINE
HVE HIGH-VOLT ELECTRIC	-E- ELECTRICAL LINE
INV. INVERT	-G- GAS LINE
IP IRON PIPE	-OH- OVERHEAD LINE
JP JOINT POLE	-SD- STORM DRAIN LINE
KV KILOVOLT	-SS- SANITARY SEWER LINE
LAT. LATERAL	-T- TELEPHONE LINE
LG LIP OF GUTTER	-W- WATER LINE
LH LAMP HOLE	
MH (TYPE UNKNOWN)	

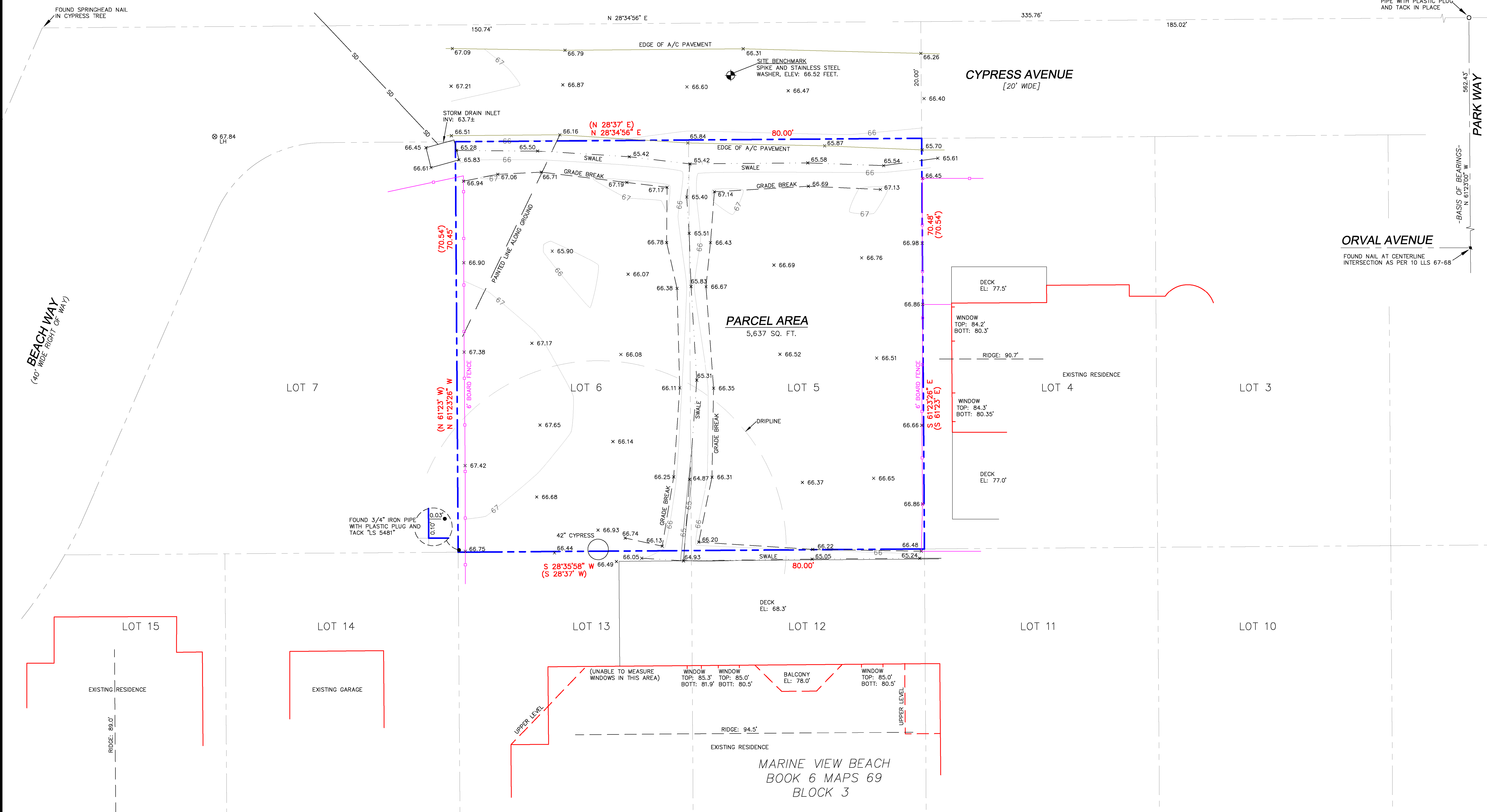

BOUNDARY AND TOPOGRAPHIC SURVEY
 LOTS 5-6, BLOCK 3, "MARINE VIEW BEACH" (BOOK 6 MAPS 69)
VACANT, CYPRESS AVENUE
 MOSS BEACH, SAN MATEO COUNTY, CALIFORNIA

Assessor Parcel Number:
037-221-020
037-221-030

Prepared For:
RANDOLPH MUKAEDA
105 Rosa Flora Circle
So. San Francisco, CA 94080

Date: AUGUST, 2016
Scale: 1" = 8'
Contour Interval: 1'
Drawn by: BGT
Revisions:

SU-1

Job No. 16-081

S:\Client Projects 2017\Mukaeda\Revit\Mukaeda-V03.rvt

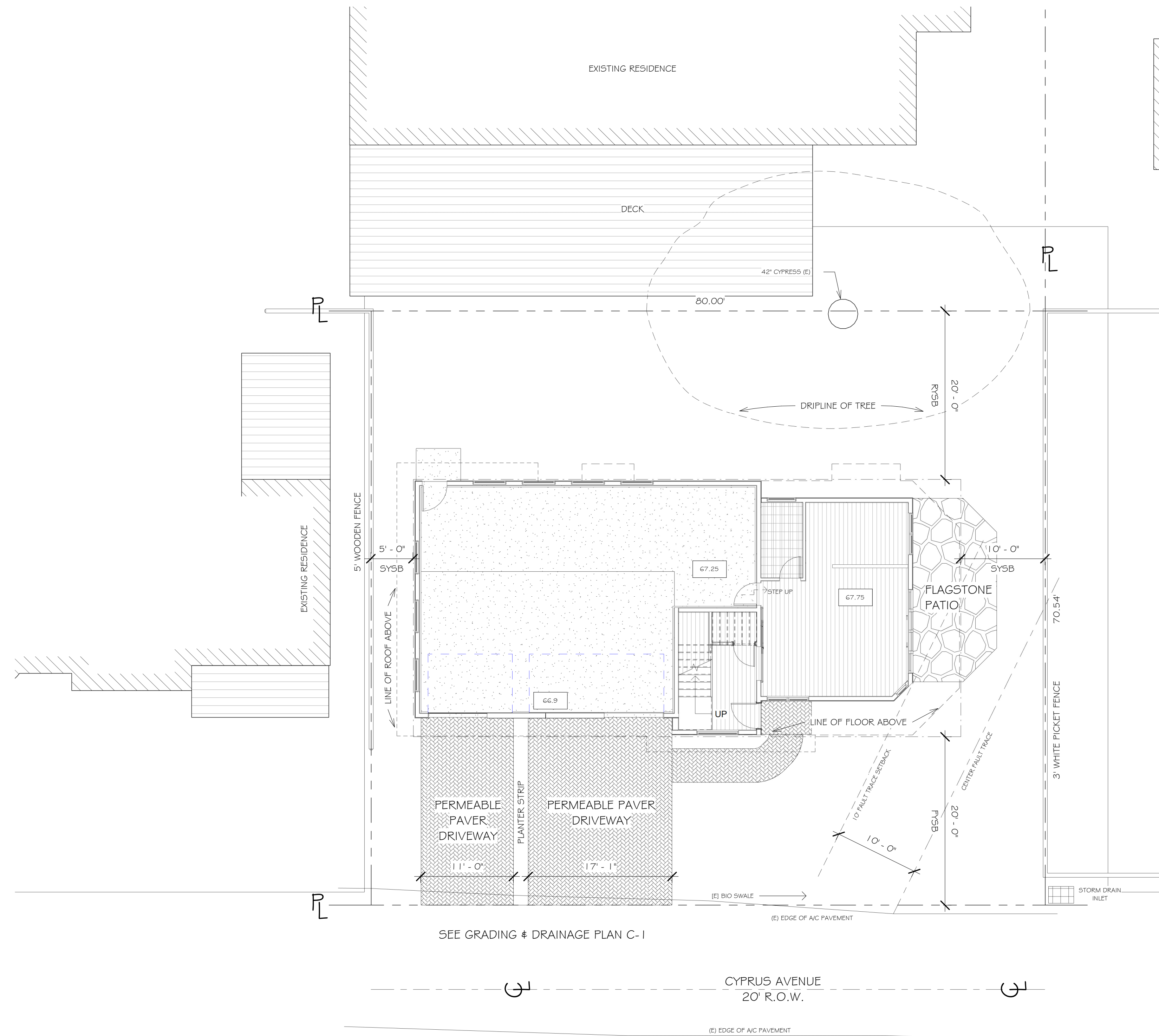

1 Site Plan
1/8" = 1'-0"

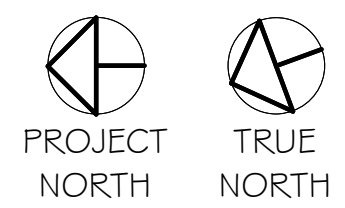

REVISIONS

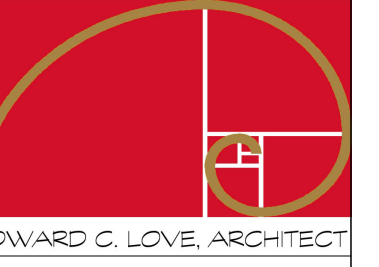

Edward C. Love
Architect
720 MILL STREET
HALF MOON BAY, CA 94019
(650) 728-7615
edwardclovearch@gmail.com

New Residence for
the Mukaeda family
Cypress Ave
Moss Beach, CA

Site Plan

FOR
REVIEW
ONLY

DATE: 4/30/2024

SCALE: 1/8" = 1'-0"

DRAWN: GMH

JOB: MUKAEDA

SHEET:

A003

OF SHEETS

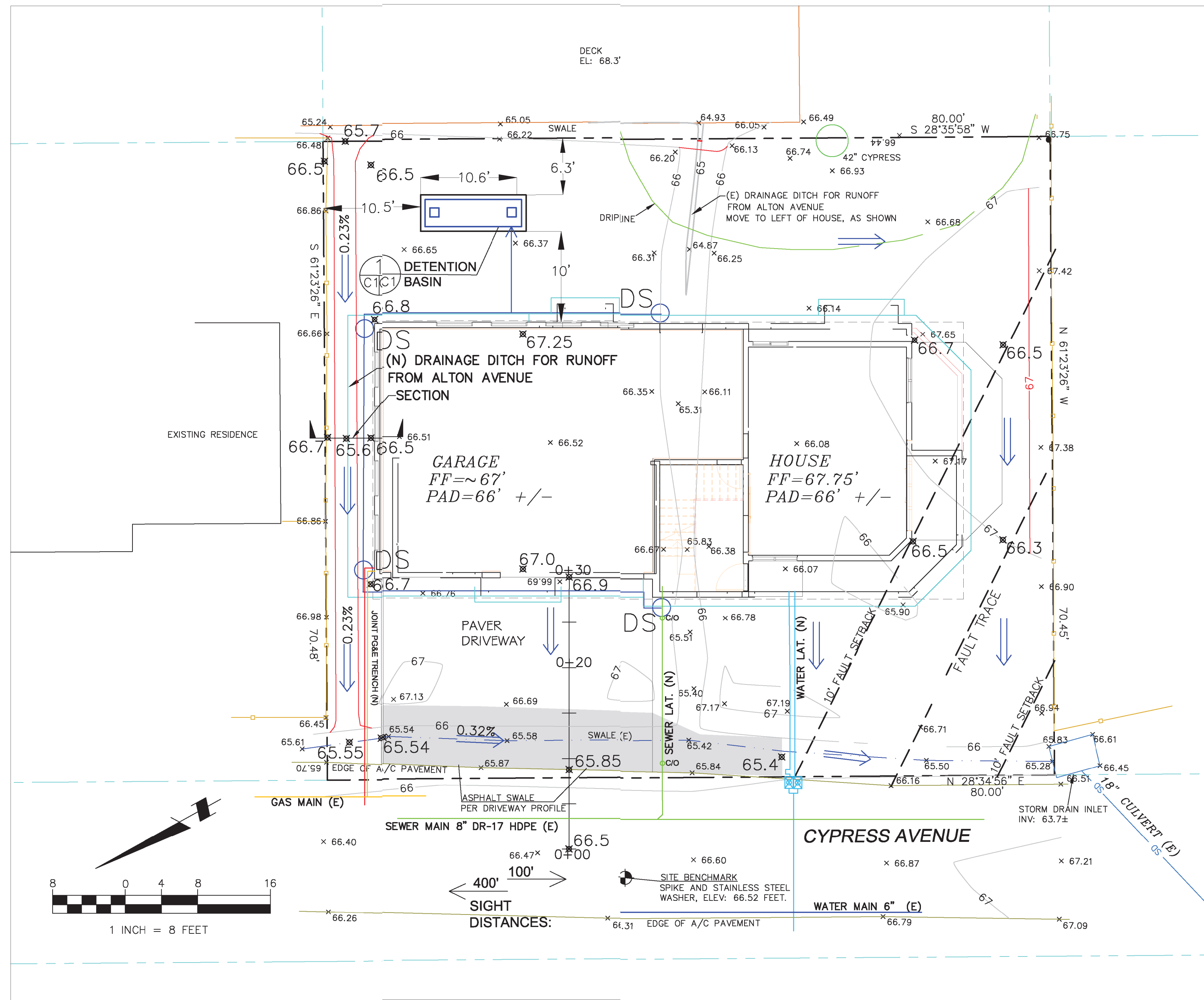

- LEGEND**
- 1' CONTOUR (E)
 - 5' CONTOUR (E)
 - PROPOSED CONTOUR
 - DS DOWNSPOUT
 - 3" MIN SOLID DRAIN PIPE
 - X65.68 EXISTING SPOT ELEVATION
 - X65.68 PROPOSED SPOT ELEVATION

- GENERAL NOTES**
- PLANS PREPARED AT THE REQUEST OF: RANDY MUKAEDA, OWNER
 - TOPOGRAPHY BY BGT LAND SURVEYING, SURVEYED AUGUST 2016.
 - THIS IS NOT A BOUNDARY SURVEY.
 - ELEVATION DATUM ASSUMED.

- GRADING NOTES**
- CUT VOLUME : 40 CY (FOR FOUNDATION, MINOR GRADING)
 FILL VOLUME: 0 CY
- ABOVE VOLUMES ARE APPROXIMATE.
 - ALL GRADING SHALL CONFORM TO LOCAL CODES AND ORDINANCES.
 - ALL TRENCHES IN PROPOSED LANDSCAPE AREAS SHALL BE BACKFILLED WITH COMPACTED APPROVED GRANULAR MATERIAL TO WITHIN ONE FOOT OF FINISHED GRADE, AND THEN FILLED WITH HAND TAMPED SOILS.

- DRAINAGE NOTES**
- DRAINAGE INTENT: IT IS THE INTENT OF THE DRAINAGE SYSTEM TO CONVEY ROOF RUNOFF TO A SAFE LOCATION, AND TO MINIMIZE EXCESSIVE MOISTURE AROUND FOUNDATIONS. DIRECT SLOPES SUCH THAT STORMWATER WILL NOT BE DIVERTED ONTO ADJACENT PROPERTIES.
 - ALL DOWNSPOUT DRAIN LINES SHALL LEAD TO DETENTION BASIN, AS SHOWN. THE DETENTION BASIN SHALL BE WATER-TIGHT AND DRAIN TO AN ENERGY DISSIPATER, AS SHOWN.
 - ALL ROOF DRAINAGE PIPES SHALL BE 3" DIAMETER MINIMUM SOLID PIPE, SLOPED AT 1% MINIMUM.
 - IT IS THE PROPERTY OWNER'S RESPONSIBILITY TO CHECK ON ALL STORMWATER FACILITIES SUCH AS ROOF GUTTERS, DOWNSPOUT LINES, AND THE DETENTION BASIN/ENERGY DISSIPATER TO BE SURE THAT THEY ARE CLEAR OF EXCESSIVE DEBRIS AND OPERATING EFFICIENTLY. THE FACILITIES SHALL BE CHECKED EVERY FALL AND PERIODICALLY DURING THE RAINY SEASON.

- TRAFFIC CONTROL NOTES**
- CONTRACTOR AND WORKERS SHALL PARK ALONG CYPRESS AVENUE.
 - WHEN TRUCKS PARK IN STREET FOR DELIVERY OF SUPPLIES AND CONCRETE, EVERY EFFORT SHALL BE MADE TO PROVIDE ROOM FOR VEHICLES TO PASS. WORKERS SHALL PROVIDE TRAFFIC CONTROL AT ALL TIMES WHEN ROAD IS PARTIALLY BLOCKED.

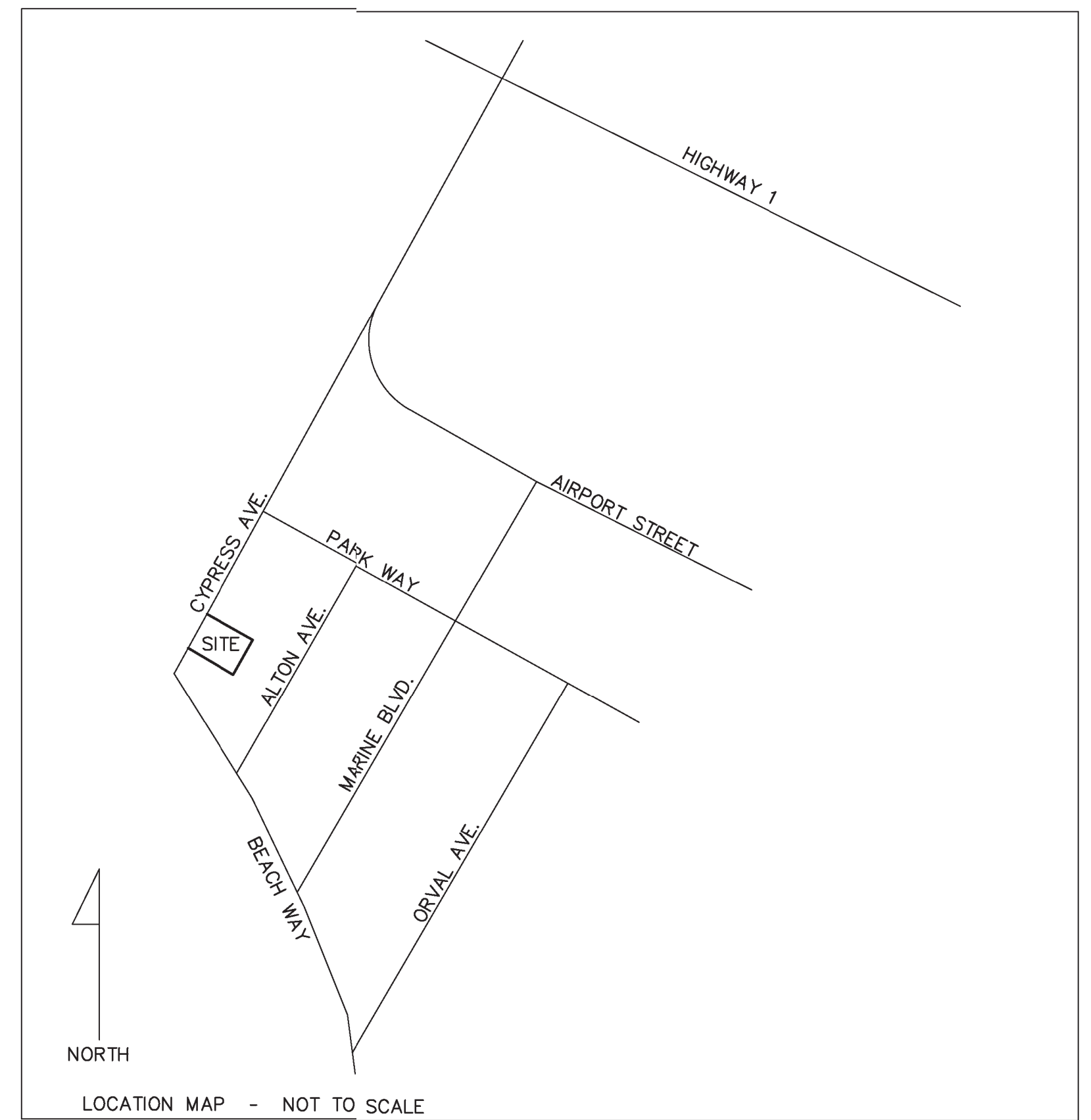

SECTION AND DETAIL CONVENTION

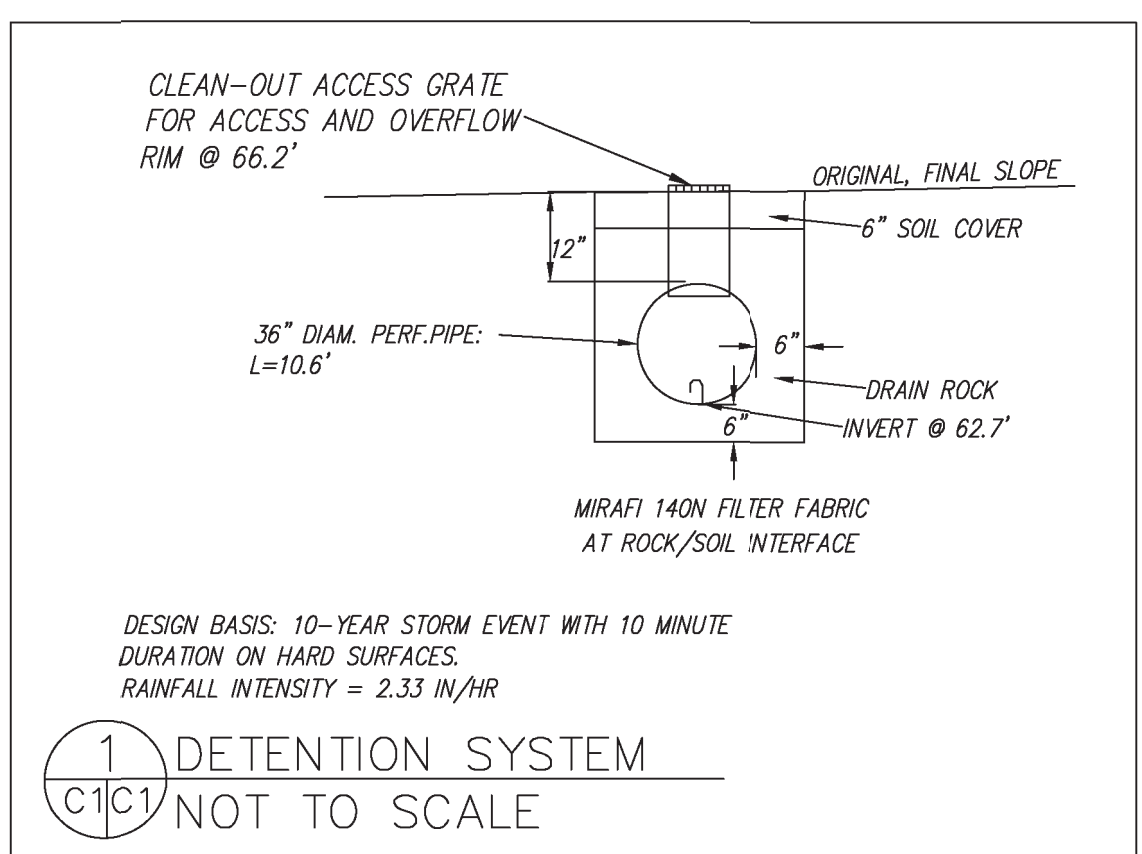
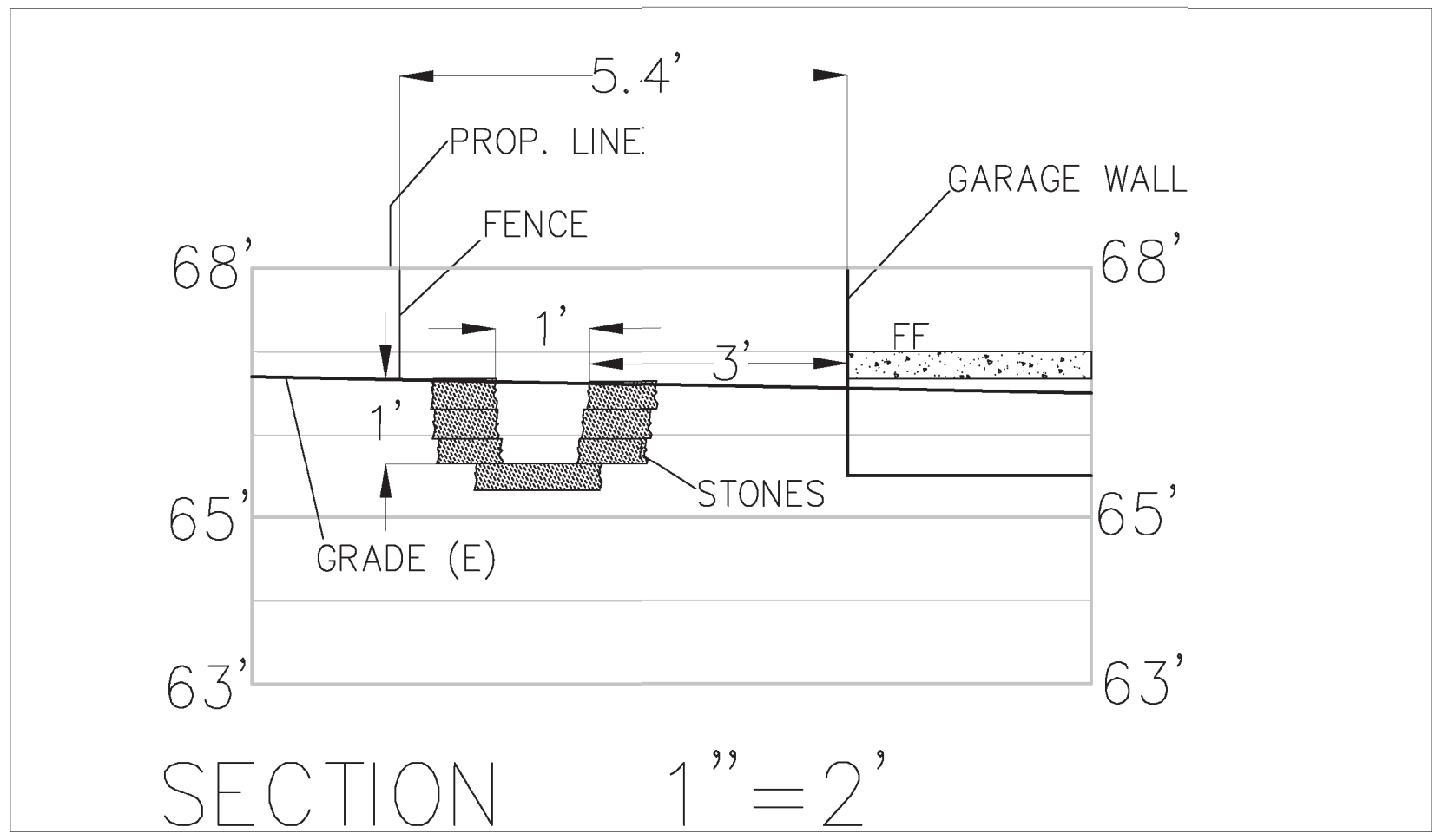
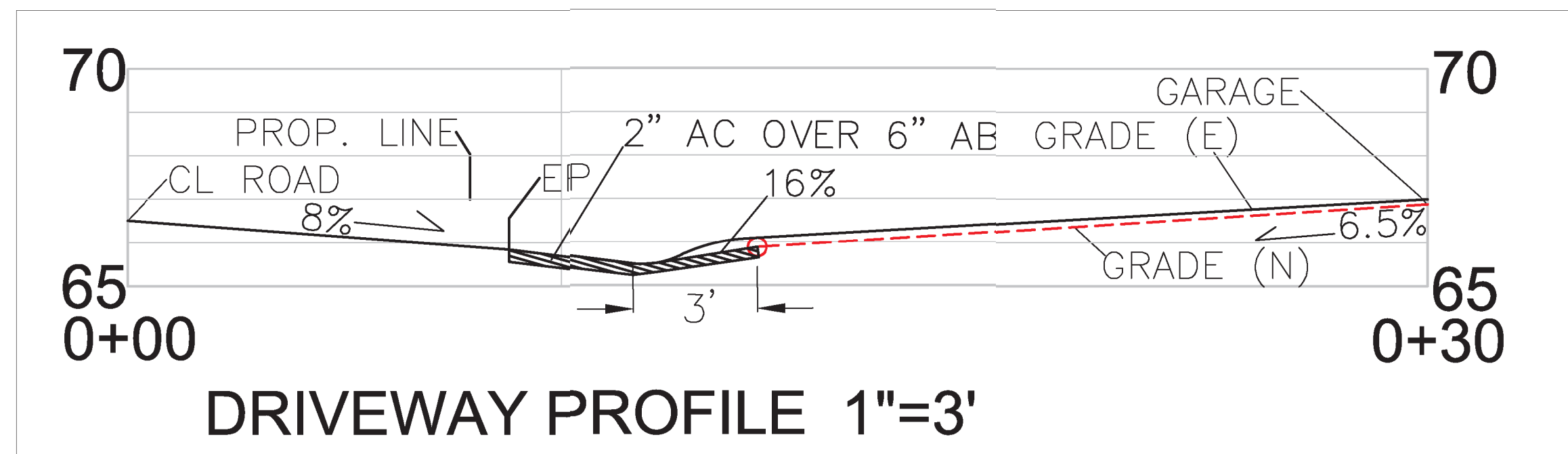
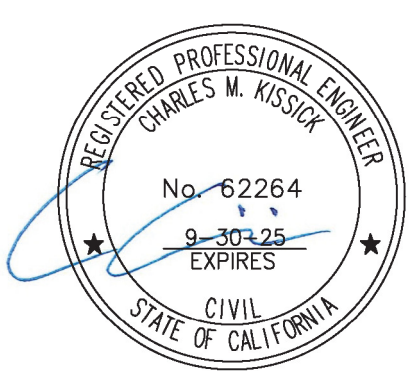
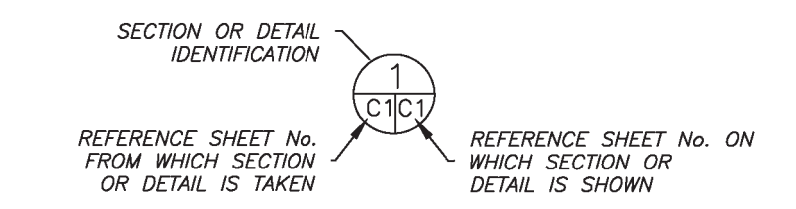

DATE: 4-3-19	DRAWN BY: CMK	CHECKED BY: AZG	REV. DATE: 6-18-20	REV. DATE: 6-23-20	REV. DATE: 7-30-20
Sigma Prime Geosciences, Inc.		SIGMA PRIME GEOSCIENCES, INC. 332 PRINCETON AVENUE HALF MOON BAY, CA 94019 (650) 728-3590 FAX 728-3593			
REGISTERED PROFESSIONAL ENGINEER CHARLES M. KUSSAK No. 62264 9-30-25 EXPIRES CIVIL STATE OF CALIFORNIA					

GRADING AND DRAINAGE PLAN
 MUKAEDA PROPERTY
 CYPRESS AVENUE
 MOSS BEACH
 APN 037-221-020,030

SHEET
C-1

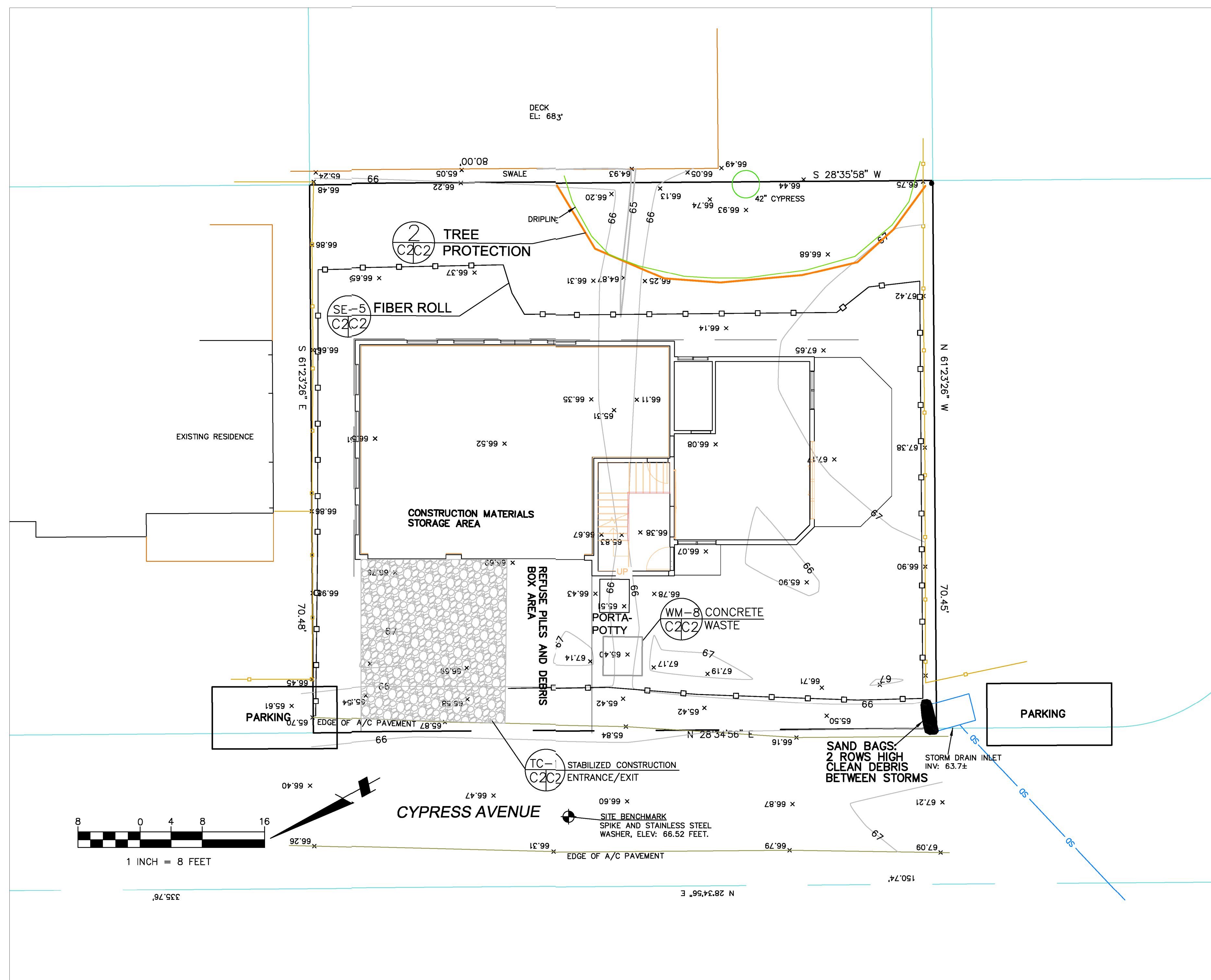

GENERAL EROSION AND SEDIMENT CONTROL NOTES

- There will be no stockpiling of soil. All excavated soil will be hauled off-site as it is excavated.
- Perform clearing and earth-moving activities only during dry weather. Measures to ensure adequate erosion and sediment control shall be installed prior to earth-moving activities and construction.
- Measures to ensure adequate erosion and sediment control are required year-round. Stabilize all denuded areas and maintain erosion control measures continuously between October 1 and April 30.
- Store, handle, and dispose of construction materials and wastes properly, so as to prevent their contact with stormwater.
- Control and prevent the discharge of all potential pollutants, including pavement cutting wastes, paints, concrete, petroleum products, chemicals, wash water or sediments, and non-stormwater discharges to storm drains and watercourses.
- Use sediment controls or filtration to remove sediment from dewatering site and obtain Regional Water Quality Control Board (RWQCB) permit(s) as necessary.
- Avoid cleaning, fueling, or maintaining vehicles on-site, except in a designated area where wash water is contained and treated.
- Limit and time applications of pesticides and fertilizers to prevent polluted runoff.
- Limit construction access routes to stabilized, designated access points
- Avoid tracking dirt or other materials off-site; clean off-site paved areas and sidewalks using dry sweeping methods.
- Train and provide instruction to all employees and subcontractors regarding the Watershed Protection Maintenance Standards and construction Best Management Practices.
- Placement of erosion materials is required on weekends and during rain events.
- The areas delineated on the plans for parking, grubbing, storage etc., shall not be enlarged or "run over."
- Dust control is required year-round.
- Erosion control materials shall be stored on-site
- The tree protection shall be in place before any grading, excavating or grubbing is started.

CONCRETE WASTE MANAGEMENT WM-8

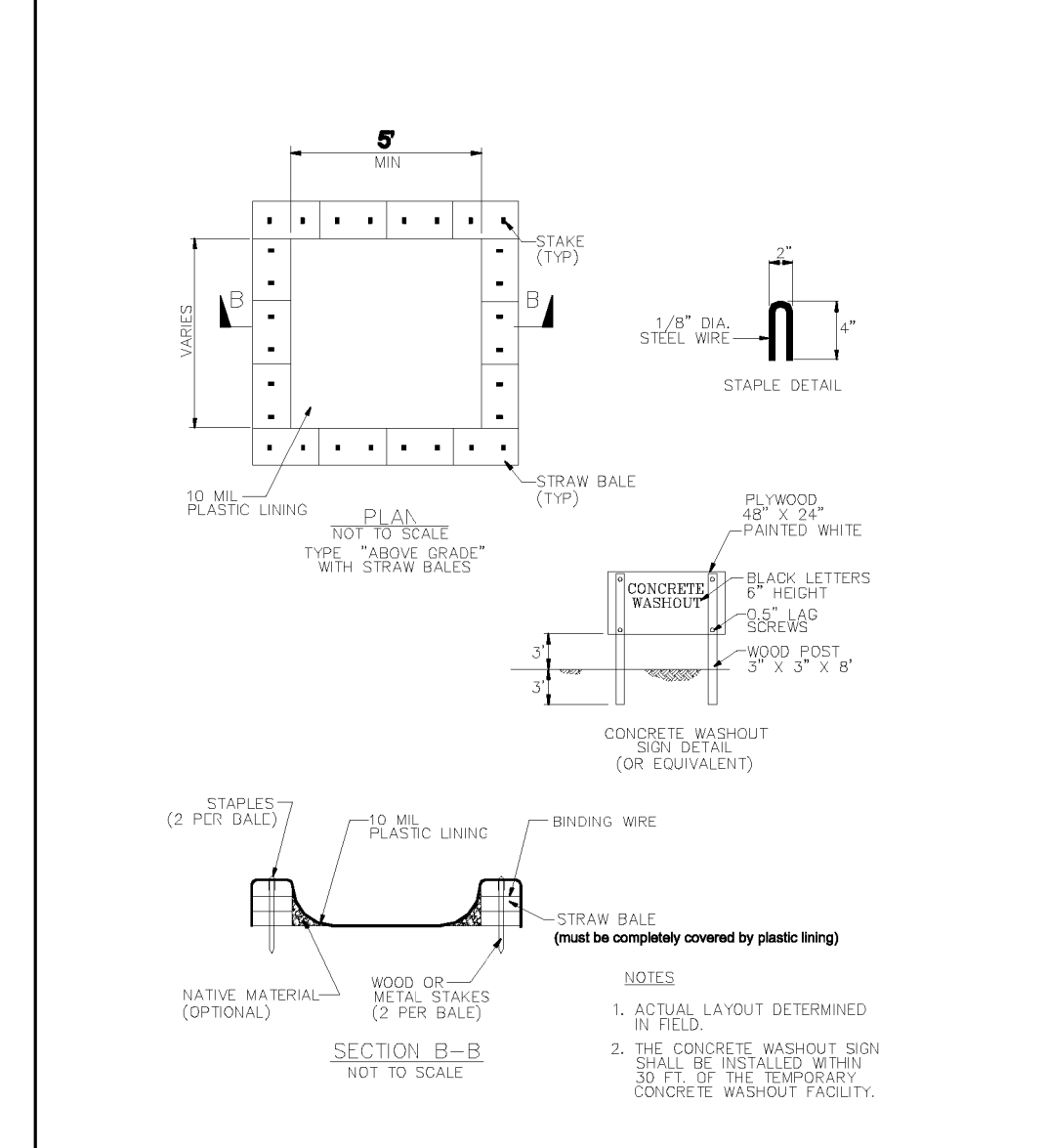

EROSION CONTROL POINT OF CONTACT

THIS PERSON WILL BE RESPONSIBLE FOR EROSION CONTROL AT THE SITE AND WILL BE THE COUNTY'S MAIN POINT OF CONTACT IF CORRECTIONS ARE REQUIRED.

NAME: RANDY MUKAEDA
 TITLE/QUALIFICATION: OWNER
 PHONE: 650-238-8306
 PHONE:
 E-MAIL: DRAGNFISH67@GMAIL.COM



USE OF PLASTIC SHEETING BETWEEN OCTOBER 1ST AND APRIL 30TH IS NOT ACCEPTABLE, UNLESS FOR USE ON STOCKPILES WHERE THE STOCKPILE IS ALSO PROTECTED WITH FIBER ROLLS CONTAINING THE BASE OF THE STOCKPILE.

TREE PROTECTION NOTES

1. TREE PROTECTION FENCING SHALL BE INSTALLED PRIOR TO ANY GRADING AND REMAIN ON-SITE THROUGHOUT CONSTRUCTION PROCESS.
2. TREE PROTECTION FENCES SHALL BE INSTALLED AS CLOSE TO DRIP LINES AS POSSIBLE.
3. OWNER/BUILDER SHALL MAINTAIN TREE PROTECTION ZONES FREE OF EQUIPMENT AND MATERIALS STORAGE AND SHALL NOT CLEAN ANY EQUIPMENT WITHIN THESE AREAS.
4. ANY LARGE ROOTS THAT NEED TO BE CUT SHALL BE INSPECTED BY A CERTIFIED ARBORIST OR REGISTERED FORESTER PRIOR TO CUTTING, AND MONITORED AND DOCUMENTED.
5. ROOTS TO BE CUT SHALL BE SEVERED WITH A SAW OR TOPPER.
6. PRE-CONSTRUCTION SITE INSPECTION WILL BE REQUIRED PRIOR TO ISSUANCE OF BUILDING PERMIT.

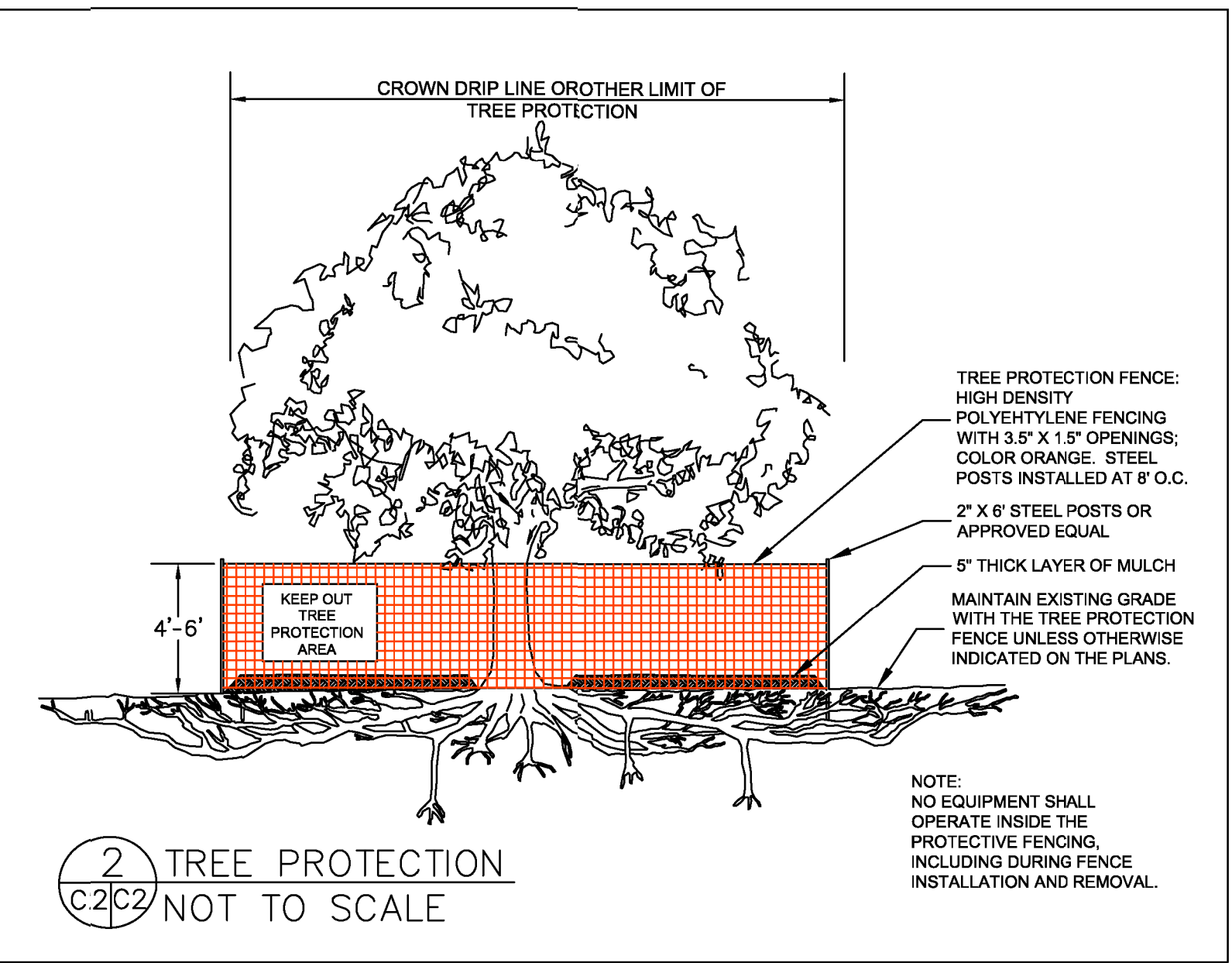

EROSION CONTROL NOTES

- FIBER ROLL INSTALL AT LOCATIONS SHOWN. AFFIX AS SHOWN IN DETAIL SE-5
1. GRADING MAY TAKE PLACE DURING WET WEATHER AFTER OCTOBER 1 PROVIDED THE FOLLOWING PROVISIONS ARE FOLLOWED.
 2. NO GRADING SHALL TAKE PLACE DURING RAINY WEATHER OR FOR A PERIOD OF AT LEAST 24 HOURS FOLLOWING RAIN.
 3. ALL EXPOSED SOIL SHALL BE TEMPORARILY PROTECTED FROM EROSION WITH JUTE NETTING.
 4. ALL STOCKPILED SOIL SHALL BE COVERED AT ALL TIMES AND REMOVED FROM SITE AS SOON AS POSSIBLE, IF SCHEDULED FOR OFF-HAUL.
 5. ALL EXPOSED SURFACES SHALL BE PERMANENTLY PROTECTED FROM EROSION WITH SEEDING AND/OR LANDSCAPING. SEED MIX SHALL BE 75 LB PER ACRE ANNUAL RYGRASS OR APPROVED SUBSTITUTE. SEED SHALL BE COVERED WITH STRAW MULCH AT A RATE OF 2 TONS/ACRE.
 6. ROCKED CONSTRUCTION ENTRANCE SHALL BE 40 FEET LONG BY 17 FEET WIDE AND CONFORM TO THE FOLLOWING:
 - A. THE MATERIAL FOR THE PAD SHALL BE 3 TO 6 INCH STONE.
 - B. PAD SHALL BE NOT LESS THAN 12" THICK.
 - C. THE ENTRANCE SHALL BE MAINTAINED IN A CONDITION THAT WILL PREVENT TRACKING OR FLOWING OF SEDIMENT ONTO PUBLIC RIGHT-OF-WAY. THIS MAY REQUIRE PERIODIC TOP DRESSING WITH ADDITIONAL STONE AS CONDITIONS DEMAND, AND REPAIR AND/OR CLEANOUT OF ANY MEASURES USED TO TRAP SEDIMENT. ALL SEDIMENT SPILLED, DROPPED, WASHED, OR TRACKED ONTO PUBLIC RIGHT-OF-WAY SHALL BE REMOVED IMMEDIATELY.
 - D. WHEN NECESSARY, WHEELS SHALL BE CLEANED TO REMOVE SEDIMENT PRIOR TO ENTRANCE ONTO PUBLIC RIGHT-OF-WAY. WHEN WASHING IS REQUIRED, IT SHALL BE DONE ON AN AREA THAT DRAINS TO THE CONCRETE WASHOUT AREA.
 7. CONCRETE WASHOUT AREA SHALL BE SURROUNDED BY A SINGLE LAYER OF SAND BAGS TO CONTAIN FLUIDS. CHANNEL INTO AREA SHALL BE CLEARED TO ALLOW TIRE DEBRIS (SEE NOTE 6.D. ABOVE)

FIBER ROLLS SE-5

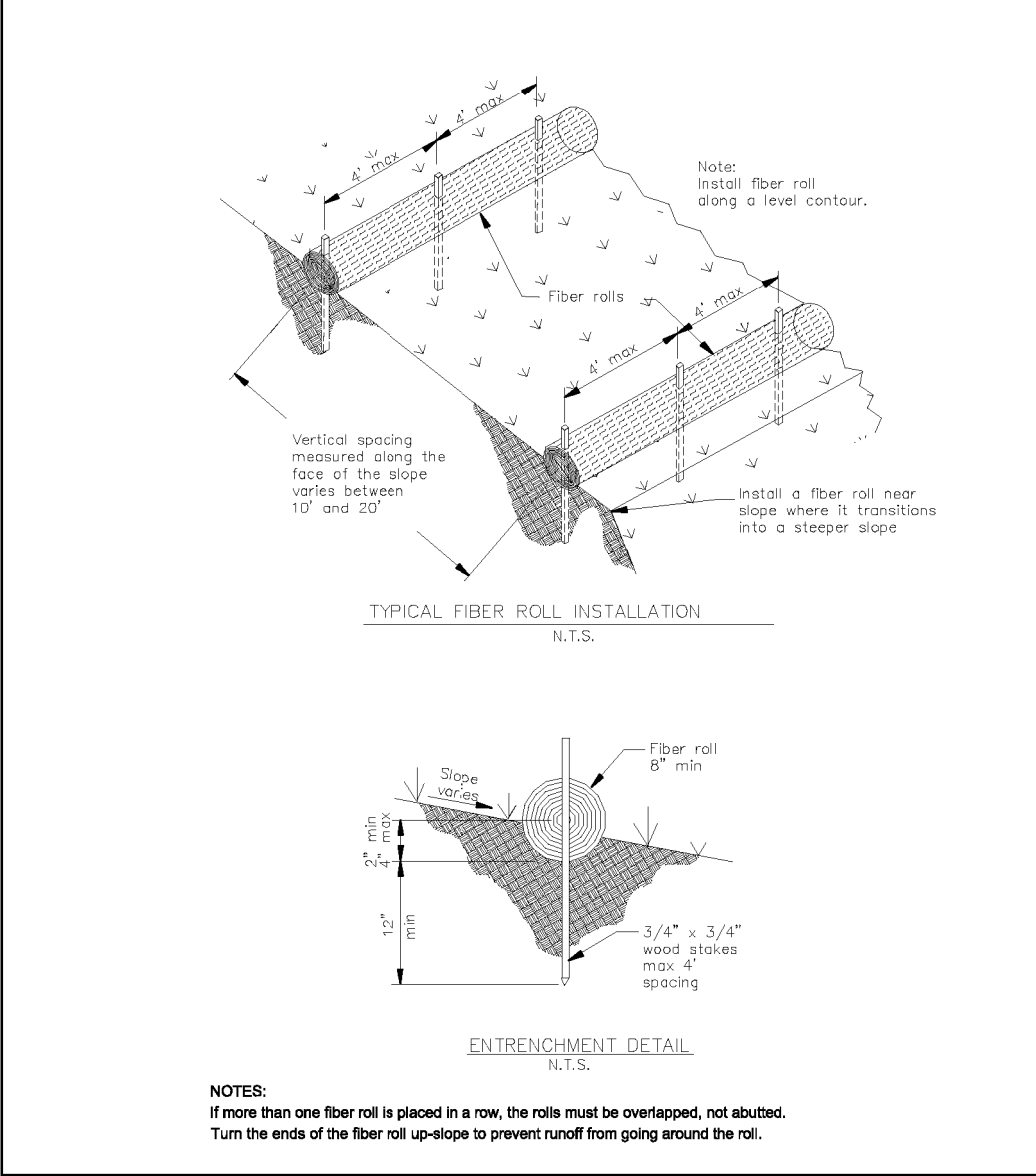

STABILIZED CONSTRUCTION ENTRANCE/EXIT TC-1

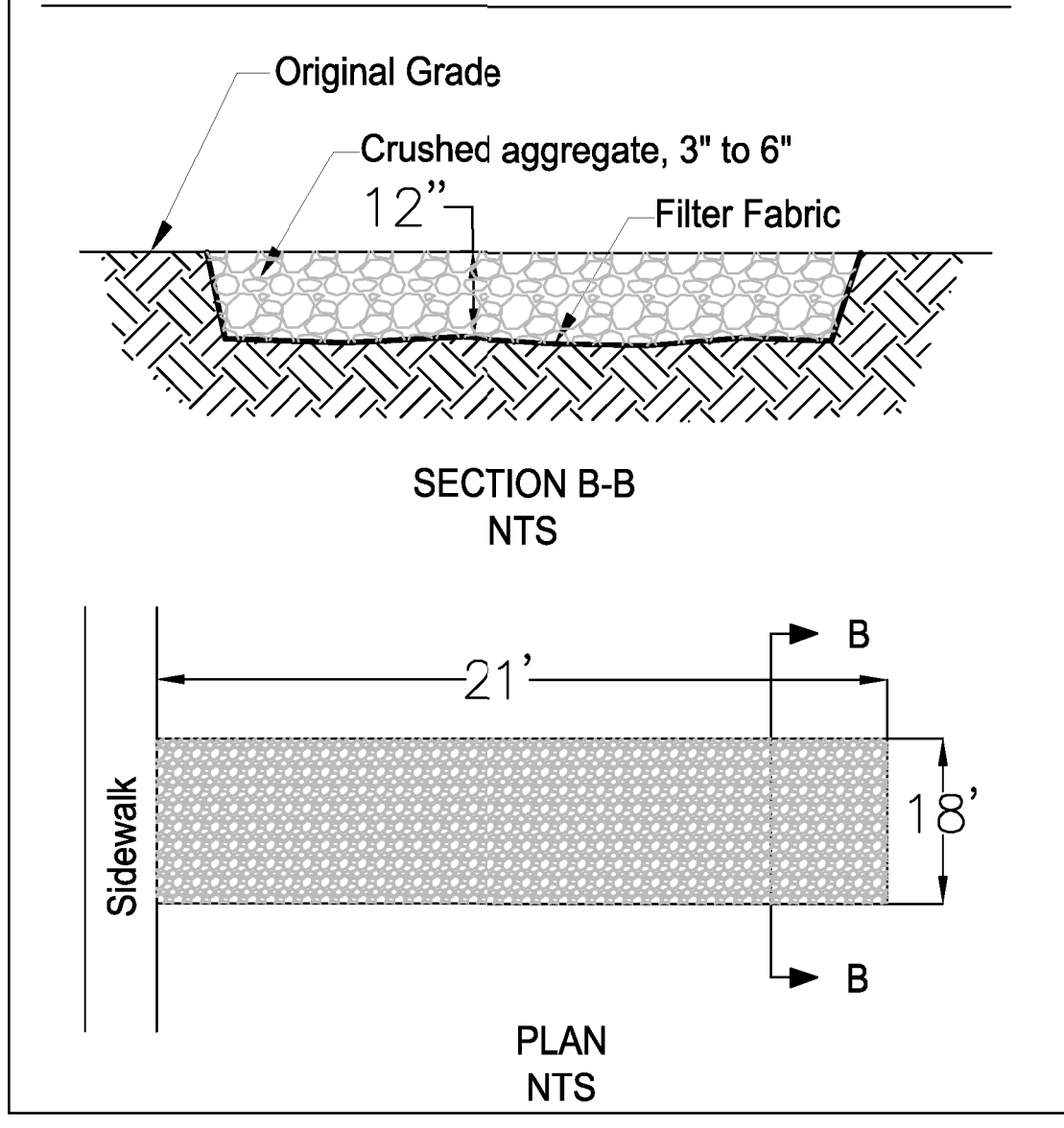

Sigma Prime Geosciences, Inc.
 SIGMA PRIME GEOSCIENCES, INC.
 330 PRINCETON AVENUE
 HALF MOON BAY, CA 94019
 (650) 728-3590
 FAX 728-3593

DATE: 4-3-19
 DRAWN BY: CMK
 CHECKED BY: AZG
 REV. DATE: 6-18-20
 REV. DATE:
 REV. DATE:

EROSION AND SEDIMENT CONTROL AND TREE PROTECTION PLAN
 MUKAEDA PROPERTY
 CYPRESS AVENUE
 MOSS BEACH
 APN 037-221-020,030

SHEET C-2



EDWARD C. LOVE, ARCHITECT

Edward C. Love
Architect
720 MILL STREET
HALF MOON BAY, CA 94019
(650) 728-7615
edwardclovearch@gmail.com

New Residence for
the Mukaeda family
Cypress Ave
Moss Beach, CA

Best Management
Practices

FOR
REVIEW
ONLY

DATE: 4/30/2024

SCALE:

DRAWN: Author

JOB: MUKAEDA

SHEET:

C3

OF SHEETS



Construction Best Management Practices (BMPs)

Construction projects are required to implement the stormwater best management practices (BMP) on this page, as they apply to your project, all year long.

Materials & Waste Management

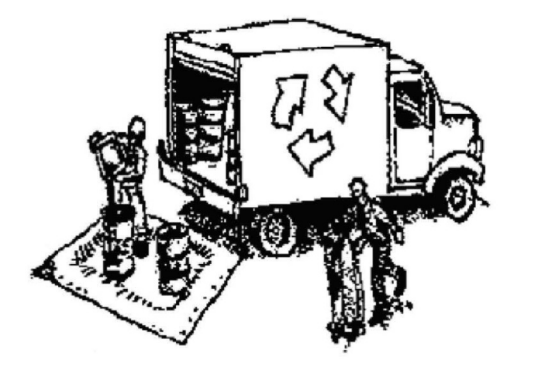

- Non-Hazardous Materials**
- Bern and cover stockpiles of sand, dirt or other construction material with tarps when rain is forecast or if not actively being used within 14 days.
 - Use (but don't overuse) reclaimed water for dust control.
- Hazardous Materials**
- Label all hazardous materials and hazardous wastes (such as pesticides, paints, thinners, solvents, fuel, oil, and antifreeze) in accordance with city, county, state and federal regulations.
 - Store hazardous materials and wastes in water tight containers, store in appropriate secondary containment, and cover them at the end of every work day or during wet weather or when rain is forecast.
 - Follow manufacturer's application instructions for hazardous materials and be careful not to use more than necessary. Do not apply chemicals outdoors when rain is forecast within 24 hours.
 - Arrange for appropriate disposal of all hazardous wastes.
- Waste Management**
- Cover waste disposal containers securely with tarps at the end of every work day and during wet weather.
 - Check waste disposal containers frequently for leaks and to make sure they are not overfilled. Never hose down a dumpster on the construction site.
 - Clean or replace portable toilets, and inspect them frequently for leaks and spills.
 - Dispose of all wastes and debris properly. Recycle materials and wastes that can be recycled (such as asphalt, concrete, aggregate base materials, wood, gypsum board, pipe, etc.)
 - Dispose of liquid residues from paints, thinners, solvents, glues, and cleaning fluids as hazardous waste.
- Construction Entrances and Perimeter**
- Establish and maintain effective perimeter controls and stabilize all construction entrances and exits to sufficiently control erosion and sediment discharges from site and tracking off site.
 - Sweep or vacuum any street tracking immediately and secure sediment source to prevent further tracking. Never hose down streets to clean up tracking.

Equipment Management & Spill Control

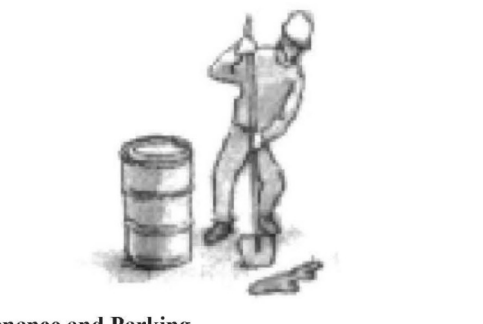

- Maintenance and Parking**
- Designate an area, fitted with appropriate BMPs, for vehicle and equipment parking and storage.
 - Perform major maintenance, repair jobs, and vehicle and equipment washing off site.
 - If refueling or vehicle maintenance must be done onsite, work in a bermed area away from storm drains and over a drip pan or drop cloths big enough to collect fluids. Recycle or dispose of fluids as hazardous waste.
 - If vehicle or equipment cleaning must be done onsite, clean with water only in a bermed area that will not allow rinse water to run into gutters, streets, storm drains, or surface waters.
 - Do not clean vehicle or equipment onsite using soaps, solvents, degreasers, or steam cleaning equipment.
- Spill Prevention and Control**
- Keep spill cleanup materials (e.g., rags, absorbents and cat litter) available at the construction site at all times.
 - Inspect vehicles and equipment frequently for and repair leaks promptly. Use drip pans to catch leaks until repairs are made.
 - Clean up spills or leaks immediately and dispose of cleanup materials properly.
 - Do not hose down surfaces where fluids have spilled. Use dry cleanup methods (absorbent materials, cat litter, and/or rags).
 - Sweep up spilled dry materials immediately. Do not try to wash them away with water, or bury them.
 - Clean up spills on dirt areas by digging up and properly disposing of contaminated soil.
 - Report significant spills immediately. You are required by law to report all significant releases of hazardous materials, including oil. To report a spill: 1) Dial 911 or your local emergency response number, 2) Call the Governor's Office of Emergency Services Warning Center, (800) 852-7550 (24 hours).

Earthmoving

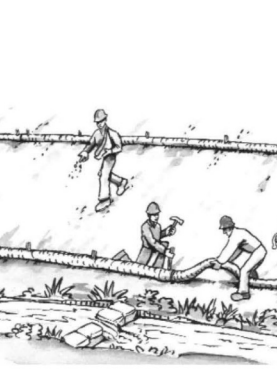

- Schedule grading and excavation work during dry weather.
- Stabilize all denuded areas, install and maintain temporary erosion controls (such as erosion control fabric or bonded fiber matrix) until vegetation is established.
- Remove existing vegetation only when absolutely necessary, and seed or plant vegetation for erosion control on slopes or where construction is not immediately planned.
- Prevent sediment from migrating offsite and protect storm drain inlets, gutters, ditches, and drainage courses by installing and maintaining appropriate BMPs, such as fiber rolls, silt fences, sediment basins, gravel bags, berms, etc.
- Keep excavated soil on site and transfer it to dump trucks on site, not in the streets.

Paving/Asphalt Work

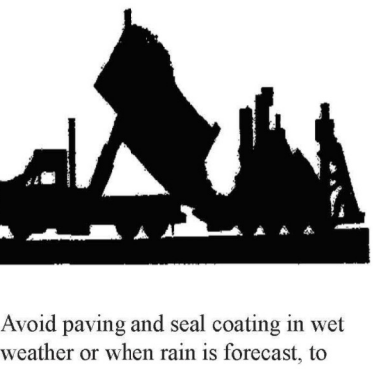

- Avoid paving and seal coating in wet weather or when rain is forecast, to prevent materials that have not cured from contacting stormwater runoff.
- Cover storm drain inlets and manholes when applying seal coat, tack coat, slurry seal, fog seal, etc.
- Collect and recycle or appropriately dispose of excess abrasive gravel or sand. Do NOT sweep or wash it into gutters.
- Do not use water to wash down fresh asphalt concrete pavement.

Concrete, Grout & Mortar Application

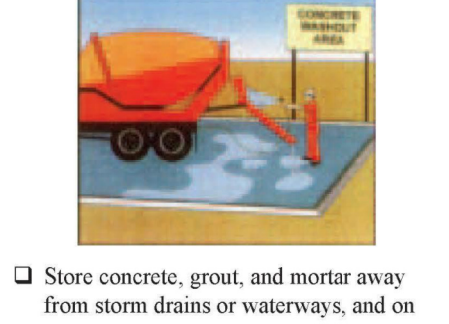

- Store concrete, grout, and mortar away from storm drains or waterways, and on pallets under cover to protect them from rain, runoff, and wind.
- Wash out concrete equipment/trucks offsite or in a designated washout area, where the water will flow into a temporary waste pit, and in a manner that will prevent leaching into the underlying soil or onto surrounding areas. Let concrete harden and dispose of as garbage.
- When washing exposed aggregate, prevent washwater from entering storm drains. Block any inlets and vacuum gutters, hose washwater onto dirt areas, or drain onto a bermed surface to be pumped and disposed of properly.

Landscaping

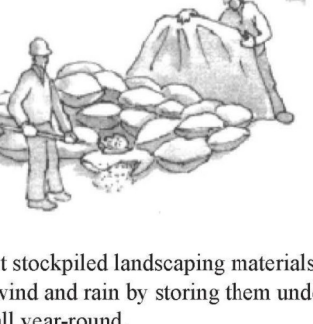

- Protect stockpiled landscaping materials from wind and rain by storing them under tarps all year-round.
- Stack bagged material on pallets and under cover.
- Discontinue application of any erodible landscape material within 2 days before a forecast rain event or during wet weather.

Painting & Paint Removal

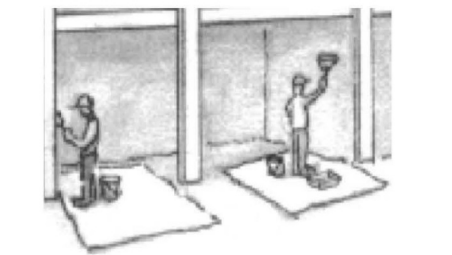

- Painting Cleanup and Removal**
- Never clean brushes or rinse paint containers into a street, gutter, storm drain, or stream.
 - For water-based paints, paint out brushes to the extent possible, and rinse into a drain that goes to the sanitary sewer. Never pour paint down a storm drain.
 - For oil-based paints, paint out brushes to the extent possible and clean with thinner or solvent in a proper container. Filter and reuse thinners and solvents. Dispose of excess liquids as hazardous waste.
 - Paint chips and dust from non-hazardous dry stripping and sand blasting may be swept up or collected in plastic drop cloths and disposed of as trash.
 - Chemical paint stripping residue and chips and dust from marine paints or paints containing lead, mercury, or tributyltin must be disposed of as hazardous waste. Lead based paint removal requires a state-certified contractor.

Dewatering

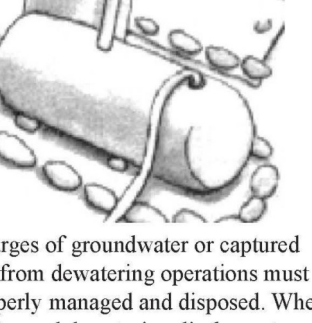

- Discharges of groundwater or captured runoff from dewatering operations must be properly managed and disposed. When possible send dewatering discharge to landscaped area or sanitary sewer. If discharging to the sanitary sewer call your local wastewater treatment plant.
- Divert run-on water from offsite away from all disturbed areas.
- When dewatering, notify and obtain approval from the local municipality before discharging water to a street gutter or storm drain. Filtration or diversion through a basin, tank, or sediment trap may be required.
- In areas of known or suspected contamination, call your local agency to determine whether the ground water must be tested. Pumped groundwater may need to be collected and hauled off-site for treatment and proper disposal.



Requirements for Architectural Copper

Protect water quality during installation, cleaning, treating, and washing!

Copper from Buildings May Harm Aquatic Life

Copper can harm aquatic life in San Francisco Bay. Water that comes into contact with architectural copper may contribute to impacts, especially during installation, cleaning, treating, or washing. Patination solutions that are used to obtain the desired shade of green or brown typically contain acids. After treatment, when the copper is rinsed to remove these acids, the rinse water is a source of pollutants. Municipalities prohibit discharges to the storm drain of water used in the installation, cleaning, treating and washing of architectural copper.



Building with copper flashing, gutter and drainpipe.

Use Best Management Practices (BMPs)

The following Best Management Practices (BMPs) must be implemented to prevent prohibited discharges to storm drains.

During Installation

- If possible, purchase copper materials that have been pre-patinated at the factory.
- If patination is done on-site, implement one or more of the following BMPs:
 - Discharge the rinse water to landscaping. Ensure that the rinse water does not flow to the street or storm drain. Block off storm drain inlet if needed.
 - Collect rinse water in a tank and pump to the sanitary sewer. Contact your local sanitary sewer agency before discharging to the sanitary sewer.
 - Collect the rinse water in a tank and haul off-site for proper disposal.
- Consider coating the copper materials with an impervious coating that prevents further corrosion and runoff. This will also maintain the desired color for a longer time, requiring less maintenance.



Storm drain inlet is blocked to prevent prohibited discharge. The water must be pumped and disposed of properly.

During Maintenance

Implement the following BMPs during routine maintenance activities, such as power washing the roof, re-patination or re-application of impervious coating:

- Block storm drain inlets as needed to prevent runoff from entering storm drains.
- Discharge the wash water to landscaping or to the sanitary sewer (with permission from the local sanitary sewer agency). If this is not an option, haul the wash water off-site for proper disposal.

Protect the Bay/Ocean and yourself!

If you are responsible for a discharge to the storm drain of non-stormwater generated by installing, cleaning, treating or washing copper architectural features, you are in violation of the municipal stormwater ordinance and may be subject to a fine.



Photo credit: Don Edwards National Wildlife Sanctuary

Contact Information

The San Mateo Countywide Water Pollution Prevention Program lists municipal stormwater contacts at www.flowstobay.org (click on "Business", then "New Development", then "local permitting agency").

FINAL February 29, 2012

Storm drain polluters may be liable for fines of up to \$10,000 per day!

S:\Client Projects 2017\Mukaeda\Revit\Mukaeda-V03.rvt

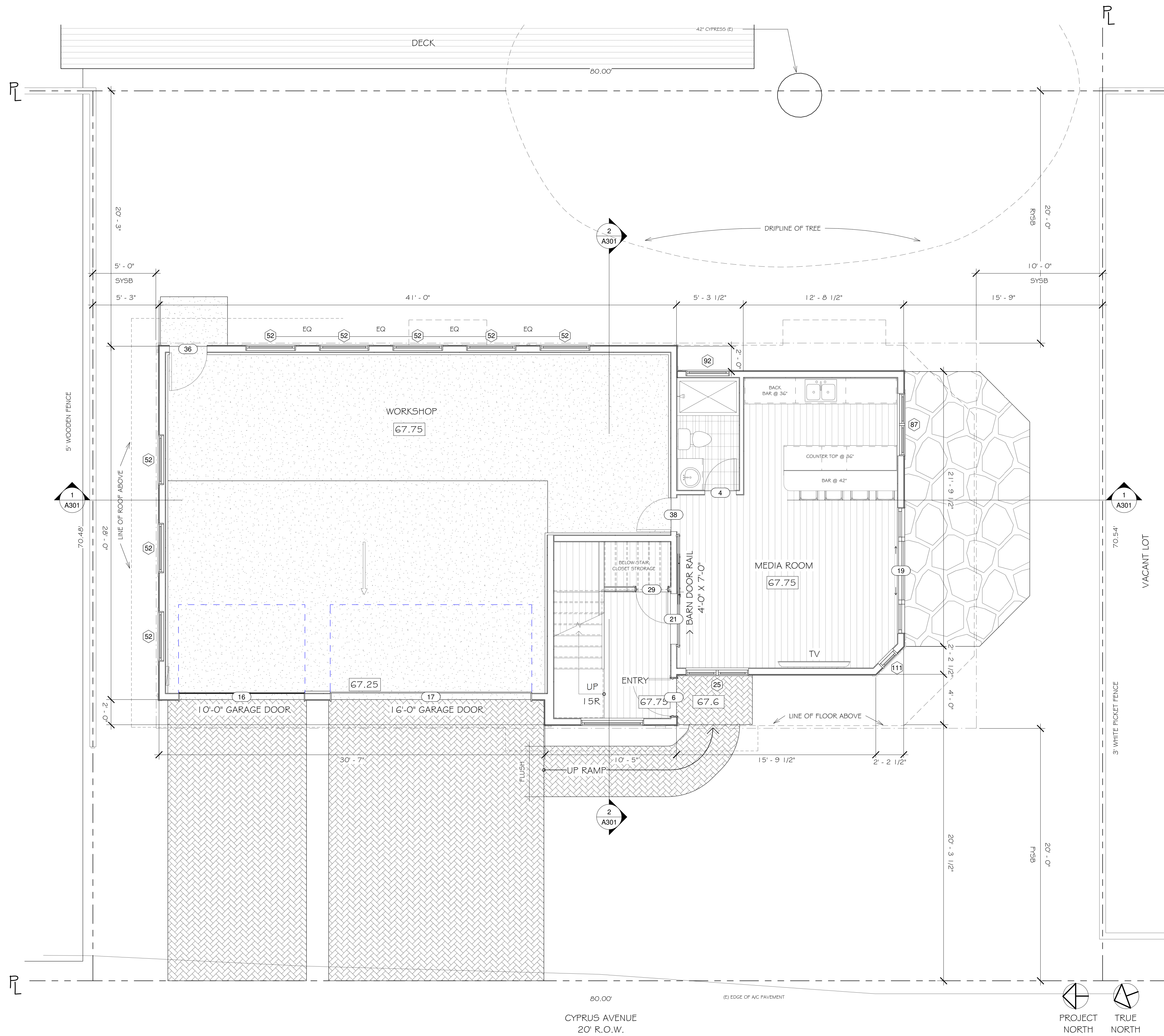

1 First Floor
1/4" = 1'-0"

REVISIONS

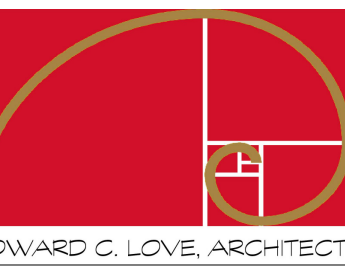

Edward C. Love
Architect
720 MILL STREET
HALF MOON BAY, CA 94019
(650) 728-7615
edwardclovearch@gmail.com

New Residence for
the Mukaeda family
Cypress Ave
Moss Beach, CA

First Floor Plan

FOR
REVIEW
ONLY

DATE: 4/30/2024
SCALE: 1/4" = 1'-0"
DRAWN: GMH
JOB: MUKAEDA

SHEET:
A101

OF SHEETS

S:\Client Projects 2017\Mukaeda\Revit\Mukaeda-V03.rvt

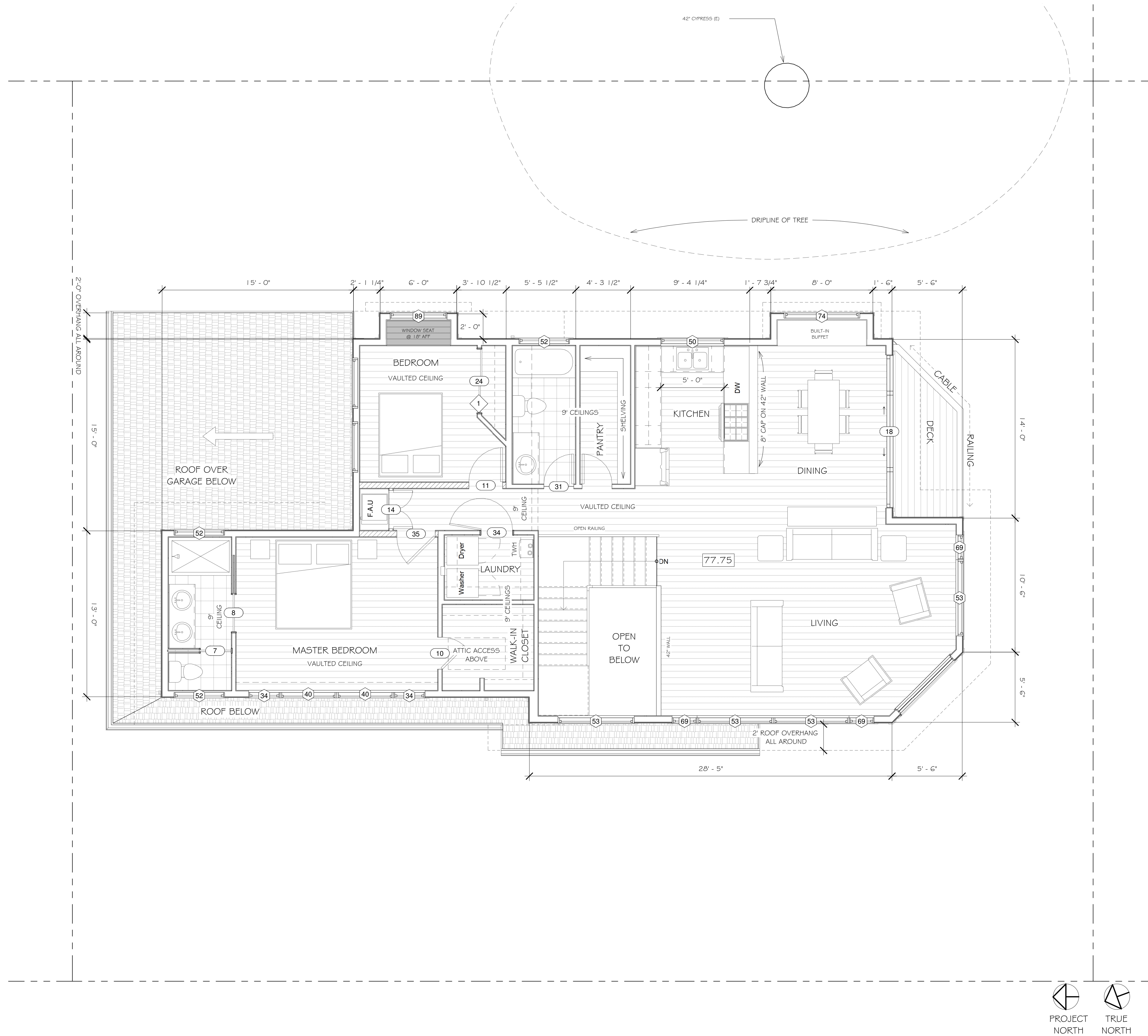

1 Second Floor
1/4" = 1'-0"

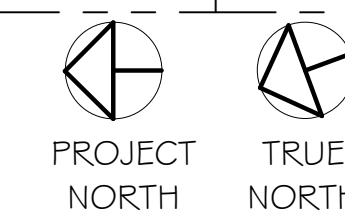

REVISIONS

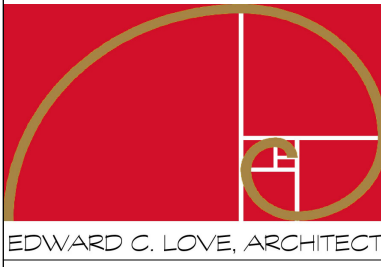

Edward C. Love
Architect
720 MILL STREET
HALF MOON BAY, CA 94019
(650) 728-7615
edwardclovearch@gmail.com

New Residence for
the Mukaeda family
Cypress Ave
Moss Beach, CA

Second Floor Plan

FOR
REVIEW
ONLY

DATE: 4/30/2024

SCALE: 1/4" = 1'-0"

DRAWN: GMH

JOB: MUKAEDA

SHEET:

A102

OF SHEETS

S:\Client Projects 2017\Mukaeda\Revit\Mukaeda-V03.rvt

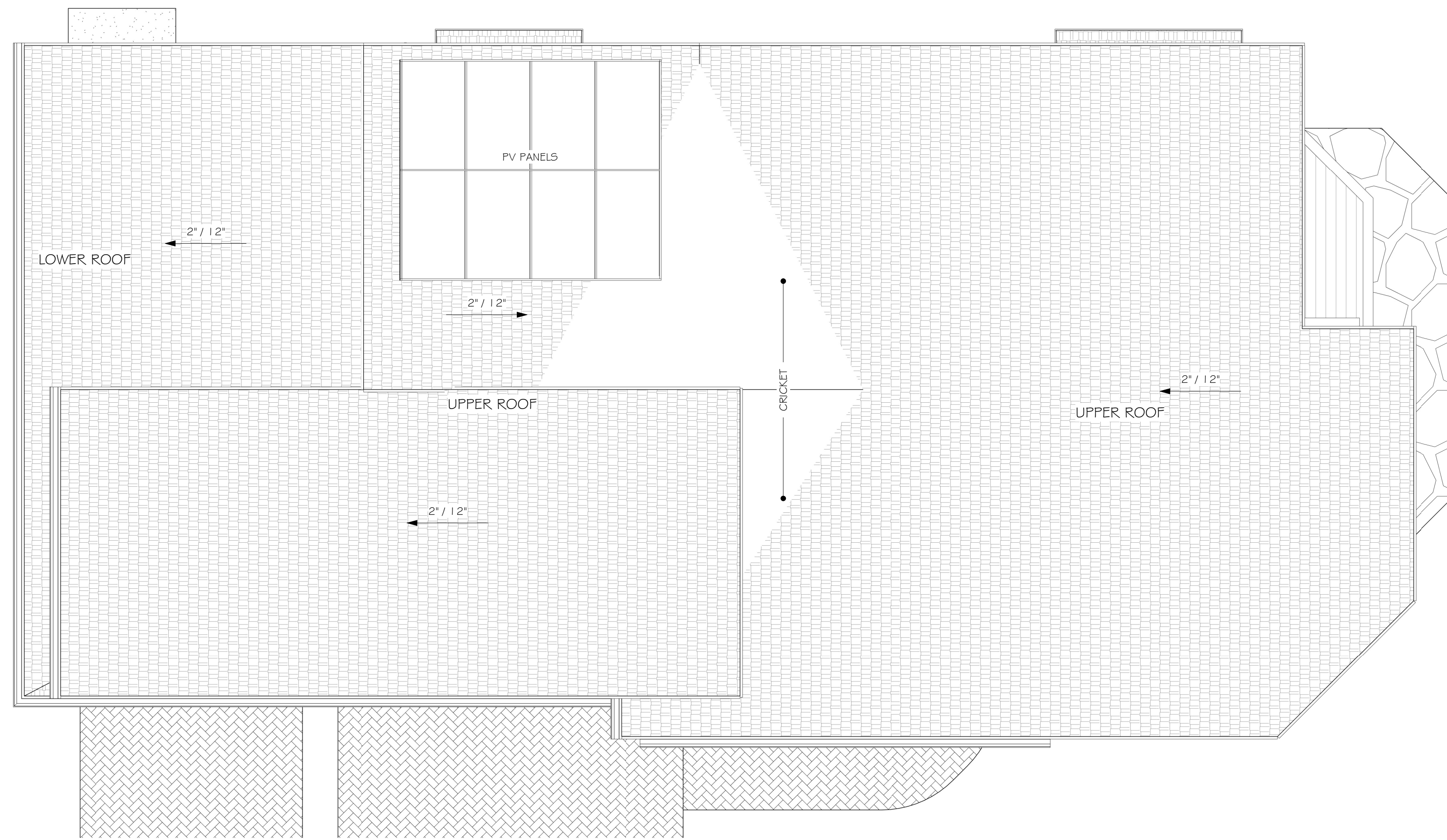

1 Roof Plan
1/4" = 1'-0"

REVISIONS



EDWARD C. LOVE, ARCHITECT

Edward C. Love
Architect
720 MILL STREET
HALF MOON BAY, CA 94019
(650) 728-7615
edwardclovearch@gmail.com

New Residence for
the Mukaeda family
Cypress Ave
Moss Beach, CA

Roof Plan

FOR REVIEW ONLY

DATE: 4/30/2024

SCALE: 1/4" = 1'-0"

DRAWN: GMH

JOB: MUKAEDA

SHEET:

A103

OF SHEETS

Door Schedule

Mark	Count	Location	Door Type	Width	Height	Comments
------	-------	----------	-----------	-------	--------	----------

LVL-1 1st Flr.

4	1	1st Floor Bath	Hollow Core	2' - 6"	7' - 0"	
6	1	Entry	Solid Core	3' - 0"	7' - 0"	
16	1	Garage	Garage Door	10' - 0"	8' - 0"	
17	1	Garage	Garage Door	16' - 0"	8' - 0"	
19	1	Media Room	4 Panel Sliding Glass	10' - 0"	7' - 1 1/2"	
21	1	Media Room	Barn Door	4' - 0"	7' - 0"	
29	1	Entry	Hollow Core	2' - 6"	6' - 8"	
36	1	Garage	Solid Core	3' - 0"	6' - 8"	
38	1	Media Room	Solid Core	2' - 8"	6' - 8"	20-minute fire rated, self-closing, smoke strip

LVL-2 2nd Flr.

7	1	Master Bath	Pocket Door	2' - 6"	6' - 8"	
8	1	Master Bath	Pocket Door	3' - 0"	6' - 8"	
10	1	Master Bedroom	Hollow Core	2' - 6"	7' - 0"	
11	1	Bedroom	Hollow Core	2' - 8"	7' - 0"	
14	1	2nd Floor Hall	Louvered Door	3' - 0"	7' - 0"	
15	1			0' - 0"	0' - 0"	
18	1	Dining Area	4 Panel Sliding Glass	12' - 0"	8' - 0"	
24	1	Bedroom	Double Bypass	5' - 0"	6' - 8"	
31	1	2nd Floor Bath	Hollow Core	2' - 4"	7' - 0"	
34	1	2nd Floor Hall	Hollow Core	2' - 6"	6' - 8"	
35	1	Master Bedroom	Hollow Core	3' - 0"	6' - 8"	
37	1	Pantry	Hollow Core	2' - 4"	7' - 0"	

Window Schedule

Mark	Rough Width	Rough Height	Sill Height	Temp. Glass	Egress	Type	Comments
------	-------------	--------------	-------------	-------------	--------	------	----------

LVL-0 Garage Flr @ Doors

28	5' - 0"	5' - 0"	2' - 11 1/2"				
52	4' - 0"	3' - 0"	5' - 6"			Awning	
52	4' - 0"	3' - 0"	5' - 6"			Awning	
52	4' - 0"	3' - 0"	5' - 6"			Awning	
52	4' - 0"	3' - 0"	5' - 6"			Awning	
52	4' - 0"	3' - 0"	5' - 6"			Awning	
52	4' - 0"	3' - 0"	5' - 6"			Awning	
52	4' - 0"	3' - 0"	5' - 6"			Awning	
52	4' - 0"	3' - 0"	5' - 6"			Awning	

LVL-1 1st Flr.

25	5' - 0"	5' - 0"	3' - 0"	Yes		Single Fixed, Single Casement	
87	5' - 0"	5' - 0"	3' - 0"			Double Casement	
92	3' - 6"	3' - 0"	5' - 0"			Awning	Obscured Glass
111	1' - 8"	7' - 0"	1' - 0"	Yes		Fixed	

LVL-2 2nd Flr.

34	2' - 6"	5' - 0"	3' - 0"		Yes	Casement, Confirm Swing	
34	2' - 6"	5' - 0"	3' - 0"		Yes	Casement, Confirm Swing	
40	4' - 6"	5' - 0"	3' - 0"				
40	4' - 6"	5' - 0"	3' - 0"				
50	5' - 0"	4' - 6"	3' - 6"			Double Casement	
52	4' - 0"	3' - 0"	5' - 0"			Awning	Obscured Glass
52	4' - 0"	3' - 0"	5' - 0"			Awning	Obscured Glass
52	4' - 0"	3' - 0"	5' - 0"			Awning	Obscured Glass
53	6' - 0"	7' - 6"	0' - 6"			Fixed	
53	6' - 0"	7' - 6"	0' - 6"			Fixed	
53	6' - 0"	7' - 6"	0' - 6"			Fixed	
53	6' - 0"	7' - 6"	0' - 6"			Fixed	
69	2' - 0"	7' - 6"	3' - 0"			Single Fixed, Single Casement	
69	2' - 0"	7' - 6"	3' - 0"			Single Fixed, Single Casement	
69	2' - 0"	7' - 6"	3' - 0"			Single Fixed, Single Casement	
74	6' - 0"	1' - 6"	6' - 6"			Fixed	
89	4' - 6"	5' - 0"	3' - 0"	Yes		Single Fixed, Single Casement	
112	4' - 0"	4' - 0"	4' - 0"				
112	4' - 0"	4' - 0"	4' - 0"				

LVL-2 Top

71	6' - 0"	3' - 6"	0' - 0"			Fixed	
71	6' - 0"	3' - 6"	0' - 0"			Fixed	
75	2' - 0"		0' - 0"			Custom Polygon Window	Measure Angle in Field
75	2' - 0"		0' - 0"			Custom Polygon Window	Measure Angle in Field
75	2' - 0"		0' - 0"			Custom Polygon Window	
75	2' - 0"		0' - 0"			Custom Polygon Window	
78	8' - 0"	4' - 8"	0' - 0"			Fixed	
113	2' - 0"		-8' - 6"				Measure Angle in Field

REVISIONS

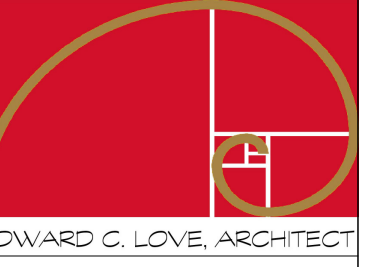

EDWARD C. LOVE, ARCHITECT

Edward C. Love
Architect
720 MILL STREET
HALF MOON BAY, CA 94019
(650) 728-7615
edwardclovearch@gmail.com

New Residence for
the Mukaeda family
Cypress Ave
Moss Beach, CA

Door & Window Schedule

**FOR
REVIEW
ONLY**

DATE: 4/30/2024

SCALE:

DRAWN: GMH

JOB: MUKAEDA

SHEET:

A104

OF SHEETS

REVISIONS

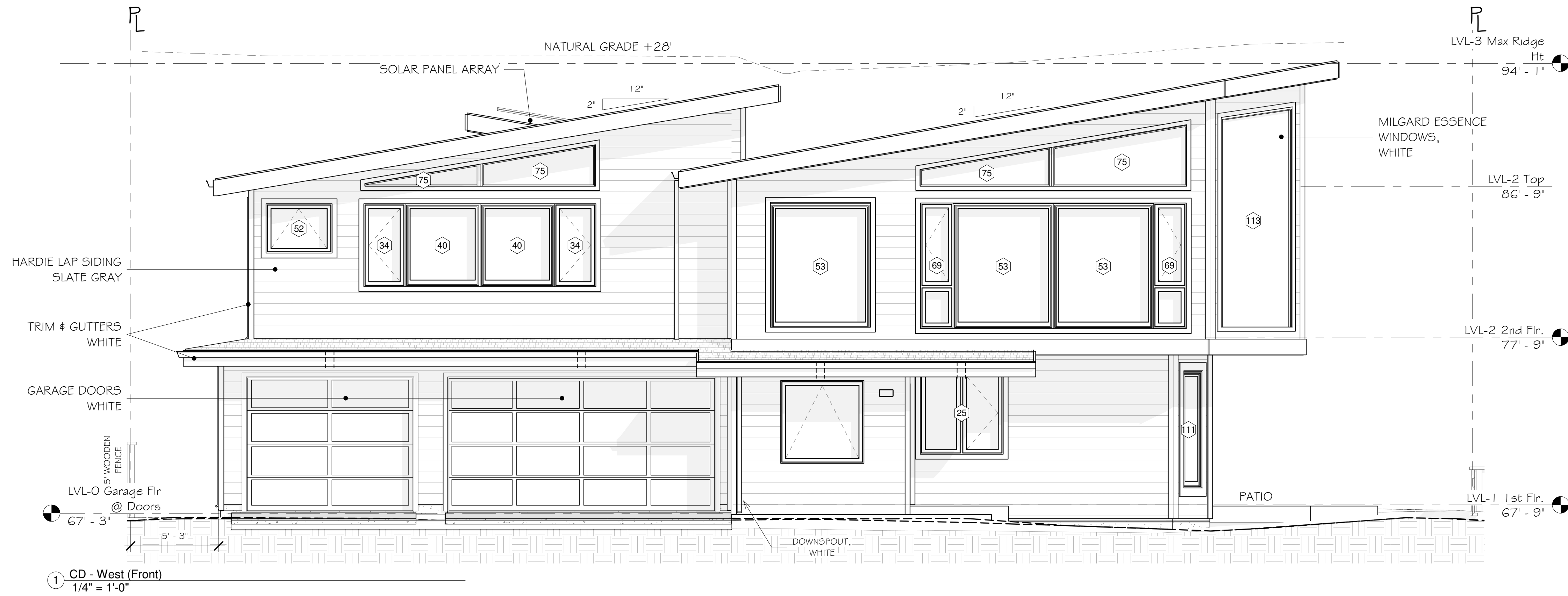

Attic Ventilation Calculation:
 Attic Area (AA) 135.0 sqft
 Ventilation Required (AA/150) 0.9 sqft
 Number of 4' x 16" (.44 sqft) Vents 3

ILLUMINATED ADDRESS
 DENOTES DOWNLIGHT IN OVERHANG (NO OTHER EXTERIOR LIGHTING)



Edward C. Love
 Architect
 720 MILL STREET
 HALF MOON BAY, CA 94019
 (650) 728-7615
 edwardclovearch@gmail.com

New Residence for
 the Mukaeda family
 Cypress Ave
 Moss Beach, CA

Elevations - West &
 South

FOR
 REVIEW
 ONLY

DATE: 4/30/2024
 SCALE: 1/4" = 1'-0"
 DRAWN: GMH
 JOB: MUKAEDA

SHEET:
A201

OF SHEETS

S:\Client Projects 2017\Mukaeda\Revit\Mukaeda-V03.rvt

REVISIONS



Edward C. Love
Architect
720 MILL STREET
HALF MOON BAY, CA 94019
(650) 728-7615
edwardclovearch@gmail.com

New Residence for
the Mukaeda family
Cypress Ave
Moss Beach, CA

Elevations - East &
North

FOR
REVIEW
ONLY

DATE: 4/30/2024

SCALE: 1/4" = 1'-0"

DRAWN: GMH

JOB: MUKAEDA

SHEET:

A202

OF SHEETS

Attic Ventilation Calculation:
Attic Area (AA) 135.0 sqft
Ventilation Required (AA/150) 0.9 sqft
Number of 4" x 16" (.44 sqft) Vents 3

ILLUMINATED ADDRESS
DENOTES DOWNLIGHT
IN OVERHANG
(NO OTHER EXTERIOR
LIGHTING)

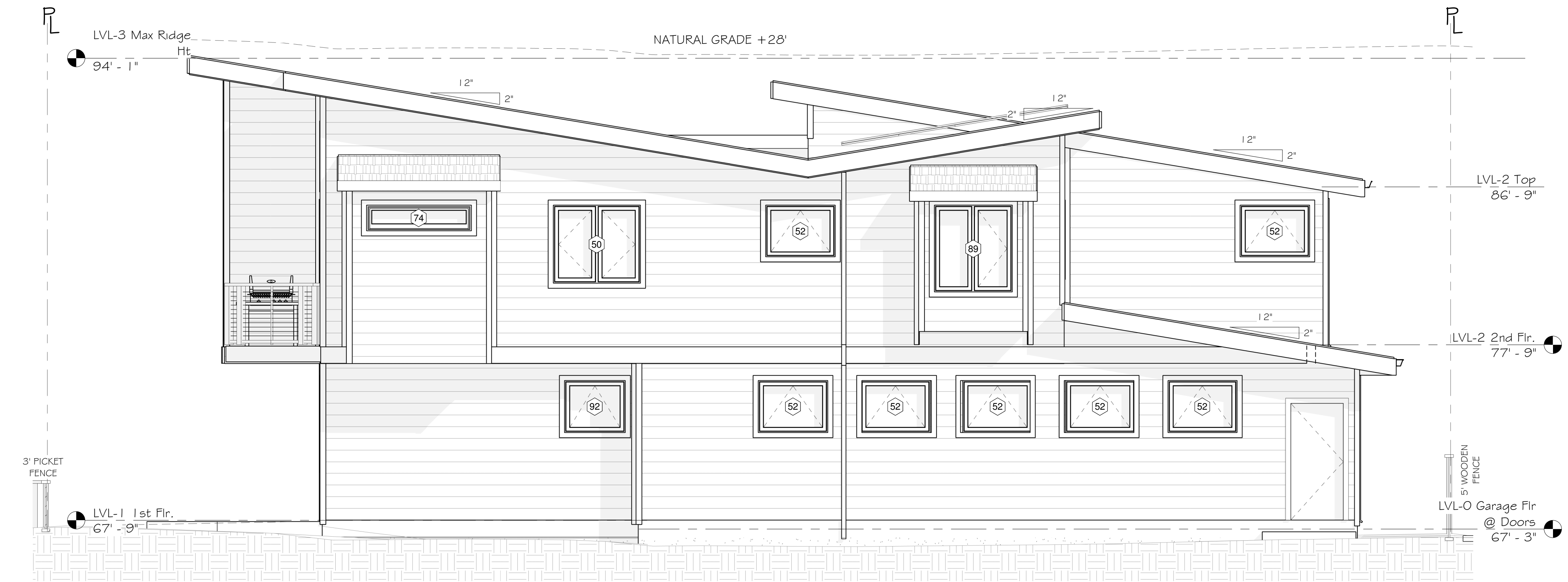

1 CD - East (Rear)
1/4" = 1'-0"

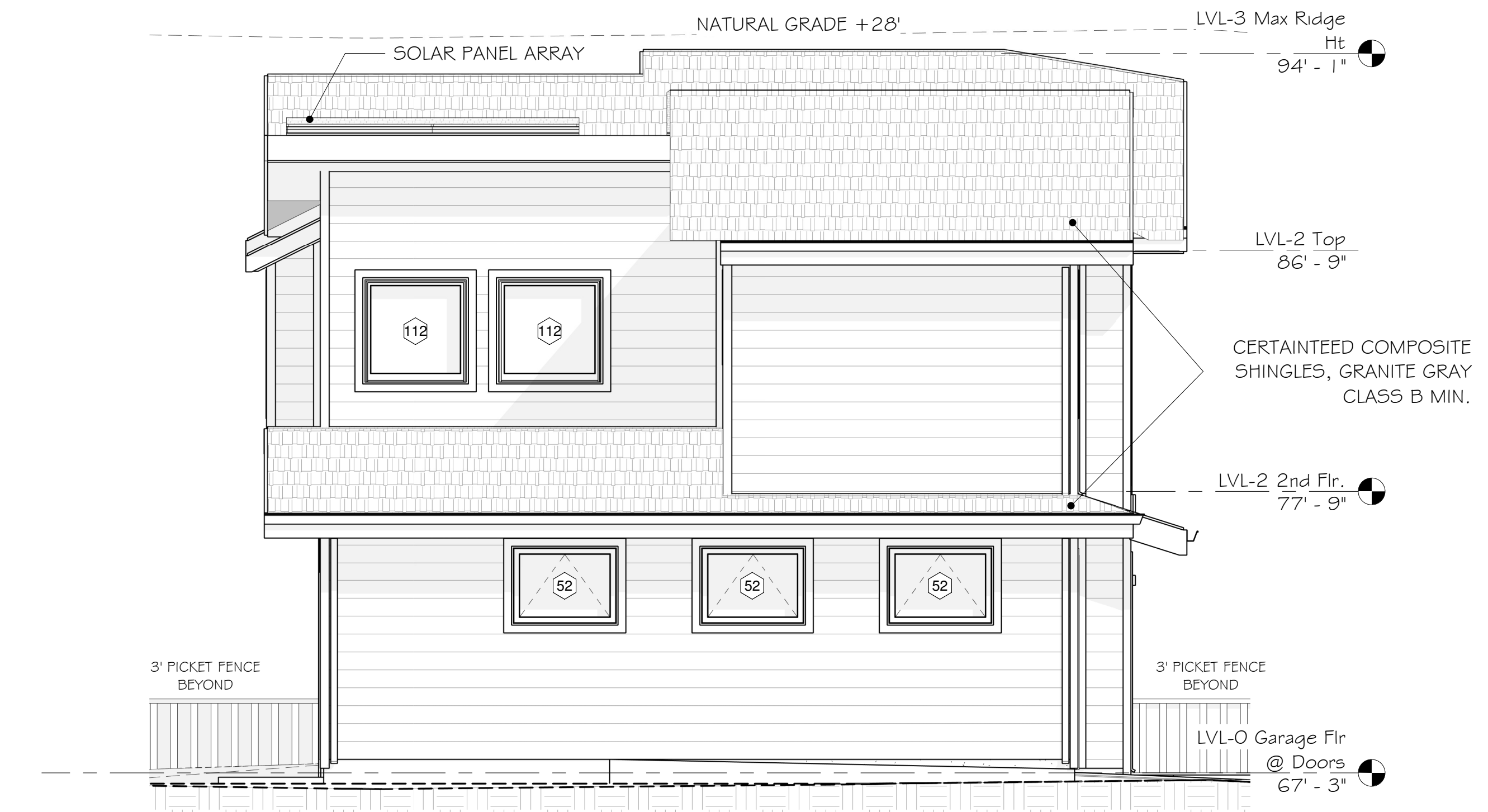

2 CD - North (Left)
1/4" = 1'-0"

S:\Client Projects 2017\Mukaeda\Revit\Mukaeda-V03.rvt

REVISIONS



EDWARD C. LOVE, ARCHITECT

Edward C. Love
Architect
720 MILL STREET
HALF MOON BAY, CA 94019
(650) 728-7615
edwardclovearch@gmail.com

New Residence for
the Mukaeda family
Cypress Ave
Moss Beach, CA

Section Views

FOR
REVIEW
ONLY

DATE: 4/30/2024

SCALE: 1/4" = 1'-0"

DRAWN: GMH

JOB: MUKAEDA

SHEET:

A301

OF SHEETS

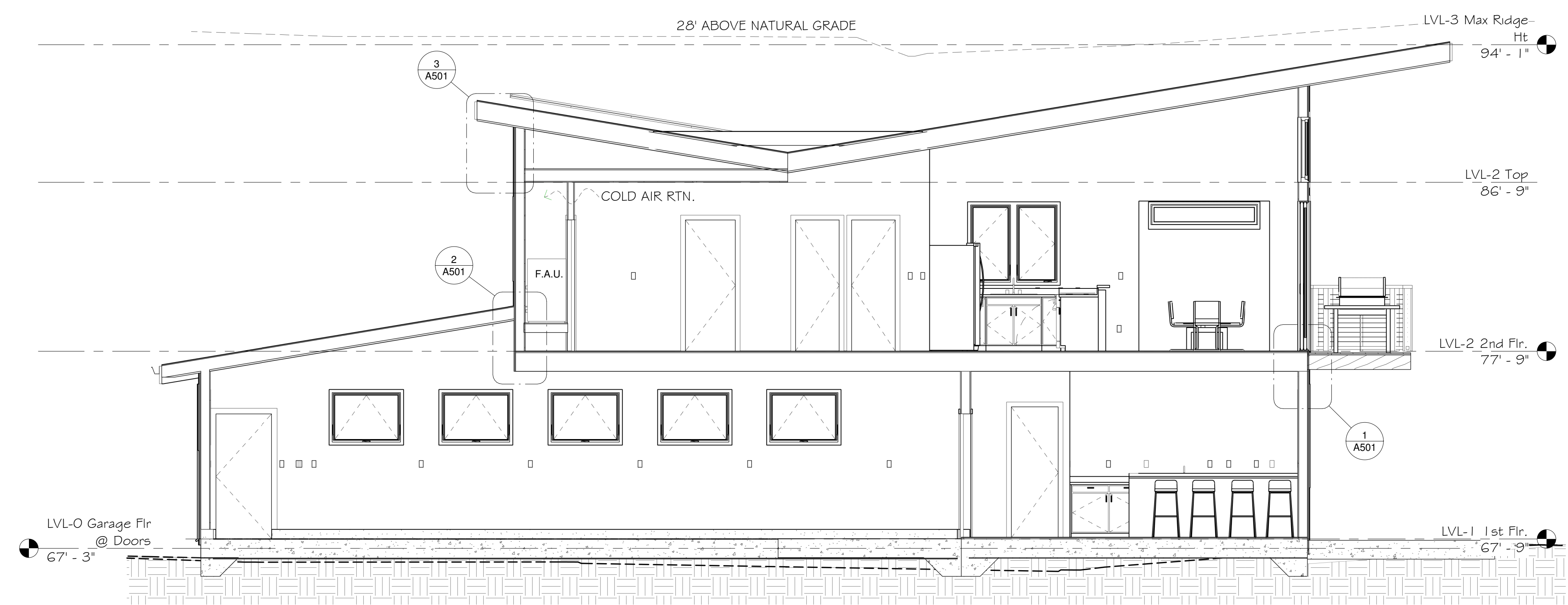

1 CD - Section 02 - EW
1/4" = 1'-0"

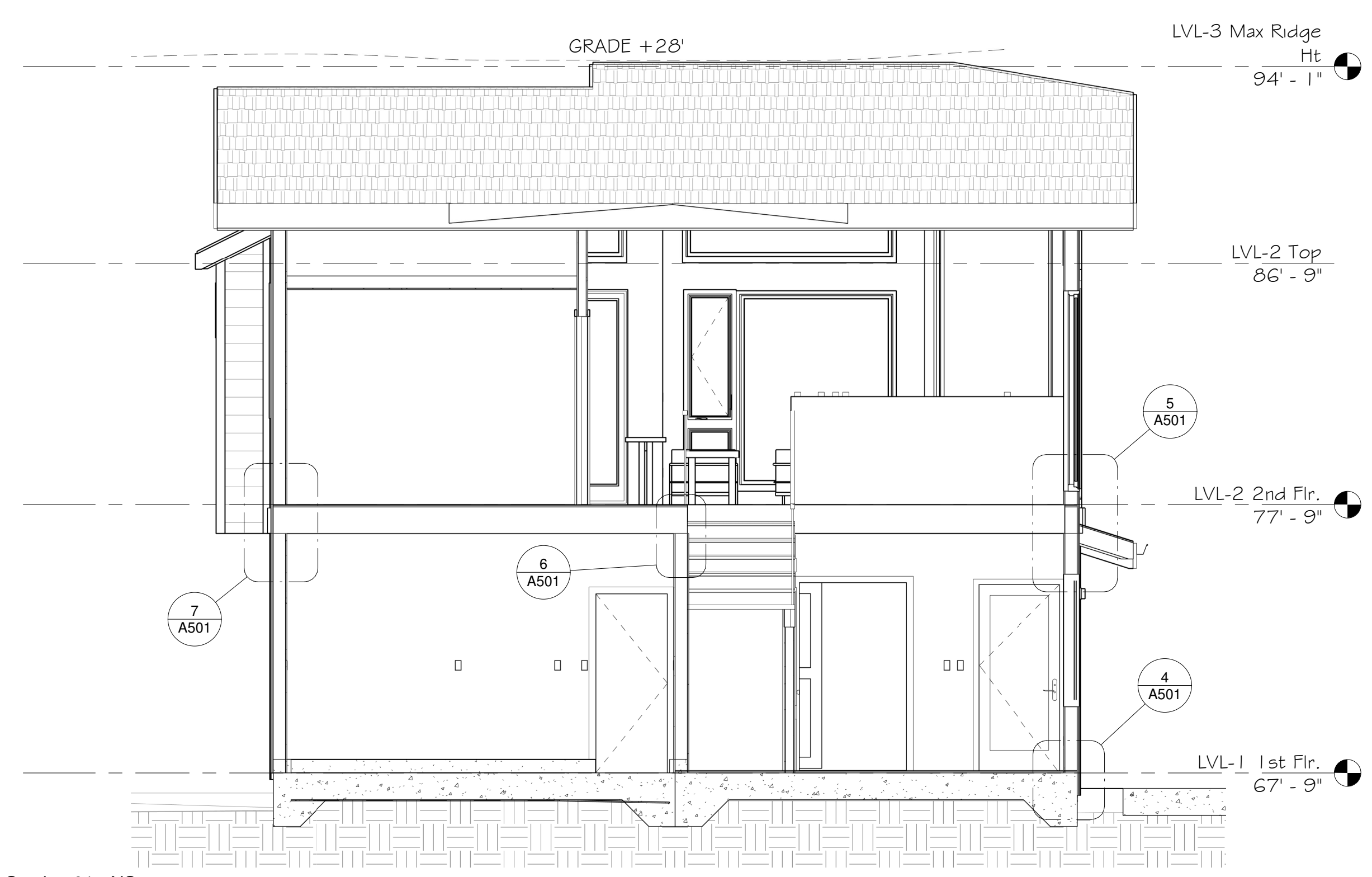

2 CD - Section 01 - NS
1/4" = 1'-0"

S:\Client Projects 2017\Mukaeda\Revit\Mukaeda-V03.rvt

REVISIONS



EDWARD C. LOVE, ARCHITECT

Edward C. Love
Architect
720 MILL STREET
HALF MOON BAY, CA 94019
(650) 728-7615
edwardclovearch@gmail.com

New Residence for
the Mukaeda family
Cypress Ave
Moss Beach, CA

Details

FOR
REVIEW
ONLY

DATE: 4/30/2024

SCALE: 1/2" = 1'-0"

DRAWN: GMH

JOB: MUKAEDA

SHEET:

A501

OF SHEETS

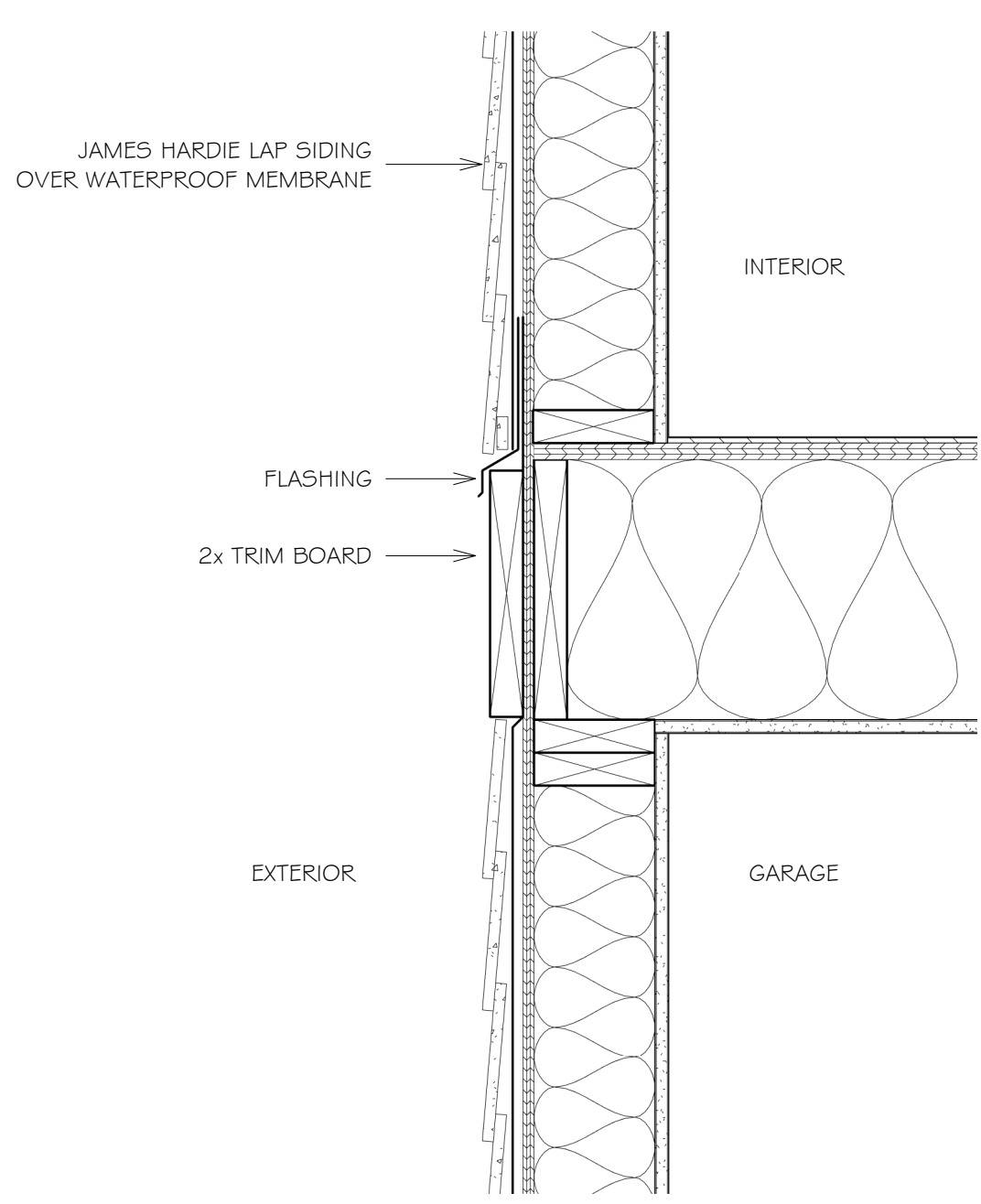

7 Detail - Back Wall
1 1/2" = 1'-0"

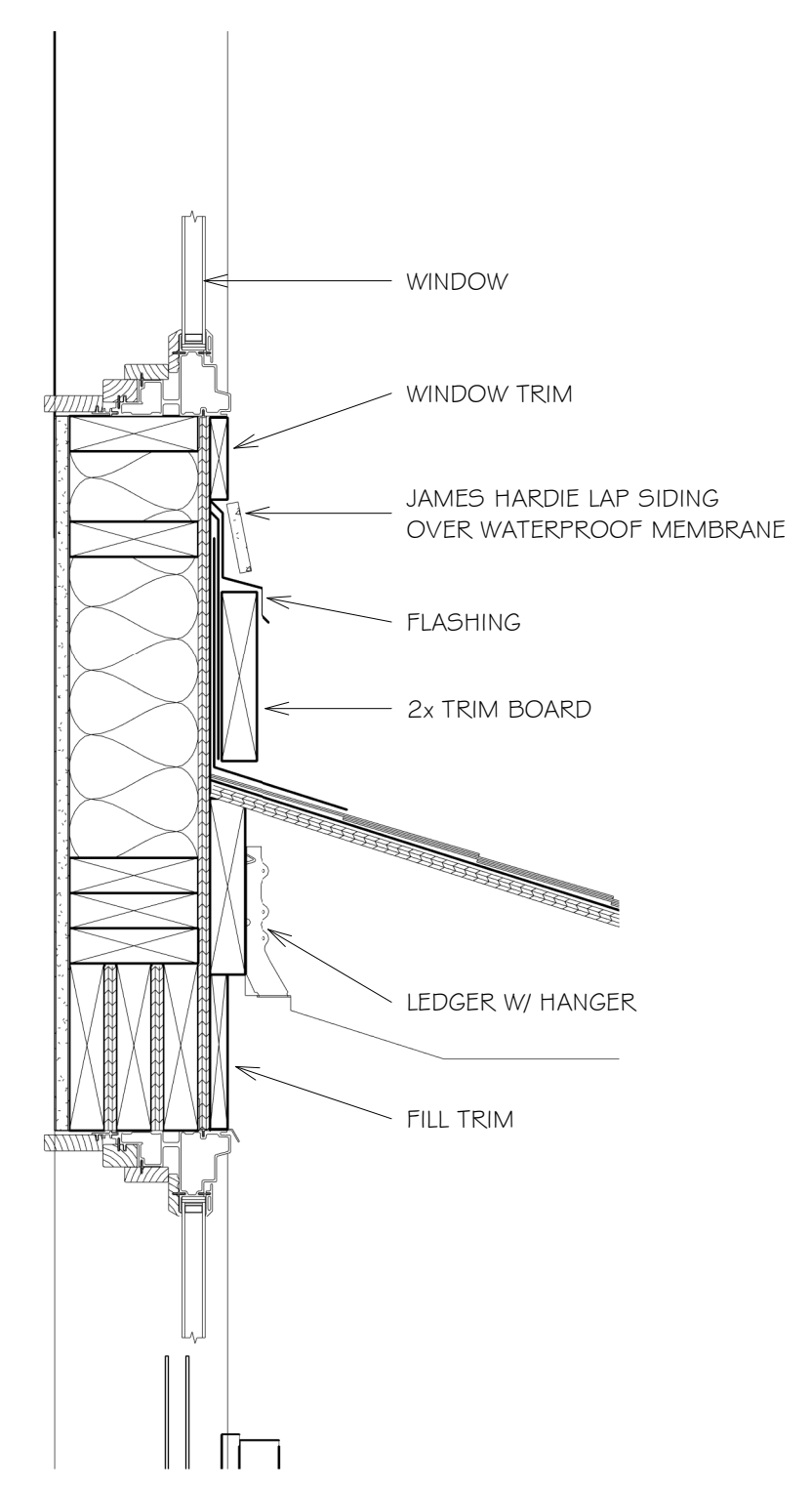

5 Detail - Entry Wall
1 1/2" = 1'-0"

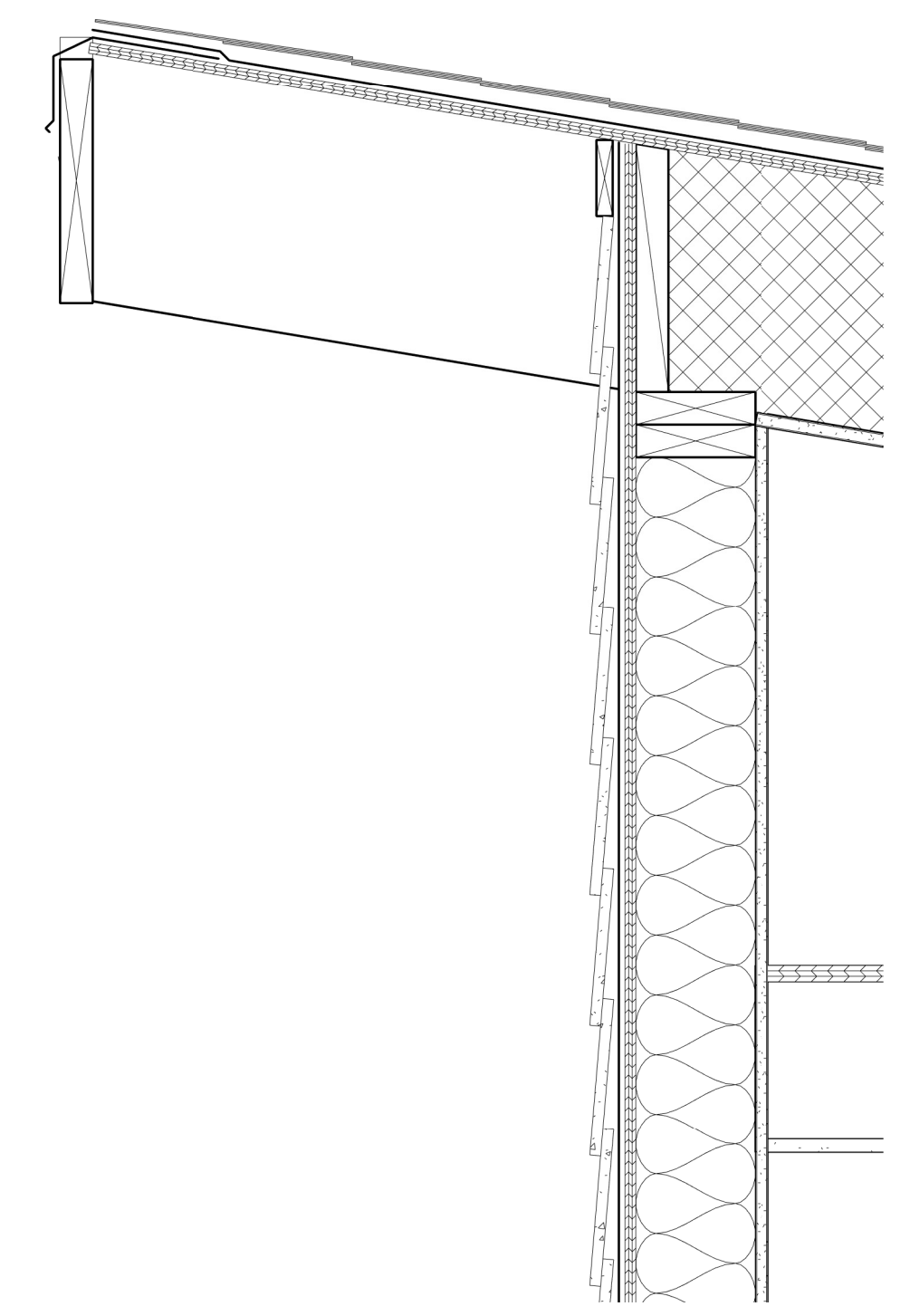

3 Detail - Roof Eave
1 1/2" = 1'-0"

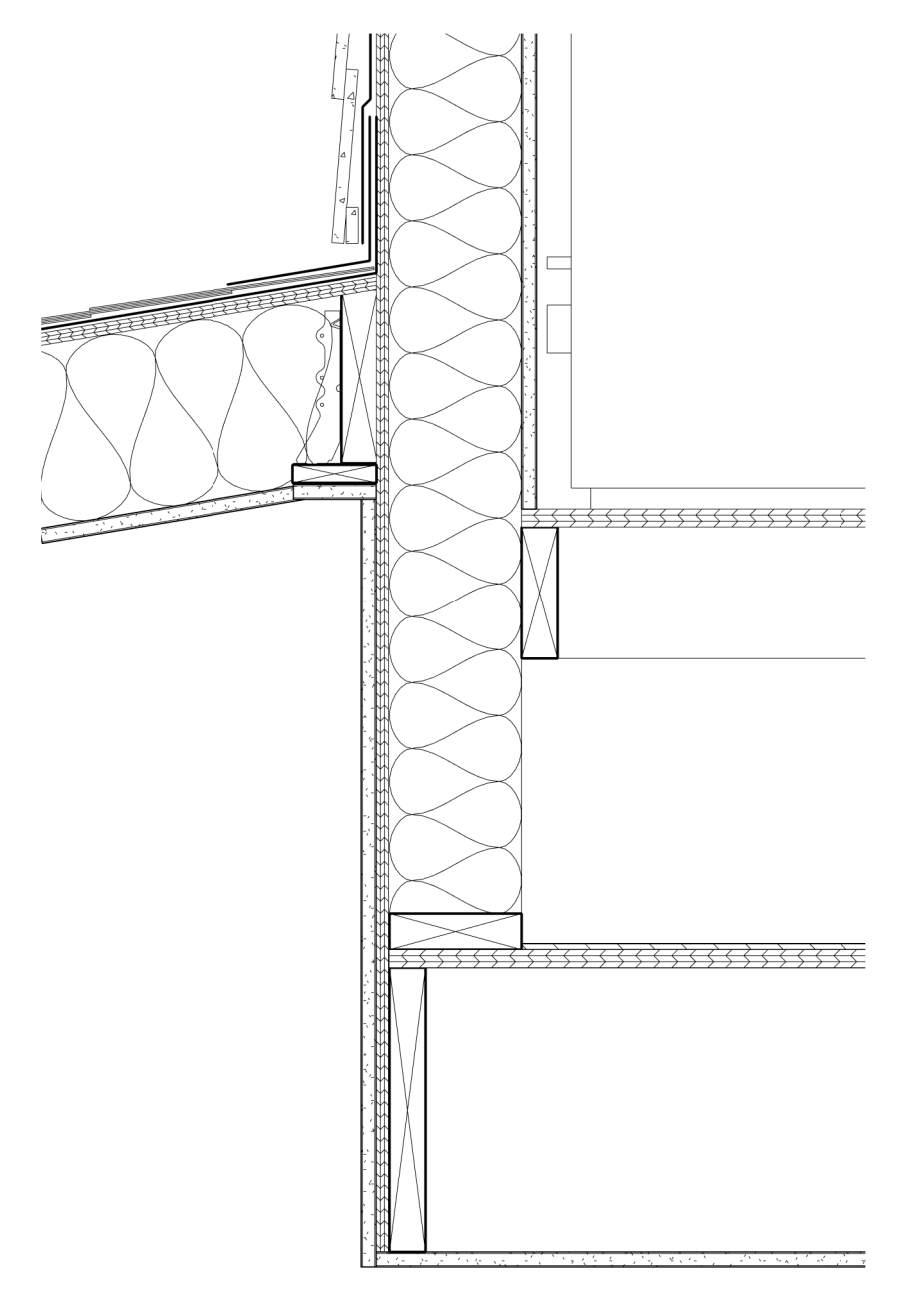

2 Detail - Garage Roof & Ceiling
1 1/2" = 1'-0"

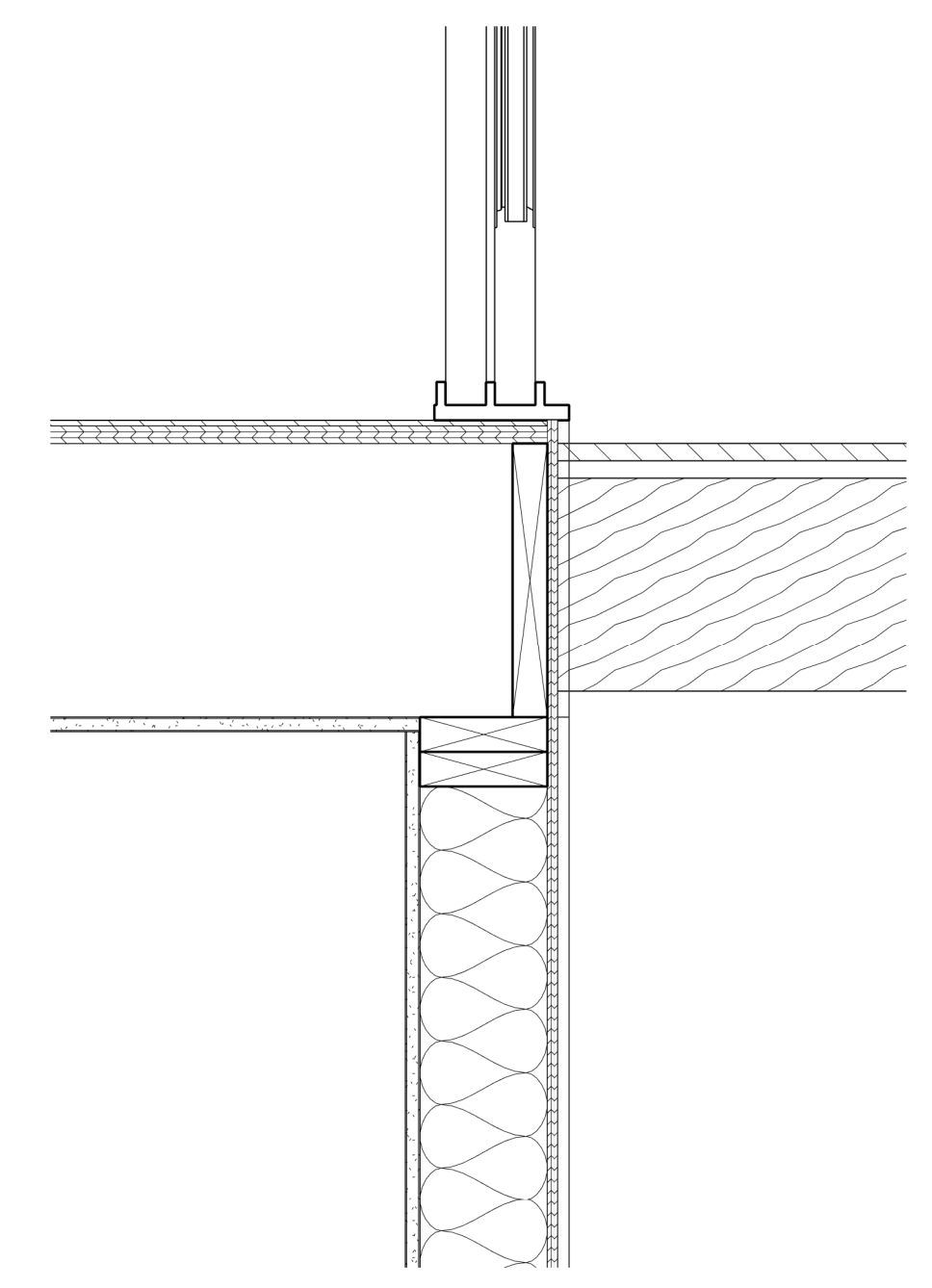

1 Detail - Upstairs Deck
1 1/2" = 1'-0"

SEE STRUCTURAL PLANS FOR MATERIALS,
DIMENSIONS & DETAILS

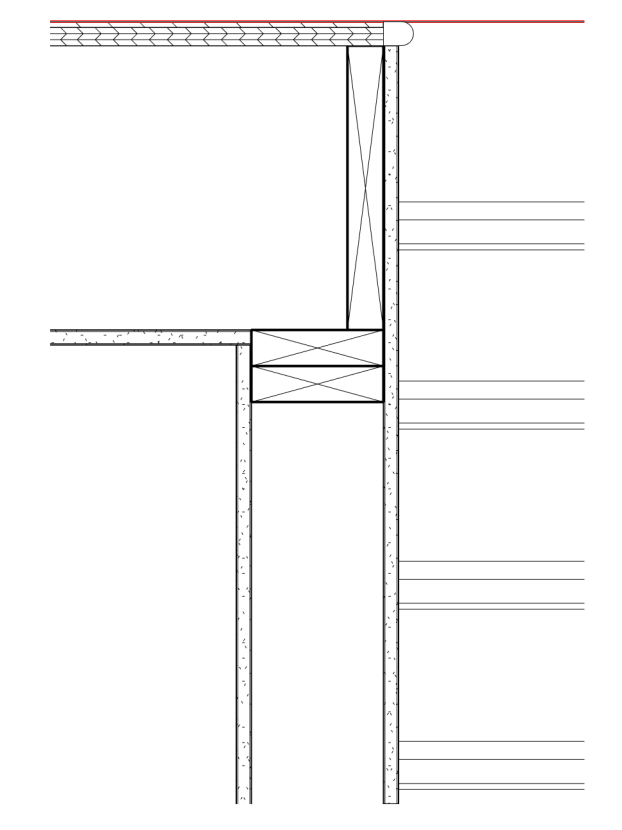

6 Detail - Stairwell & Garage
1 1/2" = 1'-0"

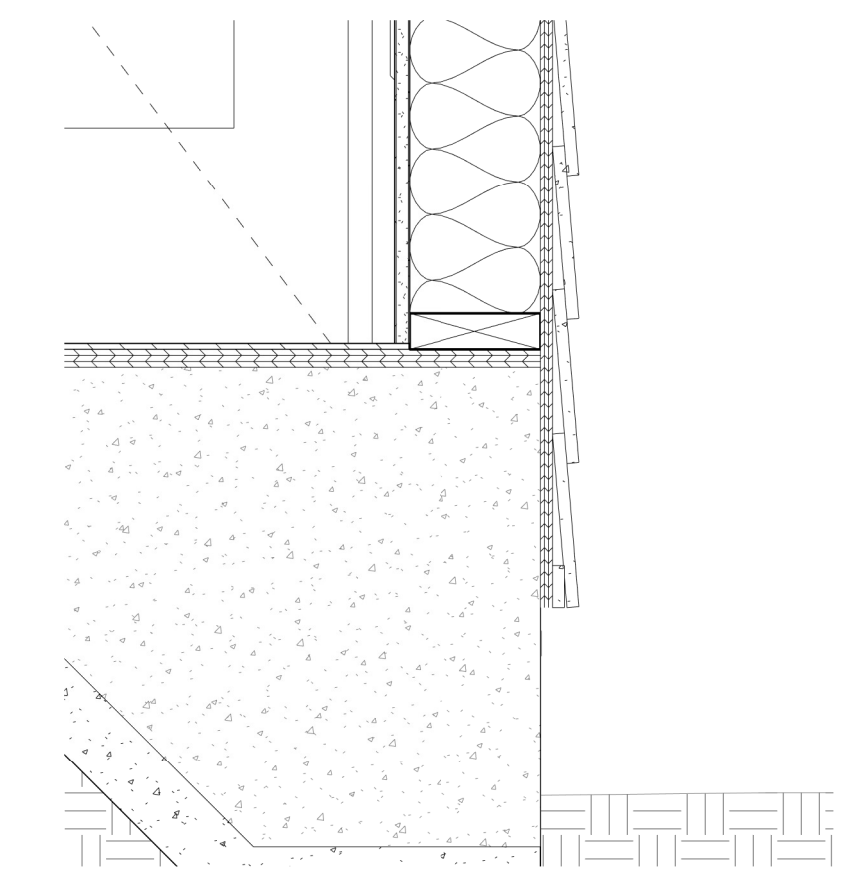

4 Detail - Entry Wall @ Floor
1 1/2" = 1'-0"

S:\Client Projects 2017\Mukaeda\Revit\Mukaeda-V03.rvt

Wayne Dalton GARAGE DOORS
MODEL 8850
 Central and East Region Availability



CONTEMPORARY ALUMINUM

Black powder coated aluminum, White Laminated glass

DOOR FEATURES

- Tongue-and-groove joints provide a great weather barrier
- Flexible vinyl bottom seal helps prevent dirt and elements from entering your garage
- Designed to be easy to maintain
- Constructed with rugged, anodized aluminum frame with equal panel spacing
- Reinforcing fins along with heavy-duty track and brackets help provide years of smooth, trouble-free operation
- The fins are the structural part of the door section that are not visible through the glass
- Choose a 25,000 high cycle spring for almost twice the life of a standard torsion spring

R-VALUES OF INSULATED 8850	987 DOOR	1247 DOOR	988 DOOR	1248 DOOR
1/2" insulated glass Solar Ban 70XL argon filled (R=3.22)	4.06	4.05	3.97	3.96
1/2" insulated glass (R=1.75) with polyurethane filled rails and stiles	2.87	2.86	2.76	2.74
1/2" insulated glass Low E (R=1.38) with polyurethane filled rails and stiles	3.42	3.40	3.31	3.30



Model 8850 offers a one-year limited warranty on the aluminum and one-year limited warranty on the glass. See full text of warranty for details.

*Wayne Dalton uses a calculated door section R-value for our insulated doors.

3 Choose your Glass

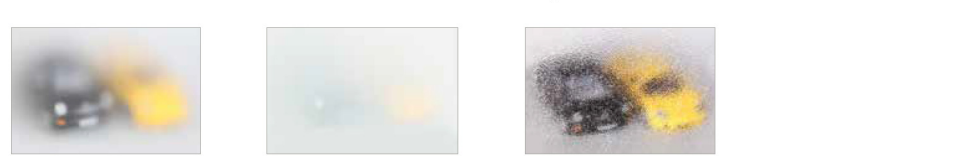

Most panel styles are also available in both single pane and insulated configurations.



Bronze anodized aluminum, Satin Etched glass

1 Select the Platform

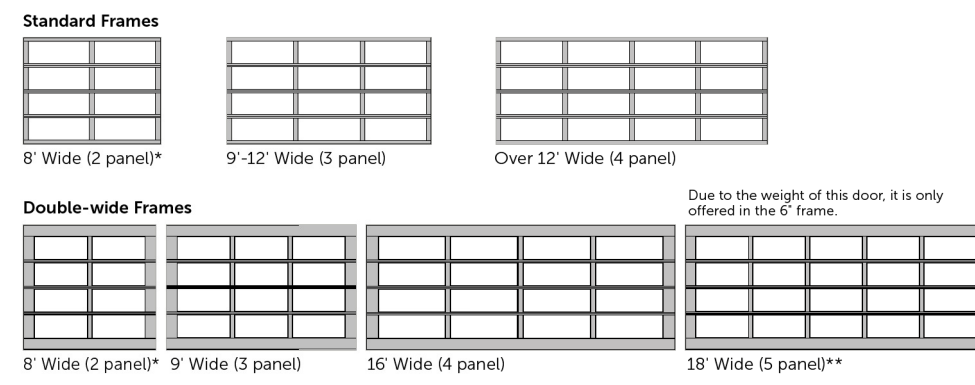

Panel spacing drawings shown are for illustrative purposes only and do not reflect actual stile and rail dimensions. 8" double wide rails and double end stiles apply only to larger doors and not available as options for smaller single doors. *2 panel wide is optional for 9' doors. **Due to the weight of the 18' wide 5 panel door, it is only offered in an 8' frame.

2 Choose your Color

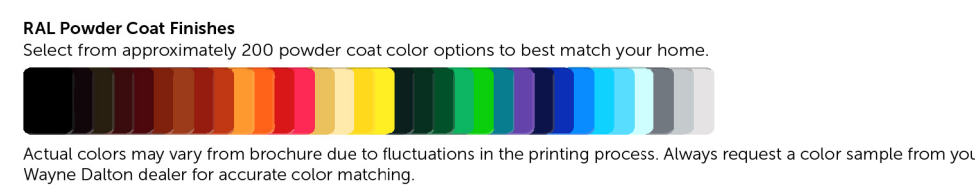
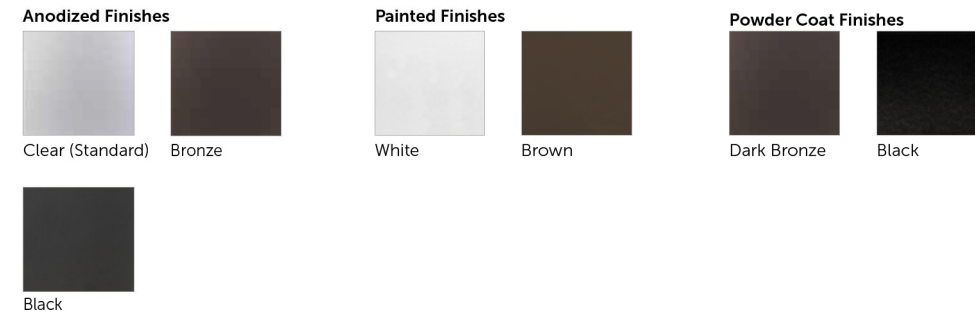

Actual colors may vary from brochure due to fluctuations in the printing process. Always request a color sample from your Wayne Dalton dealer for accurate color matching.



Product Overview

The outdoor LED wall lantern is uniquely designed with a contemporary feel. Its durable aluminum construction with hand painted black finish and frosted glass gives a sophisticated look.

This uniquely designed fixture is the choice of discriminating yet value conscious homeowners who want to enrich their home.

Darksy certified
 Light color is 3000K (bright white)
 360 Lumens
 80 CRI and uses only 5.5-Watt

Specifications

Dimensions		Product Height (in.)	8.01
Product Depth (in.)	5.91	Product Width (in.)	4.49
Product Length (in.)	8.01		
Details		Actual Color Temperature (K)	3000
		Color Rendering Index	80
Exterior Lighting		Product Type	Cylinder Lights
Fixture Material	Aluminum	Fixture Color/Finish	Black
		Glass/Lens Type	Frosted
Light Bulb Type Included	Integrated LED	Light Output (lumens)	360
Maximum Wattage (watts)	0	Number of Bulbs Required	0
Watt Equivalence	60		
Outdoor Lighting Features		Dark Sky, Weather Resistant, Weather Resistant	
Power Type	Hardwired		
Product Weight (lb.)	2.29lb		
Style	Modern		

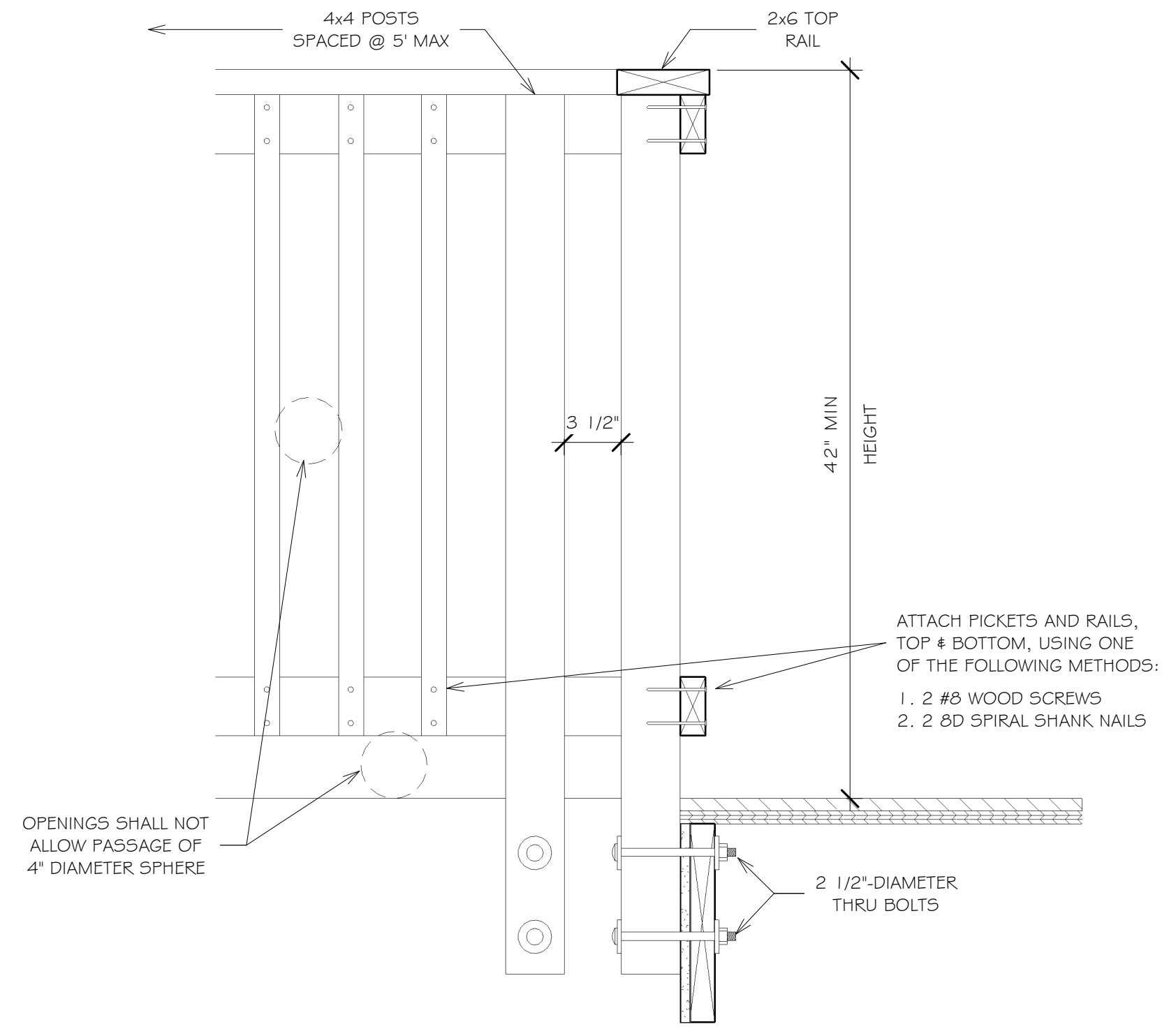

1 Drafting - Handrail
 1 1/2" = 1'-0"

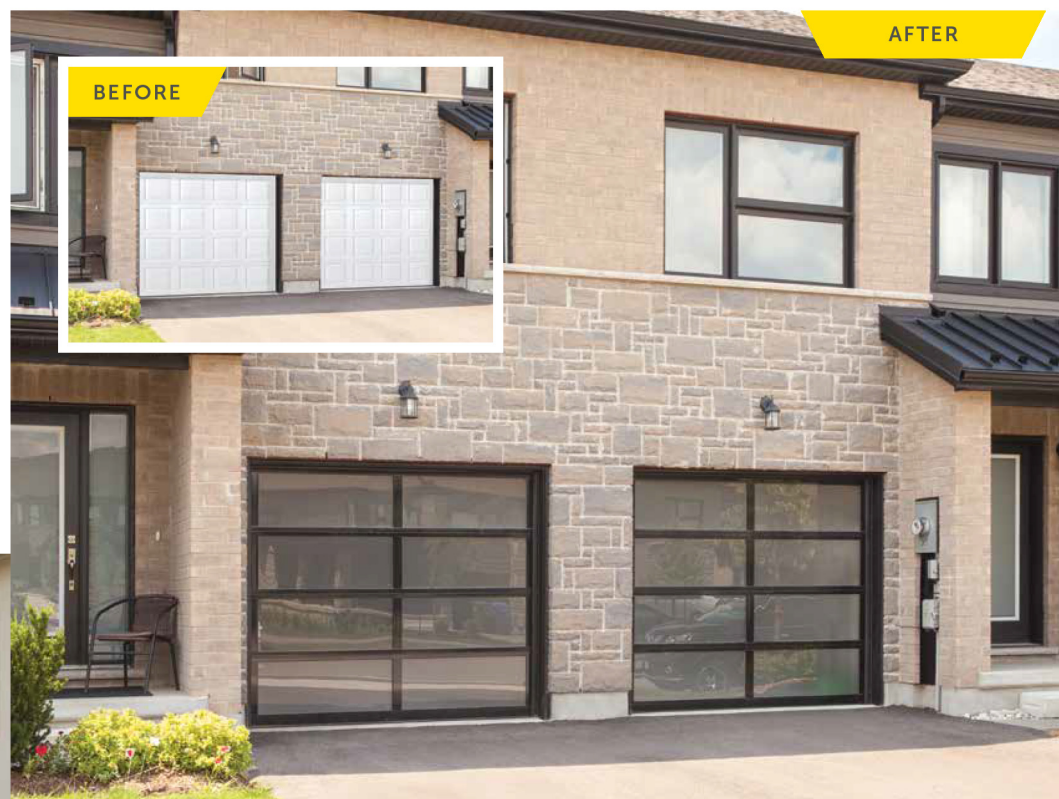

Black powder coat, Satin Etched glass

Garage Door Design Center

To see this door on your home, visit wayne-dalton.com, or download our app, and try our Garage Door Design Center. Upload a photo of your home and experiment with panel designs, color options, window styles and decorative hardware designs. Instant curb appeal awaits you with just a click of your mouse.

Wayne Dalton GARAGE DOORS

2503 S. State Hwy. 123 Box, Ste 200
 Lewisville, TX 75067
wayne-dalton.com

DISTRIBUTED BY:

© 2012 Wayne Dalton, a Division of Overhead Door Corporation. Consistent with our policy of continuing product improvement, we reserve the right to change product specifications without notice or obligation. Item WDD-220-1012

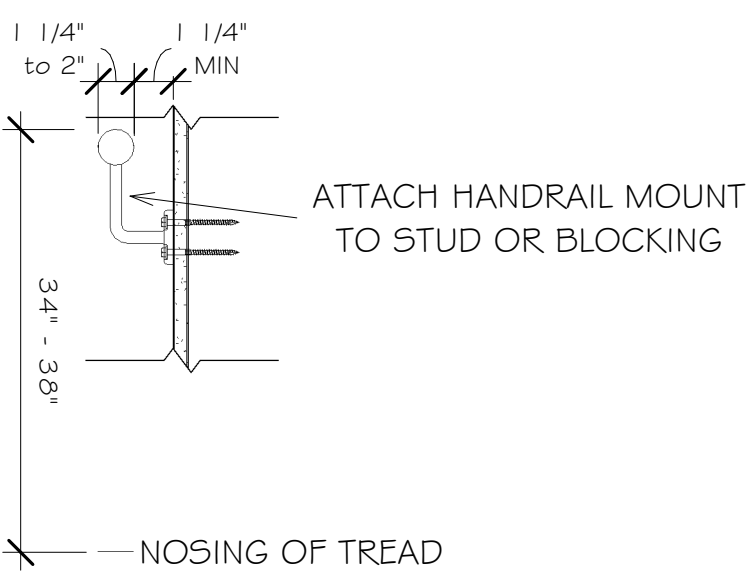

3 Drafting - Stair Handrailing to Wall
 1 1/2" = 1'-0"

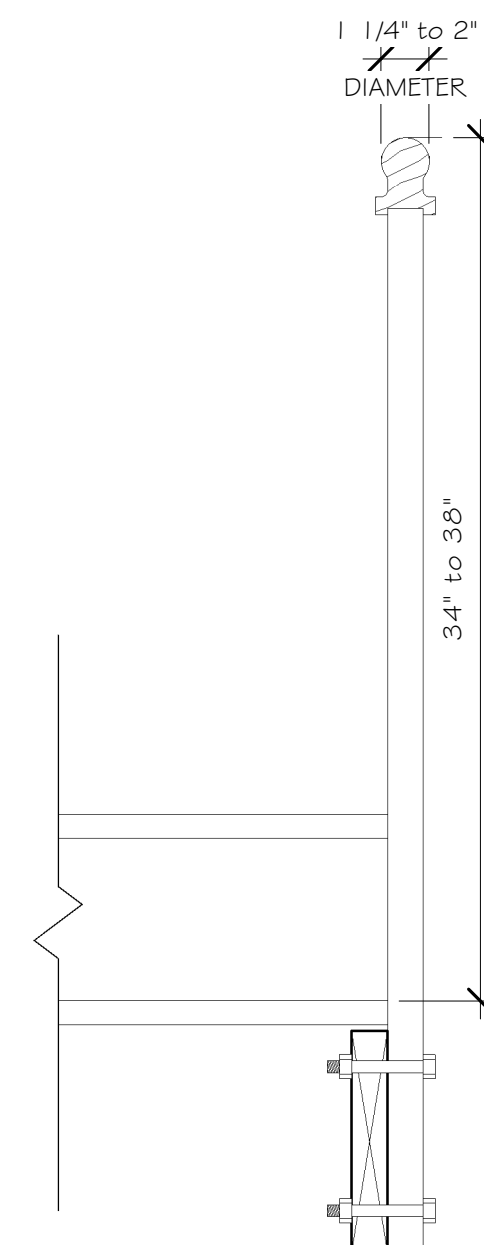

2 Drafting - Stair Mounted Railing
 1 1/2" = 1'-0"

SEE STRUCTURAL PLANS FOR MATERIALS, DIMENSIONS & DETAILS

REVISIONS

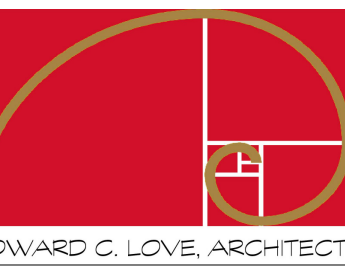

Edward C. Love
 Architect
 720 MILL STREET
 HALF MOON BAY, CA 94019
 (650) 728-7615
edwardclovearch@gmail.com

New Residence for
 the Mukaeda family
 Cypress Ave
 Moss Beach, CA

Details

FOR REVIEW ONLY

DATE: 4/30/2024
 SCALE: 1/2" = 1'-0"
 DRAWN: Author
 JOB: MUKAEDA

SHEET:
A502
 OF SHEETS

S:\Client Projects 2017\Mukaeda\Revit\Mukaeda-V03.rvt

S:\Client Projects\2017\Mukaeda\Revit\Mukaeda-V03.rvt

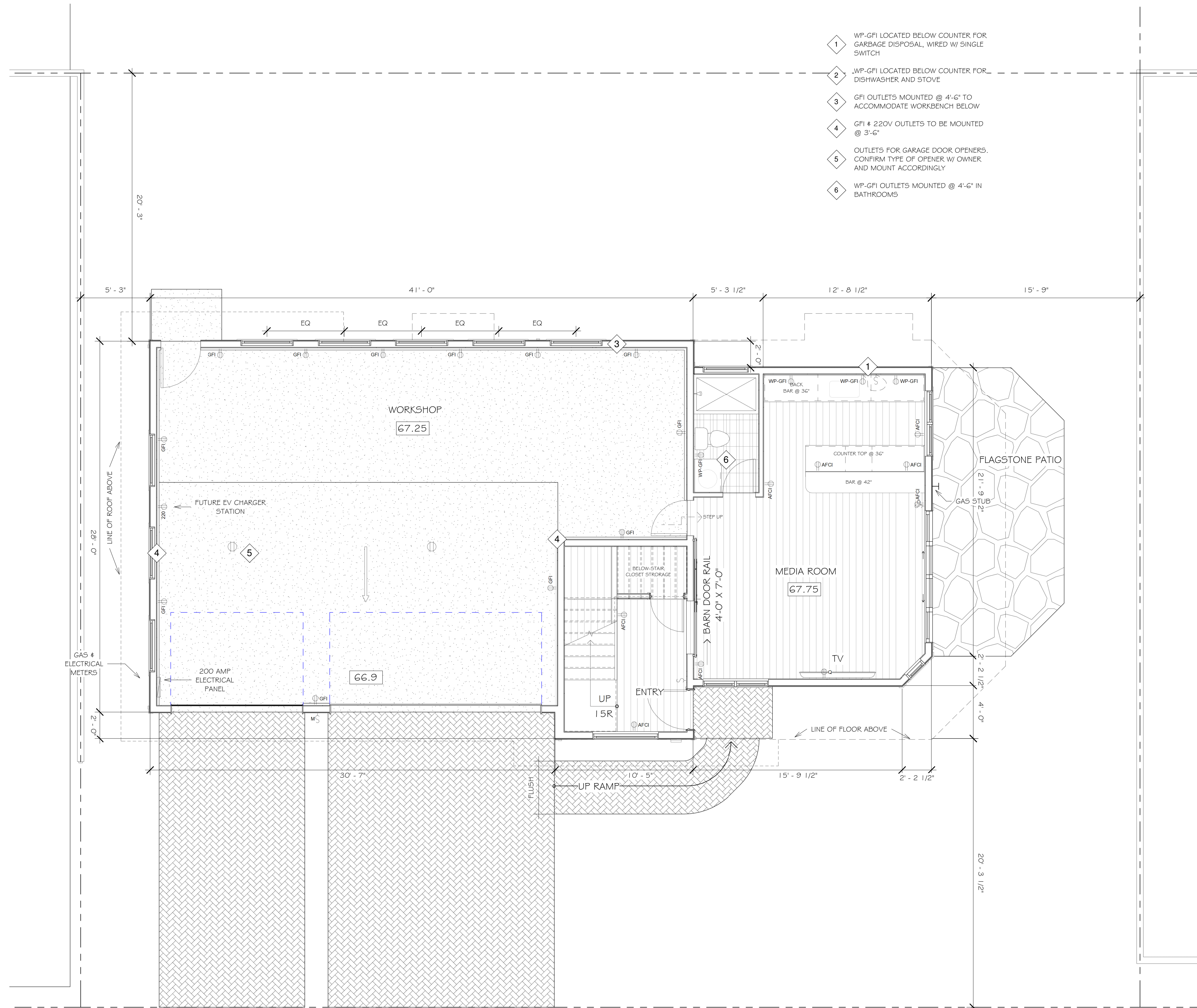

1 First Floor Electrical
1/4" = 1'-0"

- 1 WP-GFI LOCATED BELOW COUNTER FOR GARBAGE DISPOSAL, WIRED W/ SINGLE SWITCH
- 2 WP-GFI LOCATED BELOW COUNTER FOR DISHWASHER AND STOVE
- 3 GFI OUTLETS MOUNTED @ 4'-6" TO ACCOMMODATE WORKBENCH BELOW
- 4 GFI # 220V OUTLETS TO BE MOUNTED @ 3'-6"
- 5 OUTLETS FOR GARAGE DOOR OPENERS. CONFIRM TYPE OF OPENER W/ OWNER AND MOUNT ACCORDINGLY
- 6 WP-GFI OUTLETS MOUNTED @ 4'-6" IN BATHROOMS

- MEP NOTES:**
1. ALL LIGHTING SHALL BE HIGH-EFFICACY (CEC 150(k)1)
 2. ALL OUTDOOR LIGHTING SHALL BE HIGH-EFFICACY AND CONTROLLED BY MOTION SENSOR # PHOTOCONTROL OR OTHER APPROVED METHODS (CEC 150(k)3)
 3. IN BATHROOMS, AT LEAST ONE LIGHT SHALL BE CONTROLLED BY A VACANCY SENSOR (CEC 150.0(k)2j)
 4. 1 25-VOLT, 15 # 20 AMP RECEPTICAL OUTLETS SHALL BE LISTED TAMPER-RESISTANT (CEC 406.11)
 5. ALL BRANCH CIRCUITS THAT SUPPLY 120-VOLT, SINGLE PHASE, 15 # 20 AMP OUTLETS IN DWELLING UNIT KITCHENS, FAMILY ROOMS, DINING ROOMS, LIVING ROOMS, PARLORS, LIBRARIES, DENIS, BEDROOMS, SUNROOMS, RECREATION ROOMS, CLOSETS, HALLWAYS, LAUNDRY AREAS, OR SIMILAR ROOMS OR AREAS SHALL BE ARC-FAULT CIRCUIT INTERRUPTOR (AFCI) PROTECTED (CEC 210.12(A))
 6. A DEDICATED 20 AMP BRANCH CIRCUIT SHALL BE PROVIDED TO SUPPLY BATHROOM RECEPTACLE OUTLETS (CEC 210.11(C)3)
 7. A MINIMUM OF TWO 20 AMP SMALL APPLIANCE CIRCUITS FOR THE KITCHEN COUNTER TOPS SHALL BE PROVIDED. SUCH CIRCUIT SHALL HAVE NO OTHER OUTLETS. LOADS SHALL BE BALANCED (CEC 210.52(B)(2))
 8. PROVIDE 220-VOLT, 30 AMP DEDICATED CIRCUIT FOR DRYER (CEC 220.54)
 9. ALL BATHROOM EXHAUST FANS SHALL BE ENERGY STAR COMPLIANT, DUCTED TO TERMINATE OUTSIDE THE BUILDING AND CONTROLLED BY A HUMIDISTAT CAPABLE OF BEING ADJUSTED BETWEEN THE RELATIVE HUMIDITY RANGE OF 50 TO 80 PERCENT. CGBC 4.506
 10. KITCHEN EXHAUST SHALL BE A MINIMUM OF 100 CFM
 11. WATER CONSERVING FIXTURES # FITTINGS SHALL BE USED IN ACCORDANCE WITH CGBC 4.303. SHALL INCLUDE A MAXIMUM OF 1.28 GPF FOR WATER CLOSETS, MAXIMUM OF 1.8 GPM @ 80 PSI FOR SINGLE SHOWERHEADS. COMBINED FLOW RATE OF MULTIPLE SHOWERHEADS NOT TO EXCEED 1.8 GPM @ 80 PSI, MAXIMUM 1.2 GPM @ 60 PSI FOR LAVATORY FAUCETS, MAXIMUM 1.8 GPM @ 60 PSI FOR KITCHEN FAUCETS.
 12. KITCHEN HOOD EXHAUST FAN SHALL BE DUCTED OUTSIDE IN ACCORDANCE WITH ASHRAE STANDARD 62.2 TABLE 7.1
 13. UFER GROUND OR OTHER APPROVED GROUND PER CEC 250
 14. LISTED RACEWAY PROVIDED TO ACCOMMODATE A DEDICATED 208/240-VOLT BRANCH CIRCUIT. RACEWAY SHALL BE MINIMUM TRADE SIZE 1 AND SHALL ORIGINATE AT THE MAIN SERVICE OR SUBPANEL AND SHALL TERMINATE INTO A LISTED CABINET IN CLOSE PROXIMITY TO THE PROPOSED LOCATION OF THE PROPOSED EV CHARGER. CGBC 4.106.4.1
- WHOLE HOUSE VENTILATION NOTES:**
- ALL BATHROOMS TO BE EQUIPPED WITH WHISPERGREEN SELECT™ ONE FAN - MULTIPLE IAQ SOLUTIONS, 50-80-110 CFM | FV-05-11VK1.
- DUCT SIZE: 4" - 6" (BASED ON CONTRACTOR'S DECISION)
- ASHRAE 62.2 REQUIRED MECHANICAL VENTILATION RATE:
Q_{min} CFM = 84.63
- A LABELSIGN SHALL BE AT CONTROLLER OF SWITCH TO INFORM OCCUPANTS THAT FRESH AIR VENTILATOR IS A WHOLE HOUSE VENTILATION FAN THAT SHOULD OPERATE WHENEVER THE BUILDING IS OCCUPIED.

- ⏏ 220-VOLT OUTLET
- ⏏ AFCI ARC FAULT CIRCUIT INTERRUPT OUTLET
- ⏏ GFI GROUND FAULT INTERRUPT OUTLET
- ⏏ QUAD AFCI OUTLET
- ⏏ WP-GFI WATER-PROOF GFI OUTLET
- ⏏ 220V DRYER OUTLET
- ⊕ CEILING MOUNTED DUPLEX OUTLET



REVISIONS



Edward C. Love
Architect
720 MILL STREET
HALF MOON BAY, CA 94019
(650) 728-7615
edwardclovearch@gmail.com

New Residence for
the Mukaeda family
Cypress Ave
Moss Beach, CA

First Floor Electrical
Plan







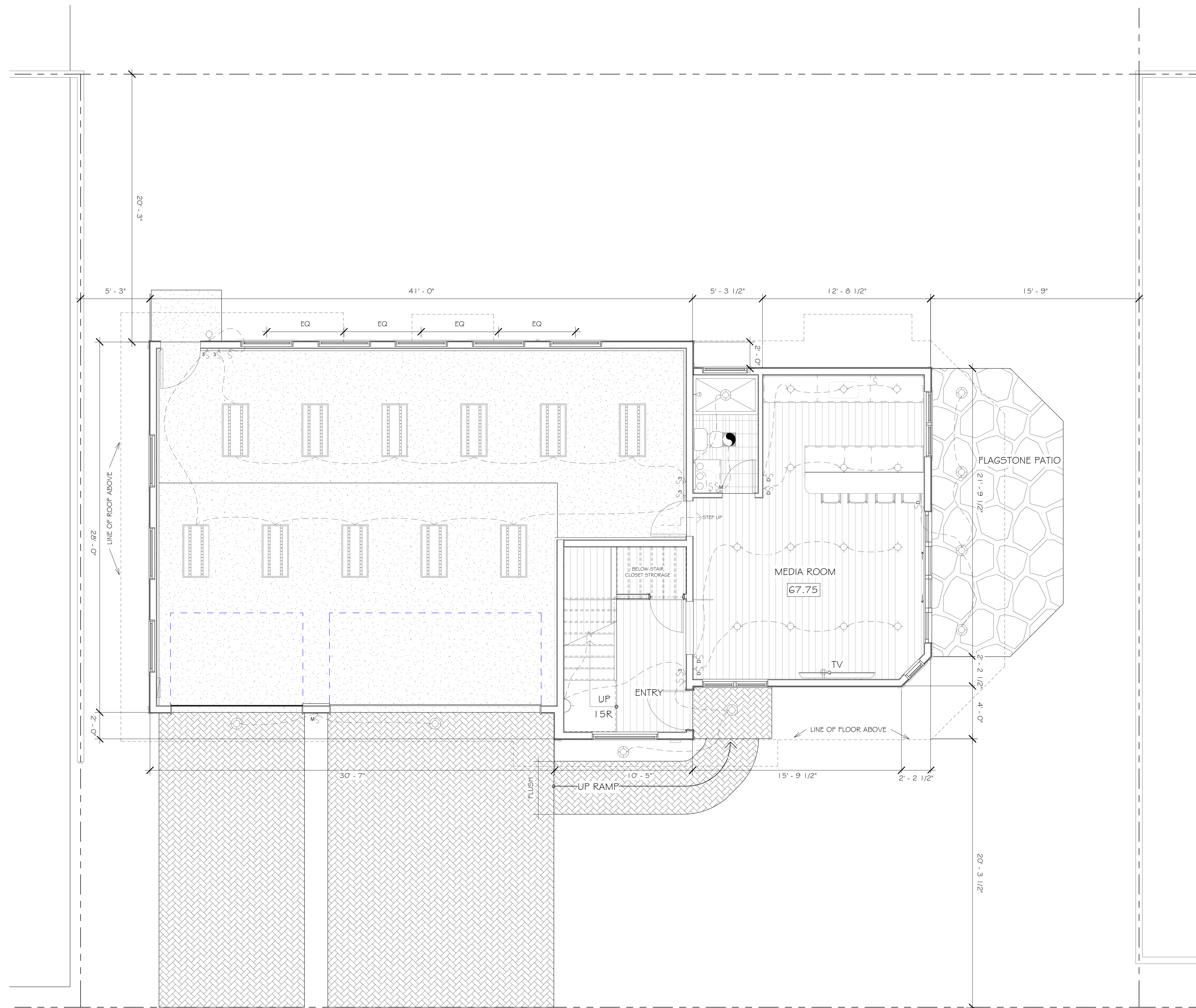



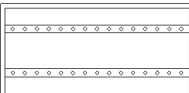

FOR REVIEW ONLY

DATE: 4/30/2024
SCALE: 1/4" = 1'-0"
DRAWN: GMH
JOB: MUKAEDA
SHEET:
E101
OF SHEETS

S:\Client Projects 2017\Mukaeda\Revit\Mukaeda-V03.rvt



1 First Floor Lighting
1/4" = 1'-0"

-  RECESSED BOX LED
-  RECESSED LED
-  RECESSED DIRECTIONAL LED
-  RECESSED WATER-PROOF LED
-  EXTERIOR LIGHT
-  WALL SCONCE
-  VANITY FIXTURE
-  CEILING FAN
-  SINGLE SWITCH
-  DIMMER SWITCH
-  3-WAY DIMMER SWITCH
-  MOTION-TIMER SWITCH
-  THREE-WAY SWITCH



REVISIONS



Edward C. Love
Architect
720 MILL STREET
HALF MOON BAY, CA 94019
(650) 728-7615
edwardclovearch@gmail.com

New Residence for
the Mukaeda family
Cypress Ave
Moss Beach, CA

First Floor Lighting
Plan

FOR
REVIEW
ONLY

DATE: 4/30/2024

SCALE: 1/4" = 1'-0"

DRAWN: GMH

JOB: MUKAEDA

SHEET:

E102





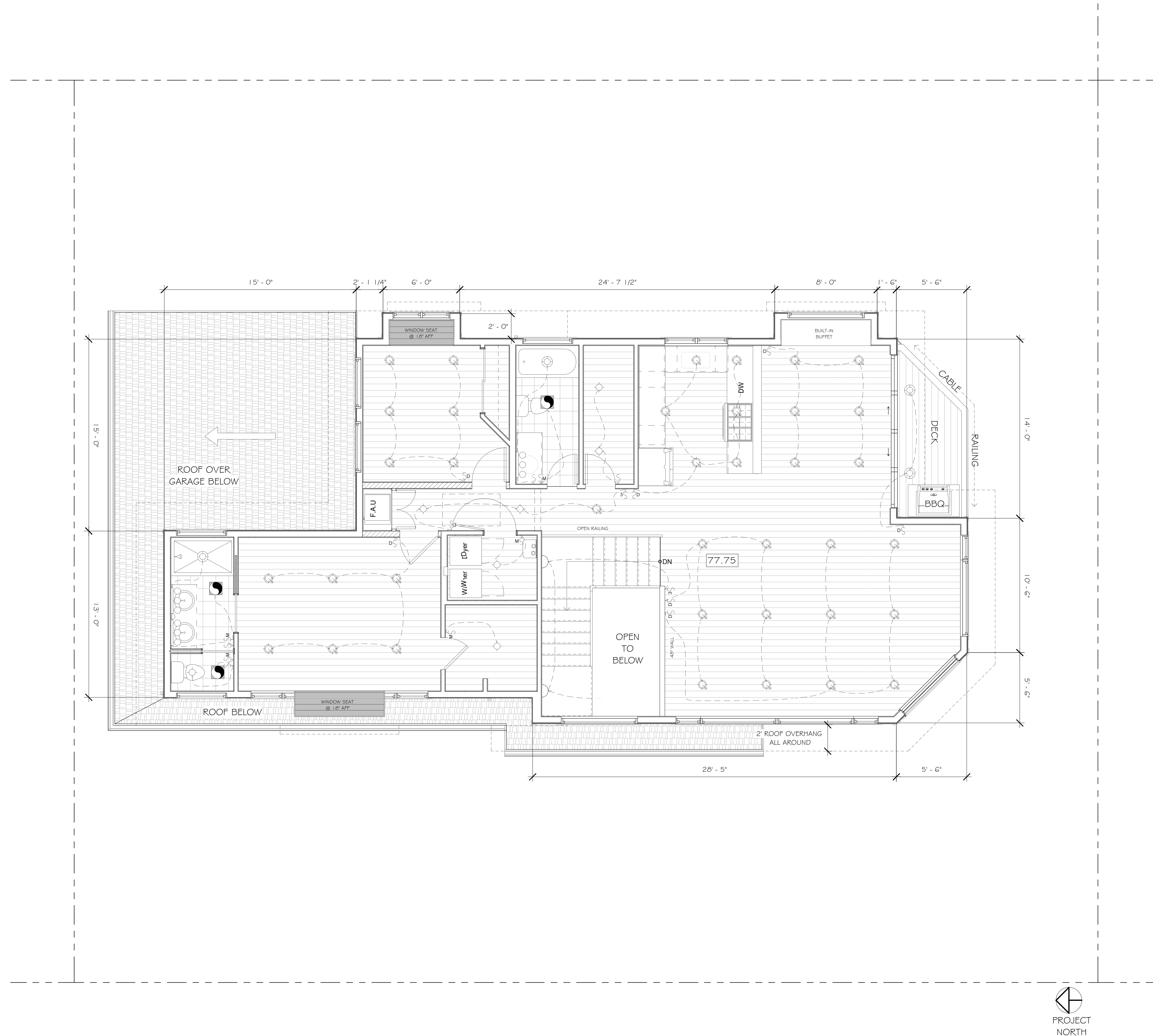





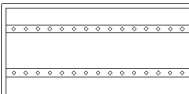

OF SHEETS

S:\Client Projects 2017\Mukaeda\Revit\Mukaeda-V03.rvt



1 Second Floor Lighting
1/4" = 1'-0"



-  RECESSED BOX LED
-  RECESSED LED
-  RECESSED DIRECTIONAL LED
-  RECESSED WATER-PROOF LED
-  EXTERIOR LIGHT
-  WALL SCONCE
-  VANITY FIXTURE
-  CEILING FAN
-  SINGLE SWITCH
-  DIMMER SWITCH
-  3-WAY DIMMER SWITCH
-  MOTION-TIMER SWITCH
-  THREE-WAY SWITCH

REVISIONS



Edward C. Love
Architect
720 MILL STREET
HALF MOON BAY, CA 94019
(650) 728-7615
edwardclovearch@gmail.com

New Residence for
the Mukaeda family
Cypress Ave
Moss Beach, CA

Second Floor Lighting
Plan

FOR
REVIEW
ONLY

DATE: 4/30/2024
SCALE: 1/4" = 1'-0"
DRAWN: ECL
JOB: MUKAEDA

SHEET:
E104

OF SHEETS



① Color Board
1/4" = 1'-0"



HARDIE PLANK LAP SIDING PRIMED
THE STATEMENT COLLECTION



SIDING PAINT COLOR - BEHR -
SLATE GRAY -6695

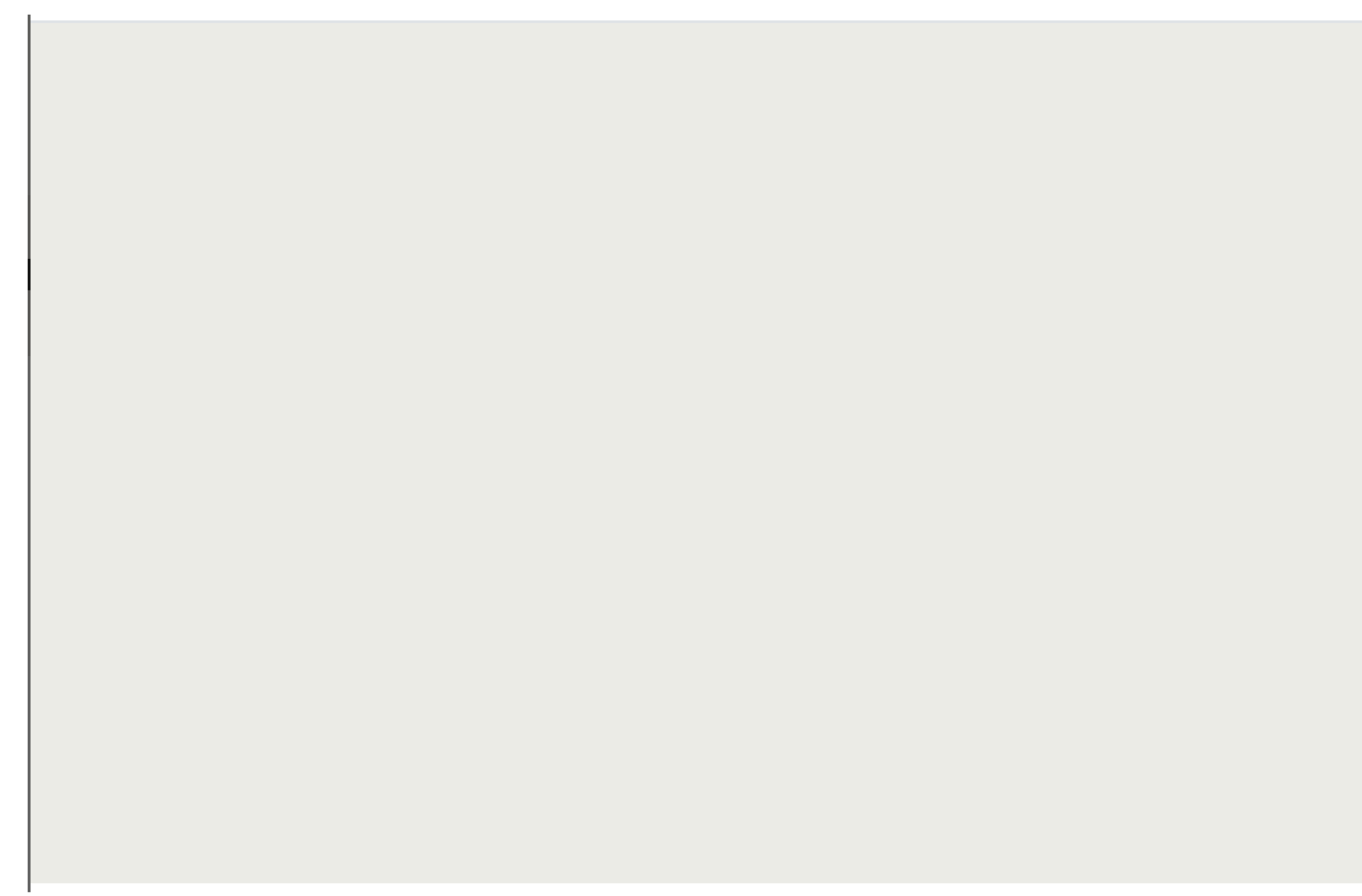

TRIM PAINT COLOR - BEHR -
WHITE - 52

REVISIONS



EDWARD C. LOVE, ARCHITECT

Edward C. Love
Architect
720 MILL STREET
HALF MOON BAY, CA 94019
(650) 728-7615
edwardclovearch@gmail.com

New Residence for
the Mukaeda family
Cypress Ave
Moss Beach, CA

Color Board

FOR
REVIEW
ONLY

DATE: 4/30/2024

SCALE: 1/4" = 1'-0"

DRAWN: Author

JOB: MUKAEDA

SHEET:

A503

OF SHEETS

Key	Botanical Name	Common Name	Light Needs	Avg. Plant Size	WUCOLS	Plant Type	Origin
	<i>Leymus condensatus</i> 'Canyon Prince'	Canyon Prince wild rye	Sun-Part Shade	6'h x 4'w	Low	Grass	Ca. Native
	<i>Agave</i> 'Blue Flame'	Blue Agave	Sun	3'h x 3'w	Low	Per. Shrub	Hybrid (Ca.N)
	<i>Dudleya lanceolata</i>	Dudleya	Sun-Part Shade	6"h x 6"w	Low	Per. Succulent	Ca. Native
	<i>Eschscholzia californica</i>	California poppy	Sun	1'h x 1'w	Very Low	Perennial	Ca. Native
	<i>Carex pansa</i>	Sand dune Sedge	Sun-Part Shade	1'h x spreads w	Moderate	Perennial	Ca. Native
	<i>Thunbergia gregorii</i>	Orange clock vine	Sun-Part Shade	8'h	Moderate	Vine	Africa
	<i>Dichondra occidentalis</i>	Western Dichondra	Sun-Part Shade	4"h x spreads w	Low	Perennial	Ca. Native
	<i>Sedum spurium</i> 'Dragon's Blood'	Dragon's Blood Stonecrop	Sun-Part Shade	6"h X 2'w	Low	Groundcover	Europe
	Mulch						

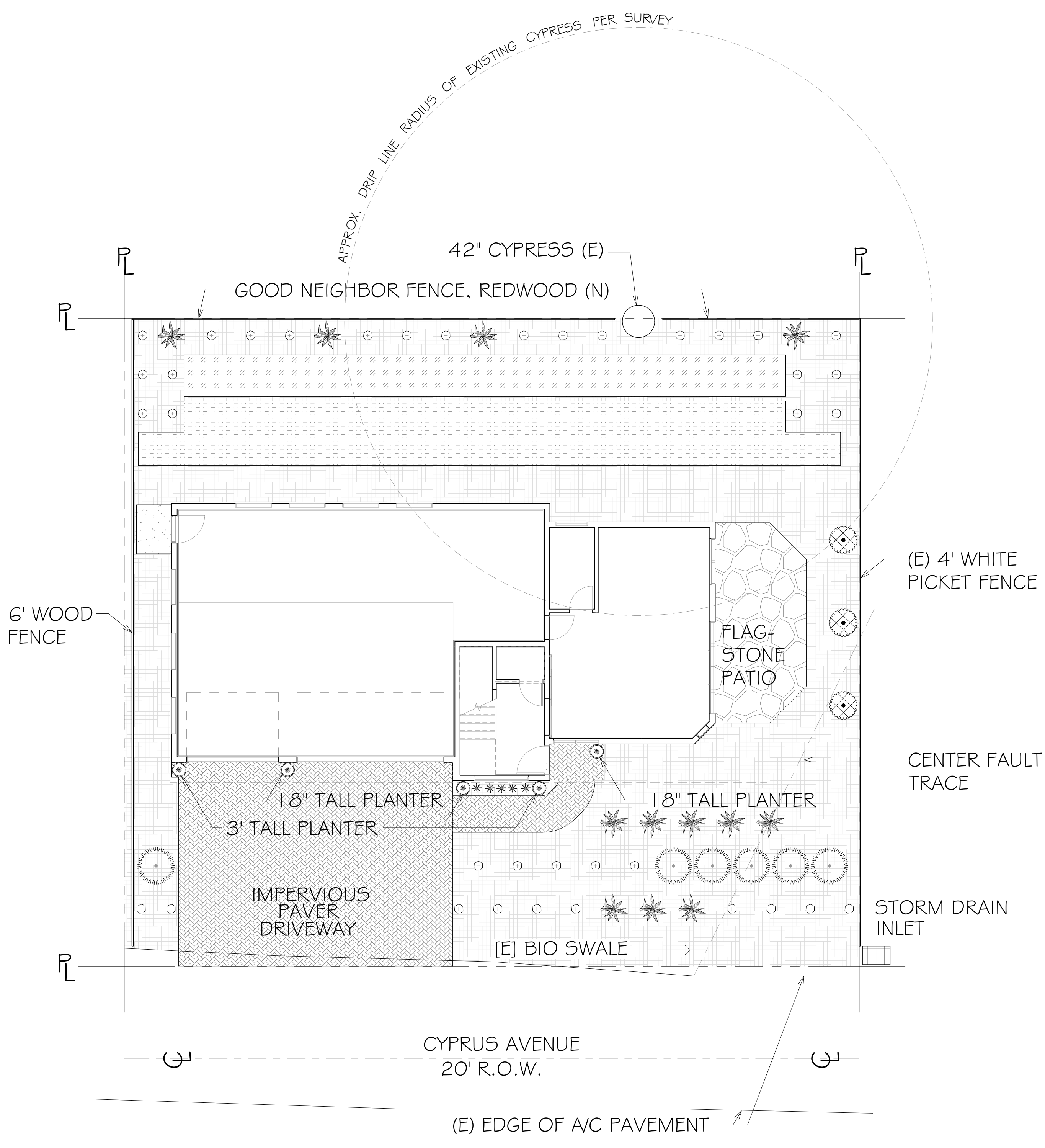

Leymus condensatus 'Canyon Prince' *Agave* 'Blue Flame' *Dudleya lanceolata* *Eschscholzia californica* *Carex pansa*



Thunbergia gregorii *Dichondra occidentalis* *Sedum spurium* 'Dragon's Blood'

PLANTING NOTES

- Contractor to provide a soils test and amend soils per recommendation. For bid purposes amend soil as follows to a 6" depth:
6 cy per ksf Organic compost
10# per ksf Fertilizer
- Contractor to apply a 3" layer of mulch on all exposed soil surfaces of planting areas, except in areas of turf or creeping or rooting groundcovers.
- Landscape shall comply with all County of San Mateo requirements.

LANDSCAPE AREAS (APPROXIMATE)

1,255 SF	Hardscape
650 SF	Vegetation (WUCOL: moderate)
1,209 SF	Vegetation (WUCOL: low - very low)
1,200 SF	Mulch Only

SEE GRADING & DRAINAGE PLAN C-1



Mukaeda Residence
Cypress Ave
Moss Beach, CA

Date:
07/20/18

Scale: 1/8" = 1'

Landscape & Planting Concept

Sheet:
L1