

July 22, 2019

Kerry Burke
PO Box 779
Half Moon Bay, CA 94019

Dear Ms. Burke:

SUBJECT: Coastside Design Review Continuance
Hermosa Avenue, Miramar
APN 048-065-190; County File No. PLN 2019-00060

At its meeting of July 11, 2019, the San Mateo County Coastside Design Review Committee (CDRC) considered your application for a Design Review Permit to allow construction of a new two-story 2,675 sq. ft. single-family residence, plus a 429 sq. ft. attached two-car garage, and a 650 sq. ft. Accessory Dwelling Unit (ADU) on a 20,012 sq. ft. legal parcel (per Lot Line Adjustment: LLA92-0016). The property would be accessed via a 100-foot long new driveway from an existing improved portion of Hermosa Avenue. No significant tree removal and only minor grading is proposed. The project scope includes the removal of a portion of an arroyo willow thicket to accommodate the proposed development. The ADU is a ministerial project that does not require review by the CDRC. This project qualifies for a Coastal Development Permit Exemption and is not appealable to the California Coastal Commission.

The CDRC was unable to make the findings for a design review approval based on certain design deficiencies. In order to resolve these deficiencies in the project's design, a more thorough review of the Local Coastal Program and "Standards for Design for One-Family and Two-Family Residential Development in the Midcoast" manual is required. As such, requirements from the CDRC for further project redesign are as follows:

1. Recommendations Discussed Include:
 - a. Reposition the primary residence to match the plans reviewed at the June 13, 2019 CDRC meeting (10 feet between the primary residence and garage).
 - b. Provide a color scheme with actual material and paint samples for all siding and roof materials.
 - c. Provide a rendering of the project as seen from Alto Avenue with reduced vegetation as proposed for accurate project visibility. Renderings are to be posted 10 calendar days prior to the date of the CDRC meeting on which this project will be reviewed.



As such, you were presented with the following available options at the end of the CDRC's deliberation of the project: (i) request for a decision from the CDRC on the plans presented or (ii) request that the project be considered at the next meeting to provide you with ample time to consider and incorporate the elements recommended for project redesign. You chose the second option, and the CDRC directed staff to schedule your project for consideration at a later date.

Please contact Ruemel Panglao, Project Planner, at 650/363-4825 or rpanglao@smcgov.org, if you have any questions.

To provide feedback, please visit the Department's Customer Survey at the following link: <http://planning.smcgov.org/survey>.

Sincerely,



Dennis P. Aguirre
Design Review Officer

DPA:RSP:cmc – RSPDD0360_WCN.DOCX

cc: Randy Ralston and Linda Mendiola, Owners
Bruce Chan, Member Landscape Architect
Kayleen Kostuik, Member Architect
Linda Montalto Patterson, Miramar Community Representative
Kerry Burke, Applicant
Erik Martinez, California Coastal Commission
Lennie Roberts, Committee for Green Foothills
Ken King, Sierra Club
Mike Ferreira, Sierra Club
Christine Drost-Hansen, Interested Member of the Public
Cathy Campbell, Interested Member of the Public
Lisa Ryan, Interested Member of the Public
Rose Tribble, Interested Member of the Public
Anne Martin, Interested Member of the Public

Envelopes:

Randy Ralston and Linda Mendiola
385 Miramar Drive
Half Moon Bay, CA 94019

Erik Martinez
45 Fremont Street, Suite 2000
San Francisco CA 94105

Lennie Roberts
3921 E. Bayshore Road
Palo Alto, CA 94303

Ken King
3921 East Bayshore Road
Palo Alto, CA 94303

Mike Ferreira
3921 East Bayshore Road
Palo Alto, CA 94303

Christine Drost-Hansen
569 Alto Avenue
Half Moon Bay, CA 94019

Cathy Campbell
555 Hermosa Avenue
Half Moon Bay, CA 94019

Lisa Ryan
548 Hermosa Avenue
Half Moon Bay, CA 94019

Rose Tribble
548 Hermosa Avenue
Half Moon Bay, CA 94019

Anne Martin
620 Miramar Drive
Half Moon Bay, CA 94019

REVISIONS	
DATE	BY

RALSTON - MENDIOLA
HERMOSA AVENUE
HALF MOON BAY, CALIFORNIA 94019

THE DRAWINGS ON THIS SHEET (OR COPIES OF THEM, HOWEVER EXECUTED) AND THE DESIGN CONCEPTS CONVEYED BY THEM ARE AND SHALL REMAIN THE EXCLUSIVE PROPERTY OF THE DESIGNER. WHETHER THE PROJECT FOR WHICH THEY WERE CREATED IS EXECUTED OR NOT, THEY MAY NOT BE USED IN WHOLE OR IN PART BY ANY PERSON OR BUSINESS ENTITY ON ANY OTHER PROJECT OR EXTENSIONS OF THIS PROJECT WITHOUT APPROPRIATE COMPENSATION TO AND WRITTEN PERMISSION FROM THE DESIGNER. THE DESIGNER ASSUMES NO LIABILITY FOR IDEAS NOT EXECUTED BY, OR UNDER THE DIRECT SUPERVISION OF, BLUE SKY DESIGNS, INC.

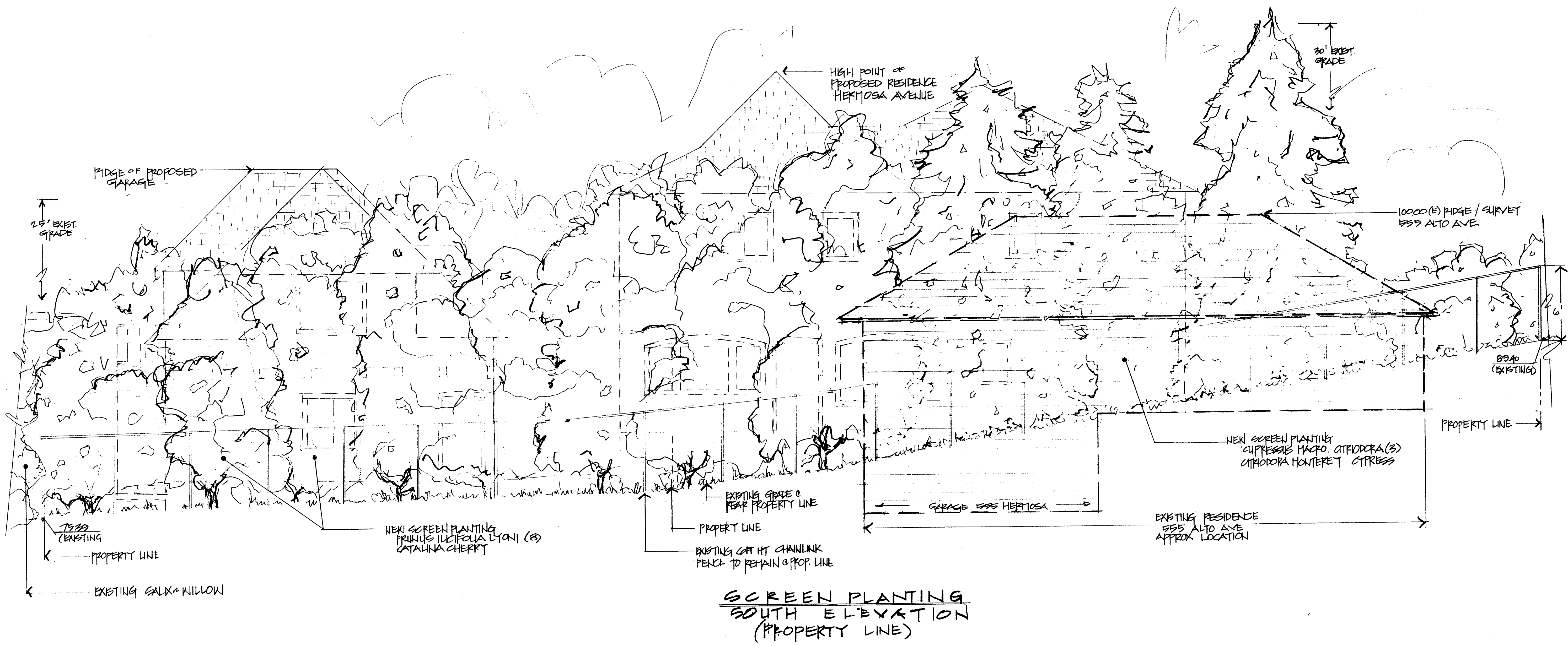

**SCREEN PLANTING
SOUTH ELEVATION
(PROPERTY LINE)**

RECEIVED
JUL 26 2019
San Mateo County
Planning Division

PLN2019-00060

APN: 048-065-190

CHECKED	K.C.
DATE	7/26/19
SCALE	1/4" = 1'-0"
DRAWN	K.C.
TITLE	SCREEN PLANTINGS SOUTH PROPERTY LINE
DWG. NO.	L-2
SHEET	1 OF 1
JOB	RALSTON-MENDIOLA

PROJECT INFORMATION

LOT AREA: 20,012 SQ. FT.
 MAXIMUM LOT COVERAGE: 30% OF LOT AREA (30 x 20,012 = 6,003.60 SQ. FT.)
 PROPOSED LOT COVERAGE: 2780 SQ. FT.
 MAXIMUM BUILDING FLOOR AREA: 53% OF LOT AREA (53 x 20,012 = 10,606.36 SQ. FT.)
 PROPOSED FLOOR AREA: 3975 SQ. FT.
 MAXIMUM IMPERVIOUS SURFACE: 10% OF LOT AREA (10 x 20,012 = 2,001 SQ. FT.)
 PROPOSED IMPERVIOUS SURFACE: 839 SQ. FT.
 FRONT SET BACKS: 20'
 REAR SET BACKS: 20'
 SIDE SET BACK: 10' MIN.
 MAX. SECOND DWELLING: 35% x 2,675 = 936#
 PROPOSED SECOND DWELLING = 650#
 MAXIMUM HEIGHT PERMITTED: 32'
 PROPOSED MAX. HEIGHT: 31'-3 3/4'

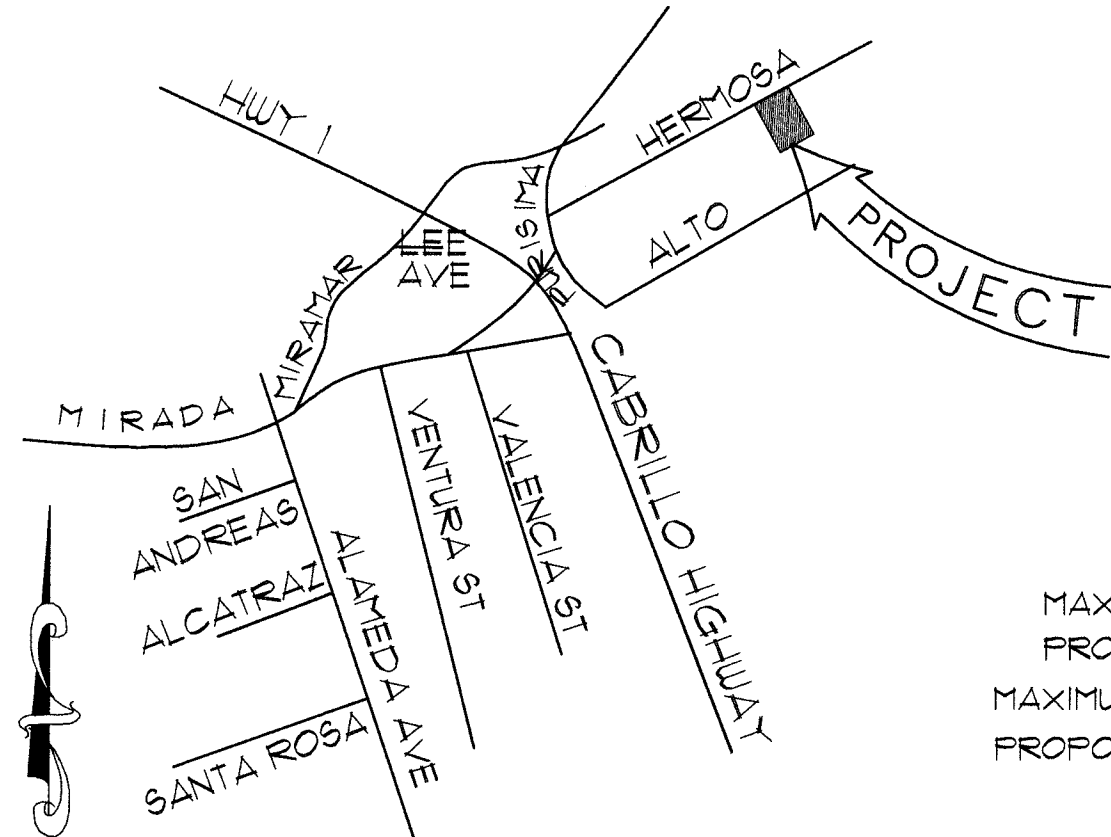

VICINITY MAP NO SCALE PROFESSIONALS

- GEOTECH ENGINEER:**
 SIGMA PRIME GEOSCIENCES INC.
 111 VASSAR ST, HALF MOON BAY, CA 94019
 (650) 728-3590
- SURVEYOR:**
 BGT LAND SURVEYING
 BRYAN G. TAYLOR, PLS
 1920 LESLIE ST., SAN MATEO, CA 94403
 (650) 212-1030
- FIRE SPRINKLER ENGINEERING:**
 PENINSULA FIRE PROTECTION INC.
 1437 PARKWOOD DR, SAN MATEO, CA, 94403
 (650) 713-0108
- LANDSCAPE DESIGNER:**
 BLUE SKY DESIGNS INC.
 4956 FURISSIMA WAY, HALF MOON BAY, CA 94019
 (650) 726-5990
- STRUCTURAL ENGINEER:**
 MIKE O'CONNELL, P.E.
 900 ROSITA ROAD
 PACIFICA, CA 94044
 (650) 303-0495
- BUILDING DESIGNER:**
 SUE TAYLOR
 P. O. BOX 361, CAMINO, CA 95709
 (530) 391-2190

NOTES

- NEW RESIDENTIAL BUILDINGS SHALL HAVE ADDRESS NUMBERS THAT ARE INTERNALLY OR EXTERNALLY ILLUMINATED. THE ADDRESS IDENTIFICATION SHALL BE LEGIBLE AND PLACED IN A POSITION THAT IS VISIBLE FROM THE STREET OR ROAD FRONTING THE PROPERTY. ADDRESS IDENTIFICATION CHARACTERS SHALL CONTRAST WITH THEIR BACKGROUND. ADDRESS NUMBERS SHALL BE ARABIC NUMERALS OR ALPHABETICAL LETTERS. NUMBERS SHALL NOT BE SPELLED OUT. EACH CHARACTER SHALL BE NOT LESS THAN 4 INCHES IN HEIGHT WITH A STROKE OF NOT LESS THAN 0.5 INCH. THE ADDRESS DESIGNATION SHALL BE AT LEAST SIX FEET ABOVE THE FINISHED SURFACE OF THE DRIVEWAY. WHERE ACCESS IS BY MEANS OF A PRIVATE ROAD AND THE BUILDING ADDRESS CANNOT BE VIEWED FROM THE PUBLIC WAY, A MONUMENT, POLE OR OTHER SIGN OR MEANS SHALL BE USED TO IDENTIFY THE STRUCTURE. THE SIGNAGE WILL CONSIST OF A 6 INCH BY 18 INCH REFLECTIVE METAL SIGN WITH 3 INCH REFLECTIVE NUMBERS SIMILAR TO HJ-KO 911 OR EQUIVALENT. (TEMPORARY ADDRESS NUMBERS SHALL BE POSTED PRIOR TO COMBUSTIBLES BEING PLACED ON SITE).
- THE RESIDENCE AND GARAGE SHALL BE PROTECTED BY AN AUTOMATIC FIRE SPRINKLER SYSTEM. SEE PLAN PROVIDED BY PENINSULA FIRE PROTECTION INC.
- A FUELBREAK OR DEFENSIBLE SPACE IS REQUIRED AROUND THE PERIMETER OF ALL STRUCTURES, EXISTING AND NEW, TO A DISTANCE OF NOT LESS THAN 30 FEET AND MAY BE REQUIRED TO A DISTANCE OF 100 FEET OR TO THE PROPERTY LINE. THIS IS NEITHER A REQUIREMENT NOR AN AUTHORIZATION FOR THE REMOVAL OF LIVING TREES.
- TREES LOCATED WITHIN THE DEFENSIBLE SPACE SHALL BE PRUNED TO REMOVE DEAD AND DYING PORTIONS, AND LIMBED UP TO 6 FEET ABOVE THE GROUND. NEW TREES PLANTED IN THE DEFENSIBLE SPACE SHALL BE LOCATED NO CLOSER THAN 10 FEET TO ADJACENT TREES WHEN FULLY GROWN OR AT MATURITY.
- REMOVE THAT PORTION OF ANY EXISTING TREES, WHICH EXTENDS WITHIN 10 FEET OF THE OUTLET OF A CHIMNEY OF STOVEPIPE OR IS WITHIN 5 FEET OF ANY STRUCTURE. REMOVE THAT PORTION OF ANY EXISTING TREES, WHICH EXTENDS WITHIN 10 FEET OF THE OUTLET OF A CHIMNEY OR STOVEPIPE OR IS WITHIN 5 FEET OF ANY STRUCTURE. MAINTAIN ANY TREE ADJACENT TO OR OVERHANGING A BUILDING FREE OF DEAD OR DYING WOOD.
- NEW POWER AND TELEPHONE UTILITY LINE FROM THE STREET OR NEAREST EXISTING UTILITY POLE TO THE MAIN DWELLING AND/OR ANY OTHER STRUCTURE ON THE PROPERTY SHALL BE PLACED UNDERGROUND.

SITE STATEMENT

THE INFORMATION SHOWN ON THIS PLOT PLAN WAS PROVIDED BY BGT LAND SURVEYING. NO FIELD SURVEY OR VERIFICATION WAS MADE. REFER TO BGT LAND SURVEYING SHEET FOR SURVEY AND SITE PLAN.
 THE IRON PIPE AT THE ANGLE POINT IN THE WHITE PICKET FENCE AT THE CORNER OF FURISSIMA WAY AND MIRAMAR DRIVE WAS USED AS THE BENCHMARK FOR THIS SURVEY, AS PER SAN MATEO COUNTY FIELD NOTES DATED 1-1-94, FIELD BOOK 123-16, PAGE 5.

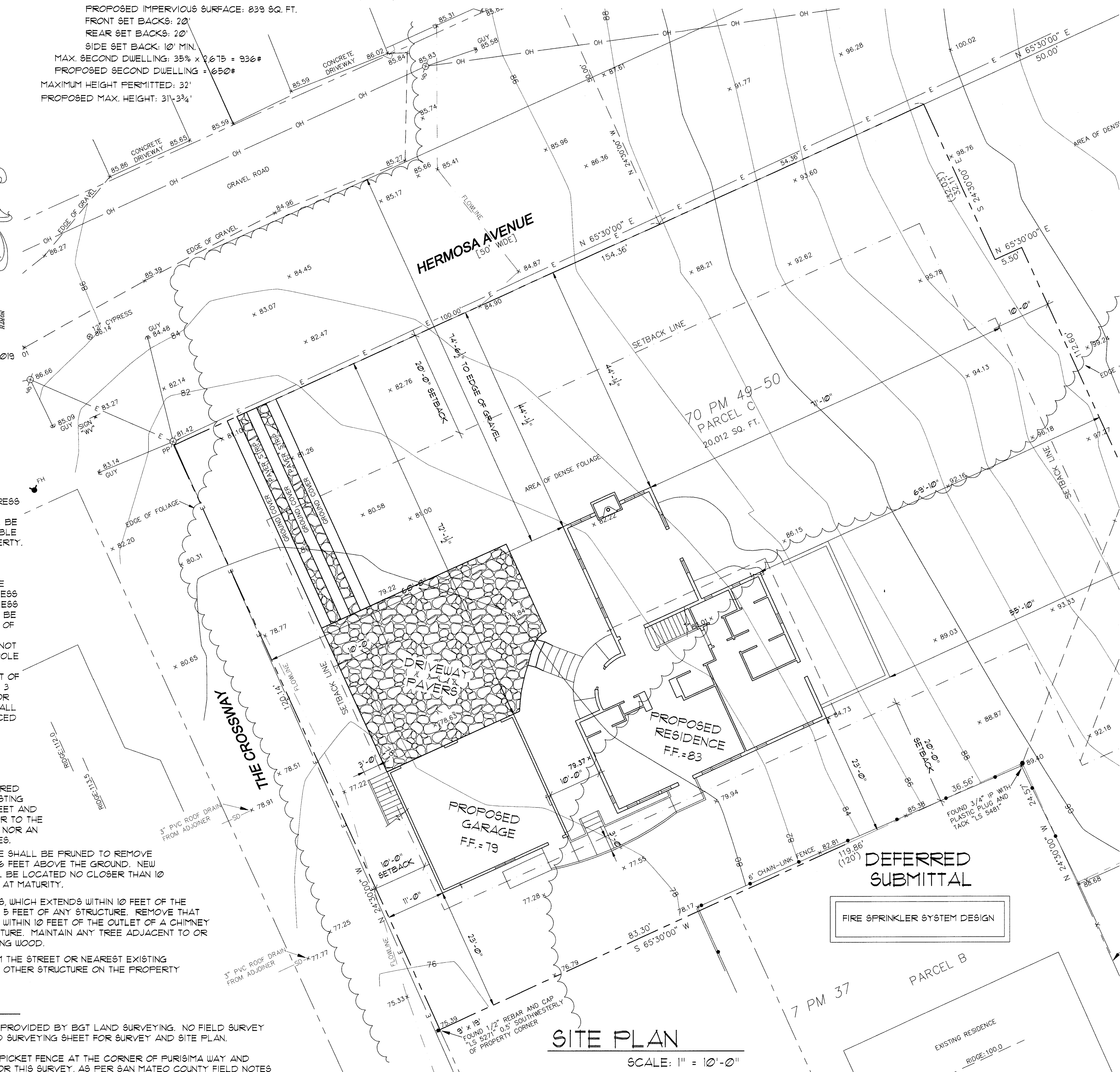

SITE PLAN
SCALE: 1" = 10'-0"

GENERAL INFORMATION

OWNER: RANDY RALSTON & LINDA MENDIOLA
 385 MIRAMAR DRIVE
 HALF MOON BAY, CA 94019

SITE ADDRESS: HERMOSA AVENUE
 HALF MOON BAY, CA 94019

PHONE: (650) 245-5613

PROJECT: NEW RESIDENCE

BUILDING INFORMATION

OCCUPANCY CODE: R-3 / U
 2016 CALIFORNIA RESIDENTIAL CODE, BUILDING, PLUMBING, MECHANICAL, FIRE, ELECTRICAL CODES, CALIFORNIA TITLE 24 ENERGY CODE, GREEN BUILDING STANDARDS CODE, WILDLAND-URBAN INTERFACE 2016 CRC SECTION R331.

FLOOR AREA (2 STORY):

FIRST FLOOR AREA	1614#
SECOND FLOOR AREA	952#
SECOND FLOOR AREA OVER GARAGE	650#
TOTAL LIVING AREA :	3216#
GARAGE AREA	650#
2ND FLOOR COVERED DECK	109#
TOTAL FLOOR AREA:	3975#

BUILDING TYPE: V-B
DESIGN LOADS: ROOF 20 psf, FLOOR 40 psf, LIVE LIVE

SITE INFORMATION

JURISDICTION: COUNTY OF SAN MATEO
ASSESSOR'S PARCEL NO.: 048-065-190
SITE AREA: 20,012 SQ. FT.
ZONE: R-1/8-94/DR/CD
WATER: PUBLIC
SEWAGE DISPOSAL: PUBLIC

ENERGY STATEMENT

THE BUILDING SHOWN ON THESE PLANS SUBSTANTIALLY CONFORMS TO THE REQUIREMENTS OF TITLE 24 PART 2, CHAPTER 2-53, OF THE CALIFORNIA ADMINISTRATION CODE. SEE CALCULATIONS.

OWNER & BUILDER'S NOTE

THESE PLANS WERE PREPARED BY SUE TAYLOR, DESIGNER, FOR THE EXCLUSIVE USE OF HER CLIENT AT THE SPECIFIC SITE SHOWN. NO OTHER USE OR DUPLICATION OF THESE PLANS IS PERMITTED WITHOUT HER PERMISSION.

THESE PLANS SHALL NOT BE USED FOR CONSTRUCTION UNTIL STAMPED BY ENGINEER FOR NON-CONVENTIONAL STRUCTURAL FEATURES AND APPROVED BY THE LOCAL BUILDING DEPARTMENT. THE BUILDER IS EXPECTED TO FOLLOW THESE PLANS, APPLICABLE BUILDING CODES, AND LOCAL ORDINANCES. HE SHALL VERIFY THAT SITE CONDITIONS ARE CONSISTENT WITH THESE PLANS BEFORE STARTING WORK. WHILE THESE PLANS ARE DRAUN TO SHOW THE PROPOSED WORK AS ACCURATELY AS POSSIBLE, SCHEMATIC DETAILS MAY BE USED IN SOME CASES FOR CLARITY. WORK NOT SPECIFICALLY DETAILED SHALL BE CONSTRUCTED TO THE SAME QUALITY AS SIMILAR WORK THAT IS DETAILED.

WRITTEN DIMENSIONS AND SPECIFIC NOTES SHALL TAKE PRECEDENCE OVER SCALED DIMENSIONS AND GENERAL NOTES. IF CONFLICTING INFORMATION IS SHOWN, THE MORE STRINGENT SHALL GOVERN. THE ENGINEER/DESIGNER SHALL BE CONSULTED FOR CLARIFICATION IF EXISTING CONDITIONS ARE ENCOUNTERED THAT ARE DIFFERENT THAN SHOWN, IF DISCREPANCIES ARE FOUND IN THE PLANS OR NOTES, OR IF A QUESTION ARISES OVER THE INTENT OF THE PLANS OR NOTES.

THE ENGINEER/DESIGNER ASSUMES NO RESPONSIBILITY FOR SCHEDULING, FABRICATION, CONSTRUCTION TECHNIQUES (INCLUDING SHORING), OR MATERIALS, OR QUANTITIES USED IN THE WORK. THE ENGINEER/DESIGNER ASSUMES NO RESPONSIBILITY FOR FIELD CHANGES, SITE VARIANCES OR DISCREPANCIES NOT BROUGHT TO HIS/HER ATTENTION FOR CLARIFICATION. LIABILITY TO THE DESIGNER SHALL BE LIMITED TO THE DESIGN FEE.

SHEET INDEX

PAGE #	TITLE	SHEET #
1.)	COVER SHEET / SITE PLAN	C-1.1
2.)	LANDSCAPE PLAN - BY BLUE SKY DESIGNS, INC.	L1
3.)	GRADING AND DRAINAGE PLAN - BY SIGMA PRIME	C-1
4.)	EROSION & SEDIMENT CONTROL PLAN - BY SIGMA PRIME	C-2
5.)	BMP SHEET	C-1.3
6.)	FIRST FLOOR AND GARAGE PLAN	A1-1.1
7.)	SECOND FLOOR AND STUDIO APT OVER GARAGE PLAN	A1-1.2
8.)	EAST & WEST ELEVATIONS	A1-2.1
9.)	NORTH & SOUTH ELEVATIONS	A1-2.2
10.)	BUILDING SECTIONS	A1-3.1
11.)	COUNTY FIRE WORKSHEETS	FI-1.1

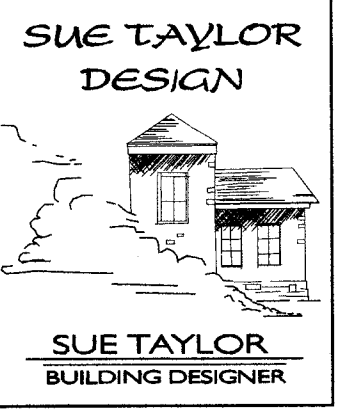

P.O. BOX 361
 CAMINO, CA 95709
 (530) 391-2190
 suetaylor@earthlink.net

NEW RESIDENCE
 COVER SHEET
 SITE PLAN

RANDY RALSTON & LINDA MENDIOLA
 HERMOSA AVENUE
 HALF MOON BAY, CA 94019

REVISION	DATE	DESCRIPTION
1	4-7-19	REVISION PER COUNTY FIRE 5-3-19
2	6-21-19	REVISION PER DESIGN REVIEW 6-13-19
3	1-24-20	REVISION PER DESIGN REVIEW 1-11-20

Sue Taylor

DATE: FEBRUARY 07, 2019

DESIGNED BY: SRT
 DRAIN BY: SRT
 CHECKED BY: SRT

FILE # PROJECTS2019021001C1
 PROJECT 190201

PAGE 1 OF 11

SHEET NO. C-1.1

REVISIONS

DATE	BY

RALSTON - MENDIOLA
HERMOSA AVENUE
HALF MOON BAY, CALIFORNIA 94019

THE DRAWINGS ON THIS SHEET (OR COPIES OF THEM) HEREBY EXECUTED AND THE DESIGN CONCEPTS CONVEYED BY THEM ARE AND SHALL REMAIN THE EXCLUSIVE PROPERTY OF THE DESIGNER. WHETHER THE PROJECT FOR WHICH THEY WERE CREATED IS EXECUTED OR NOT, THEY MAY NOT BE USED IN WHOLE OR IN PART BY ANY PERSON OR BUSINESS ENTITY OR ANY OTHER PROJECT NOR EXTENDING OF THIS PROJECT WITHOUT APPROPRIATE PERMISSION TO AND WRITTEN PERMISSION FROM THE DESIGNER. THE DESIGNER ASSUMES NO LIABILITY FOR REASONING EXECUTED BY, OR UNDER THE DIRECT SUPERVISION OF, BLUE SKY DESIGNS, INC.

CHECKED **KC.**
DATE **6/20/19**
SCALE **1" = 10'-0"**
DRAWN **KC.**
TITLE
LANDSCAPE PLAN
DWG. NO.
L-1
SHEET 1 OF 1
JOB
RALSTON-MENDIOLA

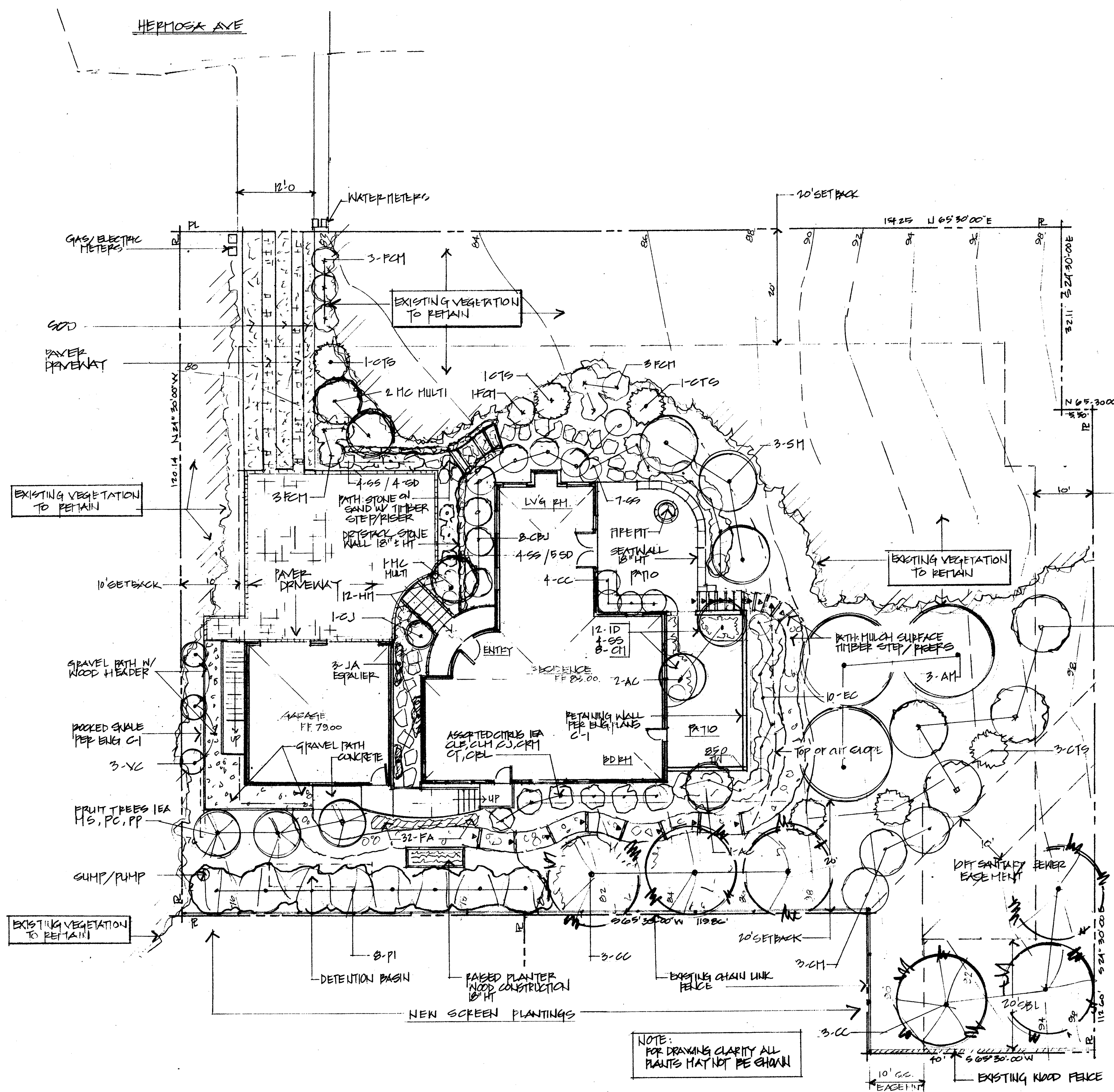

NOTE:
FOR DRAWING CLARITY ALL
PLANTS MAY NOT BE SHOWN

Key	Qty.	Size	Name	Common Name	Growth Rate	Ave. Size	Dead/Event	CA Native	Coast
TREES:									
AC	3	18 Gal.	Acer glaberrimum	Vine Maple	Moderate	10 ft. x 10'	Deciduous		X
AM	3	18 Gal.	Acer macrophyllum	Bigleaf Maple	Moderate	50ft x 25 ft.	Deciduous		
CLM	1	5 Gal.	Citrus Lemon var. 'Improved Meyer' dwarf	Meyer Lemon	Moderate	7 ft. x 9'	Evergreen		
CLE	1	5 Gal.	Citrus Lemon var. 'Eureka' dwarf	Eureka Lemon	Moderate	7 ft. x 9'	Evergreen		
CLB	1	5 Gal.	Citrus Lime var. 'Bearss Lime' dwarf	Bearss Lime	Moderate	7 ft. x 9'	Evergreen		
CJ	1	5 Gal.	Citrus japonica	Kanquat	Moderate	15 ft. x 8'	Evergreen		
CRH	1	5 Gal.	Citrus reticulata x medica dwarf	Rangpur Lime (lemon x mandarin)	Moderate	7 ft. x 9'	Evergreen		
CT	1	5 Gal.	Citrus tangerina	Tangerine	Moderate	7 ft. x 9'	Evergreen		
CC	6	5 Gal.	Cupressus macrocarpa 'Chirodora'	Chirodora Monterey Cypress	Fast	30 ft. x 15'	Evergreen	X	X
MB	1	5 Gal.	Malus spp.	Apple	Moderate	15 ft. x 15'	Deciduous		
PI	8	5 Gal.	Prunus ficifolia lyonii	Catalina Cherry	Moderate	15 ft. x 15'	Evergreen	X	X
PP	1	5 Gal.	Prunus plum/avocet	Puot	Moderate	15 ft. x 15'	Deciduous		
PC	1	5 Gal.	Pyrus communis	Pear	Moderate	30 ft. x 30'	Deciduous		
SHRUBS:									
Key	Qty.	Size	Name	Common Name	Growth Rate	Ave. Size	Dead/Event	CA Native	Coast
CJ	1	15 Gal.	Camellia japonica	Camellia	Moderate	10 ft.	Evergreen		
CC	4	5 Gal.	Carantheria californica	Bush Anemone	Slow	6' ht x 6'	Evergreen	X	X
CBJ	8	5 Gal.	Ceanothus Blue Jeans	Ceanothus	Moderate	5' ht x 5'	Evergreen	X	X
CTS	6	5 Gal.	Ceanothus thyrsiflorus 'Snow Flurry'	Ceanothus - white	Moderate	6' ht x 10'	Evergreen	X	X
PCM	9	5 Gal.	Fraxinus (Rhamnus) californica 'Mound San Bruno'	Coffeeberry	Moderate	12 ft. x 12'	Evergreen	X	X
GE	4	5 Gal.	Garrya elliptica	Coccoloba	Moderate	12 ft. x 12'	Evergreen	X	X
MC	3	5 Gal.	Myrica californica - shrub	Pacific Wax Myrtle	Moderate	15ft x 15 ft.	Evergreen	X	X
MCM	4	5 Gal.	Myrica californica - multi trunk	Pacific Wax Myrtle	Moderate	15ft x 15 ft.	Evergreen	X	X
BM	3	1 Gal.	Sambucus mexicana	Blue Elderberry	Moderate	15ft x 15 ft.	Deciduous	X	X
ESPALEERS:									
Key	Qty.	Size	Name	Common Name	Growth Rate	Ave. Size	Dead/Event	CA Native	Coast
CJA	3	5 Gal.	Camellia japonica 'Alba Plena'	ESPALEER Camellia	Moderate	10 ft.	Evergreen		
PERENNIALS:									
Key	Qty.	Size	Name	Common Name	Growth Rate	Ave. Size	Dead/Event	CA Native	Coast
CM	15	1 Gal.	Campanula murillo	Bellflower	Moderate	8' ht. X 1'	Evergreen		
HM	15	1 Gal.	Heuchera maxima	Island Alum Root	Moderate	2 ft. X 1'	Evergreen	X	X
EC	10	1 Gal.	Euphorbia californica (Zauschneria)	California Fuchsia	Moderate	2ft x 2 ft.	Evergreen	X	X
ID	15	1 Gal.	Inc douglasiana	Douglas Iris	Fast	2 ft. x 1'	Deciduous	X	X
SB	15	1 Gal.	Salvia apathacea	Hummingbird Sage	Moderate	1 ft. spreading	Perennial	X	X
VINES:									
Key	Qty.	Size	Name	Common Name	Growth Rate	Ave. Size	Dead/Event	CA Native	Coast
VC	3	1 Gal.	Vitis californica Roger's Red	California Wild Grape Roger's Red	Moderate	30ft.	Deciduous	X	X
GROUNDCOVER:									
Key	Qty.	Size	Name	Common Name	Growth Rate	Ave. Size	Dead/Event	CA Native	Coast
FA	32	4 in.	Fragaria x ananassa	Strawberry- edibe	Moderate	6' ht.	Evergreen		
SD	12	1 Gal.	Satureja douglasii	Yerba Buena	Moderate	6'ht x 3ft.	Evergreen	X	X
SOD:									
Key	Qty.	Size	Name	Common Name	Growth Rate	Ave. Size	Dead/Event	CA Native	Coast
SOD	260	8"	Ca native Fescue mix. Source: Delta Bluegrass	Native No Mow	Fast	NA	Evergreen	X	X

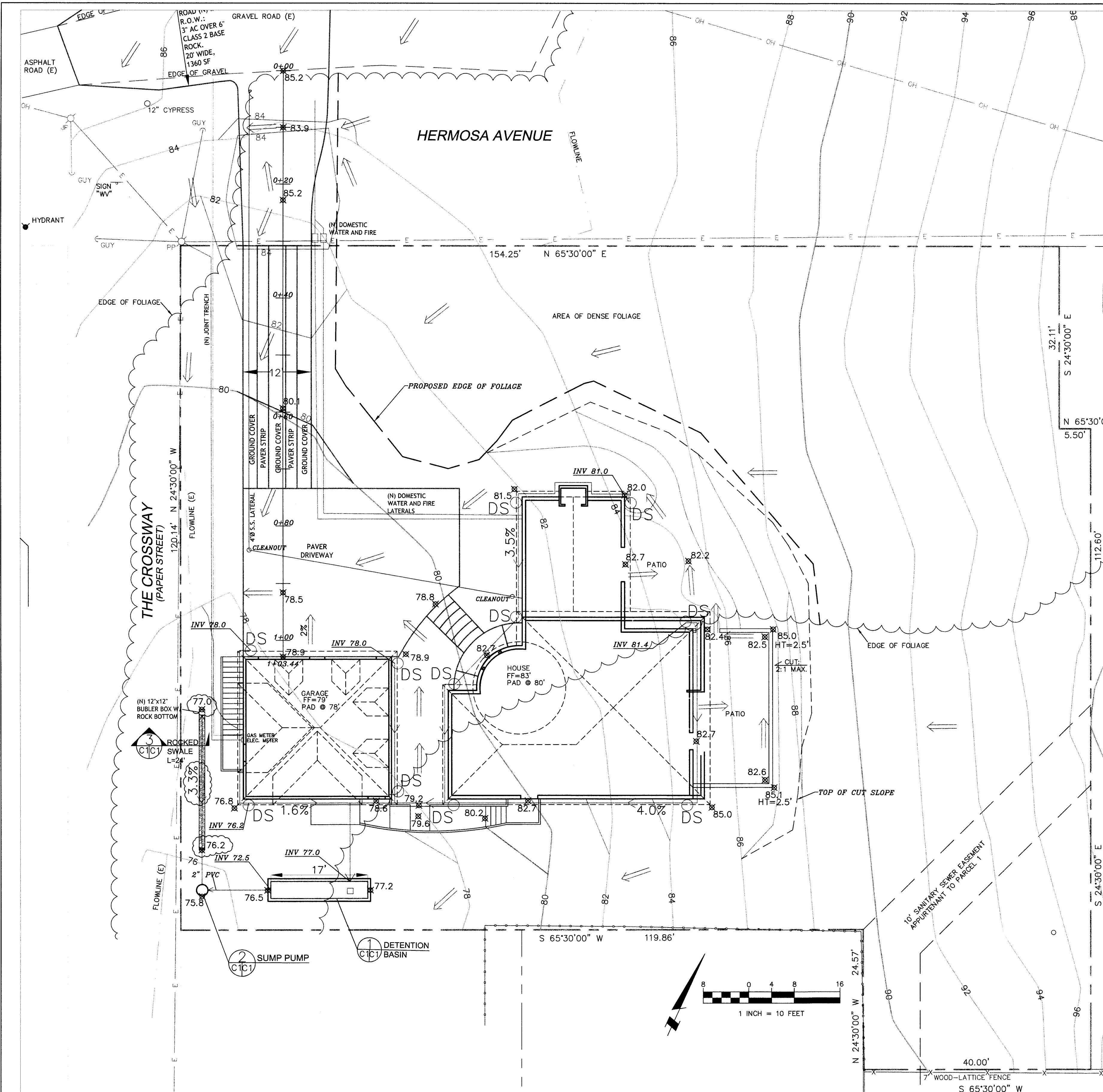

- LEGEND**
- 1' CONTOUR (E)
 - 5' CONTOUR (E)
 - PROPOSED CONTOUR
 - 220.7 PROPOSED SPOT ELEVATION
 - DS DOWNSPOUT
 - 4" SOLID DRAIN PIPE

- GENERAL NOTES**
1. PLANS PREPARED AT THE REQUEST OF: RANDY RALSTON, OWNER, 385 MIRAMAR DRIVE, HALF MOON BAY, CA 94019, TEL: 650-245-5613, EMAIL: RALSMEND@COMCAST.NET
 2. TOPOGRAPHY BY BGT LAND SURVEYING.
 3. THIS IS NOT A BOUNDARY SURVEY.
 4. ELEVATION DATUM: NGVD 29.
- GRADING NOTES**
- CUT VOLUME: 200 CY
FILL VOLUME: 25 CY
1. ABOVE VOLUMES ARE APPROXIMATE.
 2. ALL GRADING SHALL CONFORM TO LOCAL CODES AND ORDINANCES.
 3. ALL TRENCHES IN PROPOSED LANDSCAPE AREAS SHALL BE BACKFILLED WITH COMPACTED APPROVED GRANULAR MATERIAL TO WITHIN ONE FOOT OF FINISHED GRADE, AND THEN FILLED WITH HAND TAMPED SOILS.

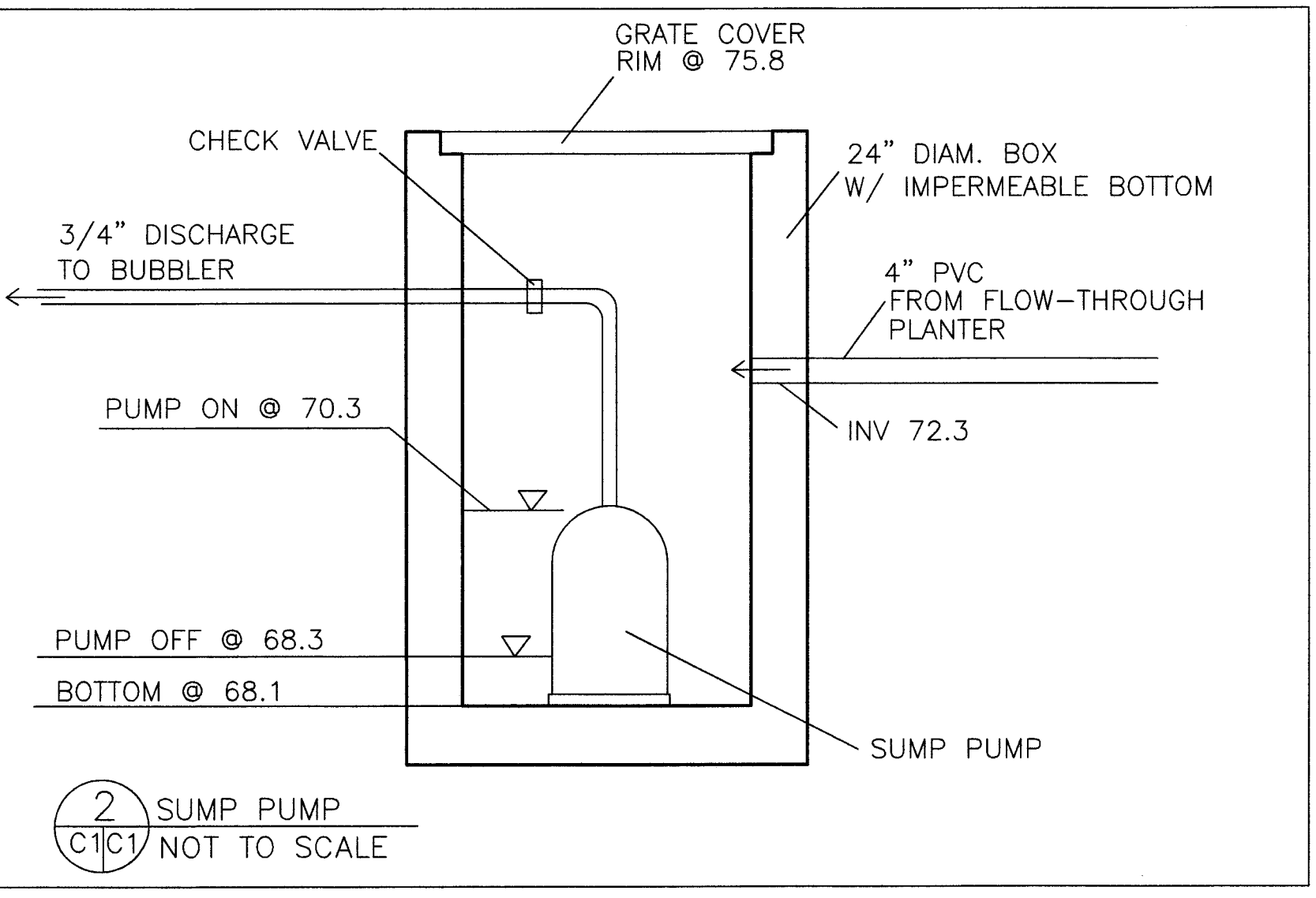
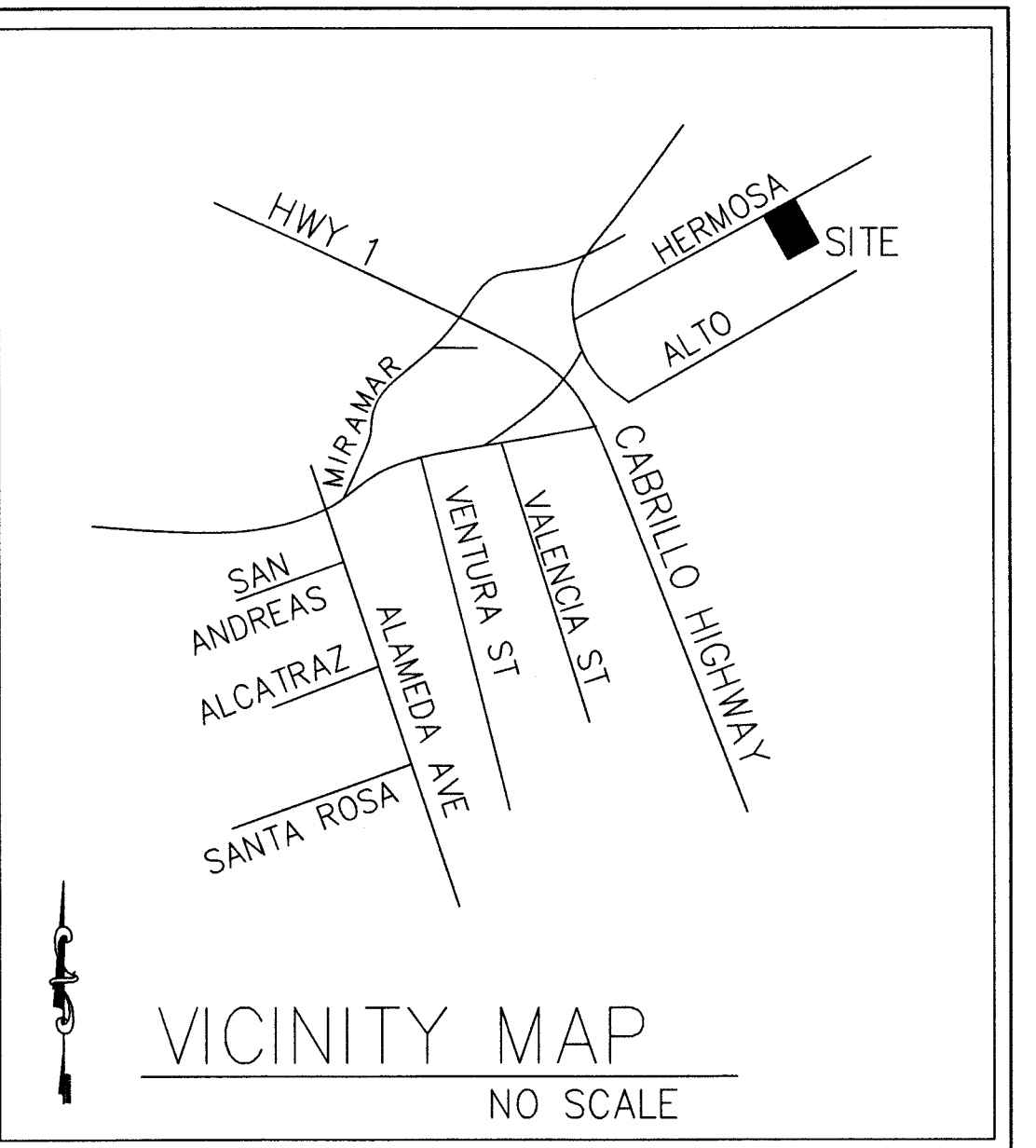

- DRAINAGE NOTES**
1. DRAINAGE INTENT: IT IS THE INTENT OF THE DRAINAGE SYSTEM TO CONVEY ROOF RUNOFF TO A SAFE LOCATION, AND TO MINIMIZE EXCESSIVE MOISTURE AROUND FOUNDATIONS.
 2. ALL ROOF DRAIN LINES SHALL LEAD TO FLOW-THROUGH PANTER, AS SHOWN.
 3. ALL DRAINAGE PIPES SHALL BE MINIMUM 4" DIAMETER SOLID PIPE, SLOPED AT 1% MINIMUM.
 4. AREAS OF PERVIOUS GROUND SHALL SLOPE AWAY FROM BUILDING A 5% WITHIN 10 FEET OF BUILDING, WHERE SPACE PERMITS.

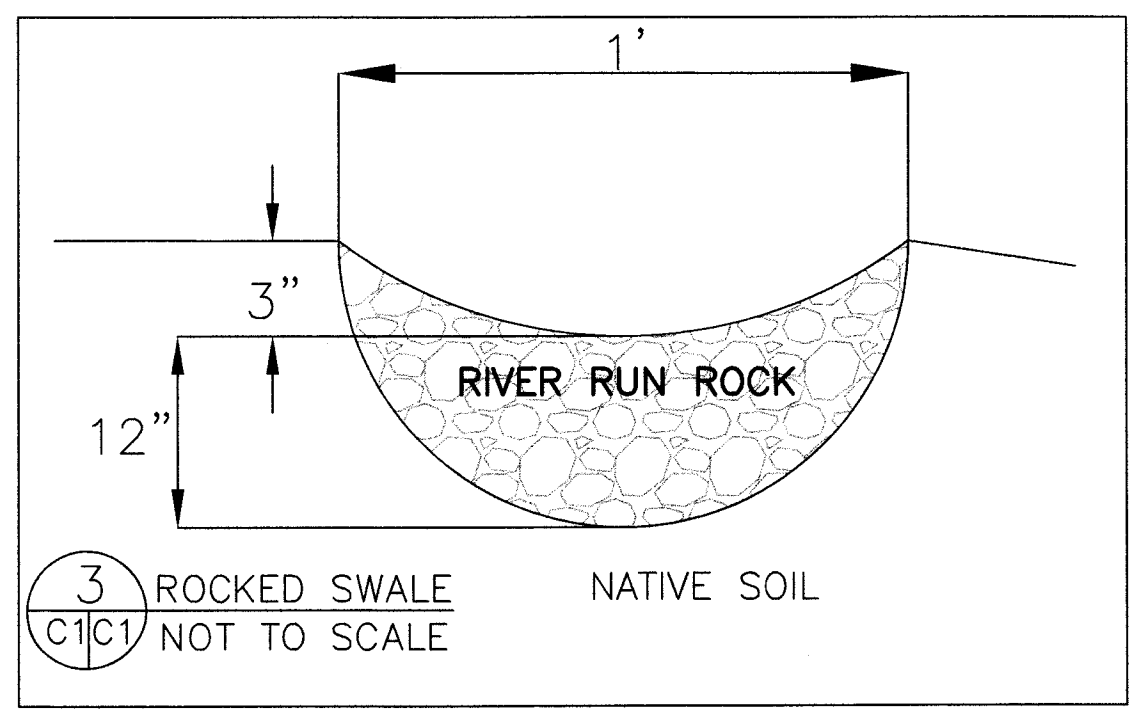
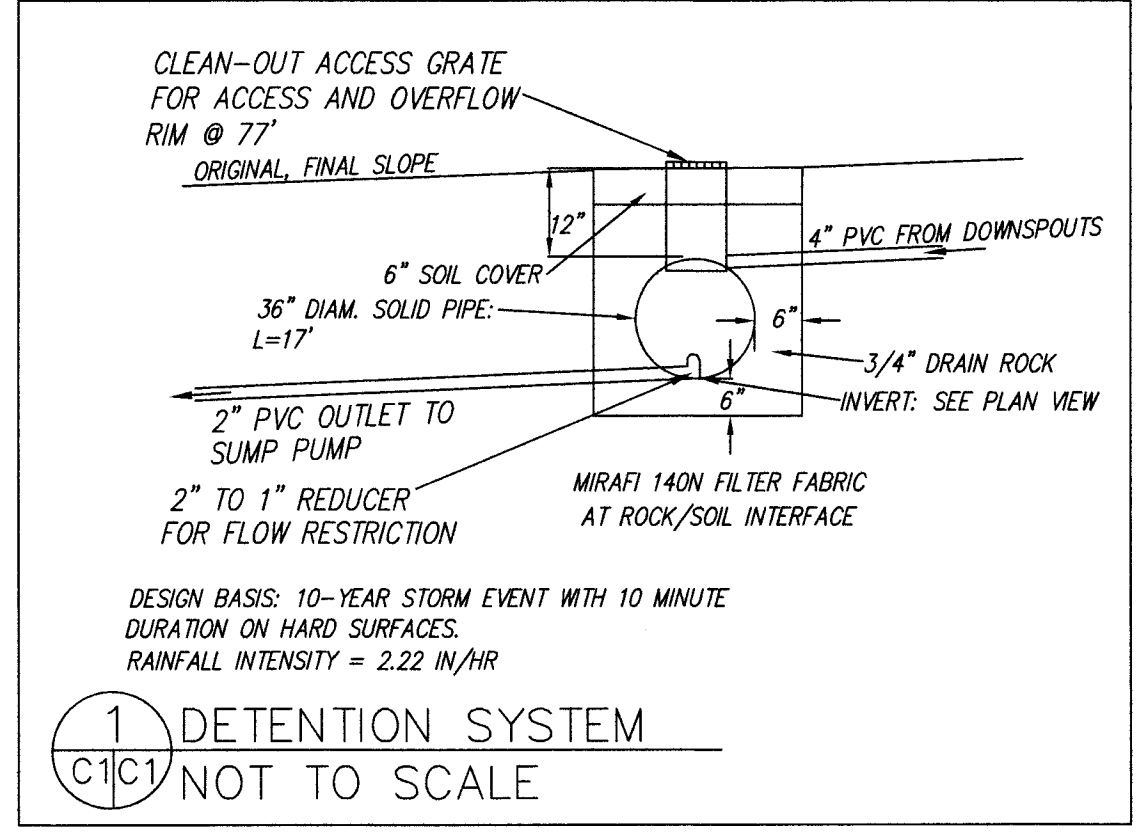
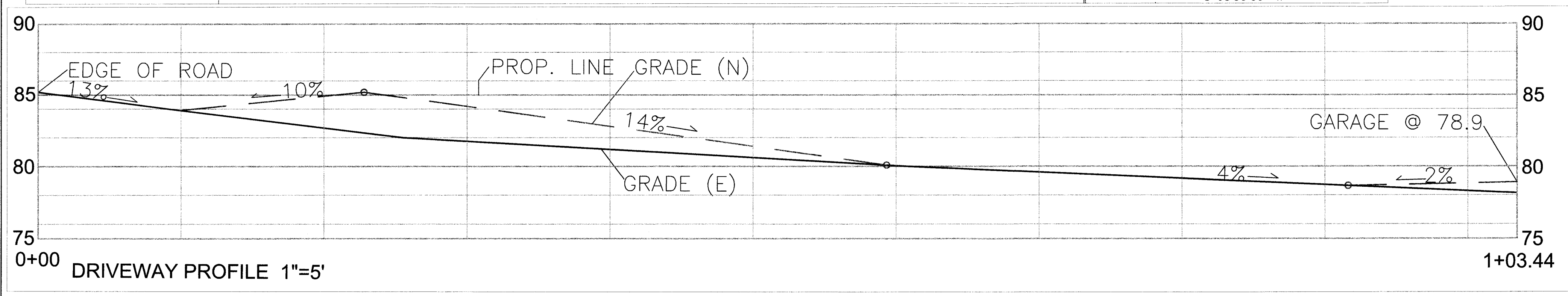
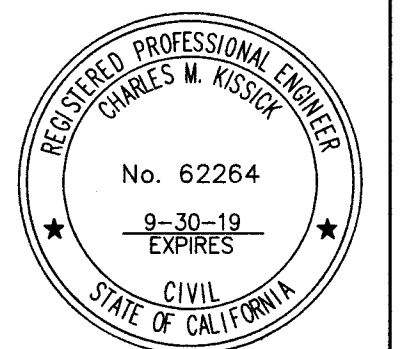

GRADING AND DRAINAGE PLAN

RALSTON PROPERTY
HERMOSA AVENUE
MIRAMAR
APN 048-065-190

SHEET
C-1

Sigma Prime Geosciences, Inc.
SIGMA PRIME GEOSCIENCES, INC.
332 PRINCETON AVENUE
HALF MOON BAY, CA 94019
(650) 728-3590
FAX 728-3593

DATE: 4-9-19	DRAWN BY: CMK	CHECKED BY: AZG	REV. DATE: 7-24-19	REV. DATE:	REV. DATE:
--------------	---------------	-----------------	--------------------	------------	------------

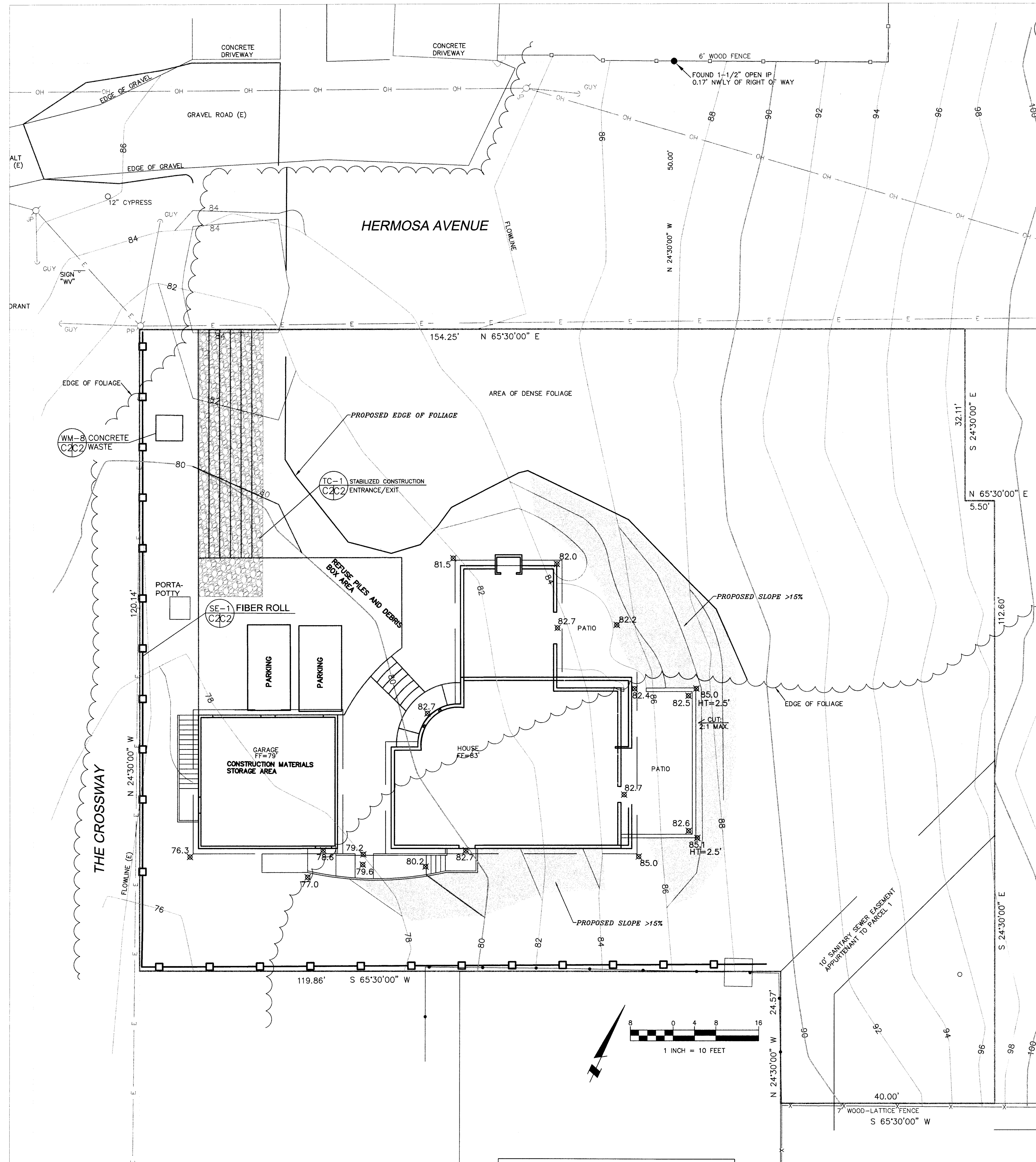

EROSION CONTROL NOTES

- 1. GRADING MAY TAKE PLACE DURING WET WEATHER AFTER OCTOBER 1 PROVIDED THE FOLLOWING PROVISIONS ARE FOLLOWED.
- 2. NO GRADING SHALL TAKE PLACE DURING RAINY WEATHER OR FOR A PERIOD OF AT LEAST 24 HOURS FOLLOWING RAIN.
- 3. ALL EXPOSED SOIL SHALL BE TEMPORARILY PROTECTED FROM EROSION WITH JUTE NETTING.
- 4. ALL STOCKPILED SOIL SHALL BE COVERED AT ALL TIMES AND REMOVED FROM SITE AS SOON AS POSSIBLE, IF SCHEDULED FOR OFF-HAUL.
- 5. ALL EXPOSED SURFACES SHALL BE PERMANENTLY PROTECTED FROM EROSION WITH SEEDING AND/OR LANDSCAPING. SEED MIX SHALL BE 75 LB PER ACRE ANNUAL RYGRASS OR APPROVED SUBSTITUTE. SEED SHALL BE COVERED WITH STRAW MULCH AT A RATE OF 2 TONS/ACRE.
- 6. ROCKED CONSTRUCTION ENTRANCE SHALL BE 50 FEET LONG BY 12 FEET WIDE AND CONFORM TO THE FOLLOWING:
 - A. THE MATERIAL FOR THE PAD SHALL BE 3 TO 6 INCH STONE.
 - B. PAD SHALL BE NOT LESS THAN 12" THICK.
 - C. THE ENTRANCE SHALL BE MAINTAINED IN A CONDITION THAT WILL PREVENT TRACKING OR FLOWING OF SEDIMENT ONTO PUBLIC RIGHT-OF-WAY. THIS MAY REQUIRE PERIODIC TOP DRESSING WITH ADDITIONAL STONE AS CONDITIONS DEMAND, AND REPAIR AND/OR CLEANOUT OF ANY MEASURES USED TO TRAP SEDIMENT. ALL SEDIMENT SPILLED, DROPPED, WASHED, OR TRACKED ONTO PUBLIC RIGHT-OF-WAY SHALL BE REMOVED IMMEDIATELY.
 - D. WHEN NECESSARY, WHEELS SHALL BE CLEANED TO REMOVE SEDIMENT PRIOR TO ENTRANCE ONTO PUBLIC RIGHT-OF-WAY. WHEN WASHING IS REQUIRED, IT SHALL BE DONE ON AN AREA THAT DRAINS TO THE CONCRETE WASHOUT AREA.
- 7. CONCRETE WASHOUT AREA SHALL BE SURROUNDED BY A SINGLE LAYER OF SAND BAGS TO CONTAIN FLUIDS. CHANNEL INTO AREA SHALL BE CLEARED TO ALLOW TIRE DEBRIS (SEE NOTE 6.D. ABOVE).

CONCRETE WASTE MANAGEMENT WM-8

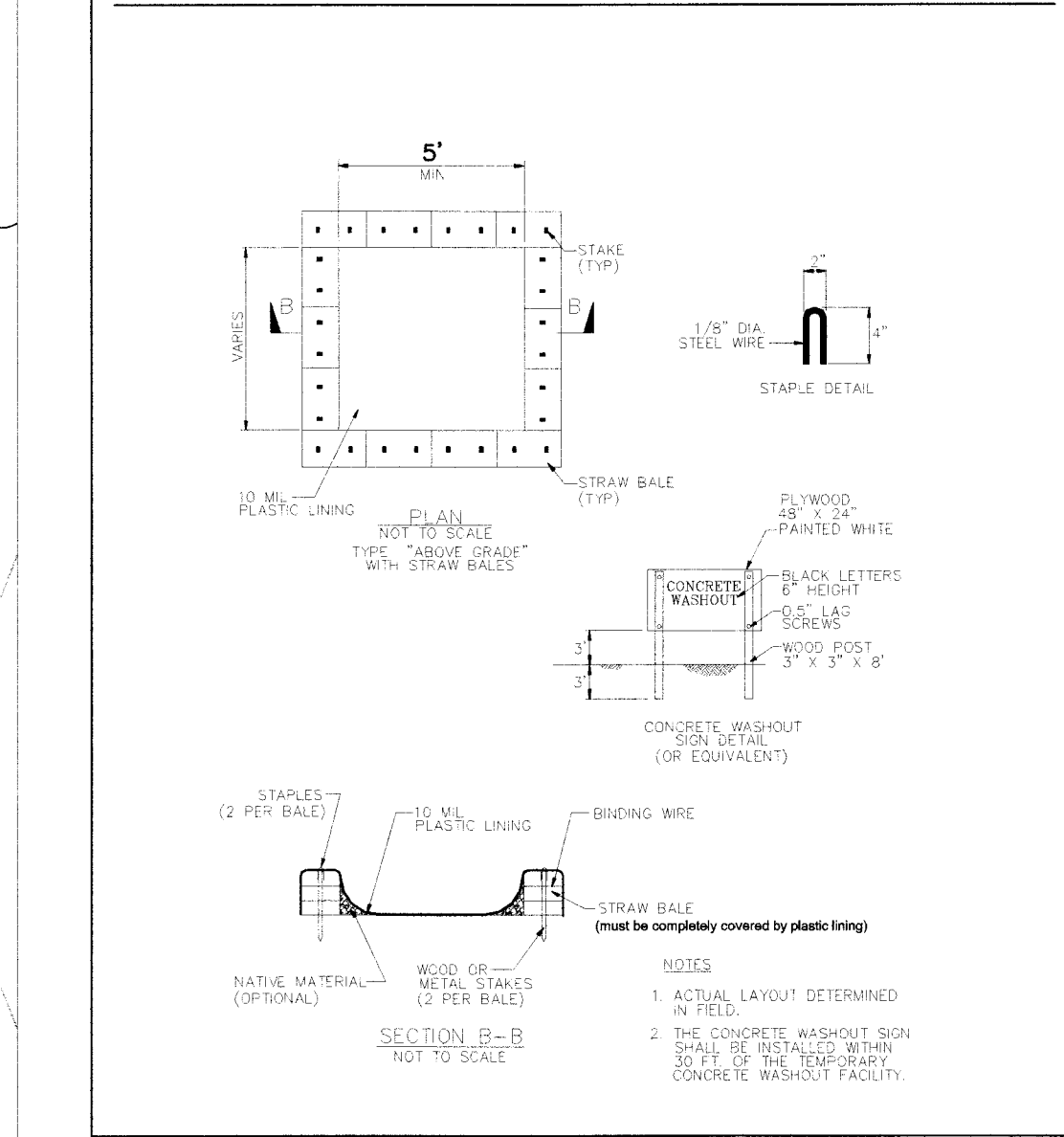

FIBER ROLLS SE-5

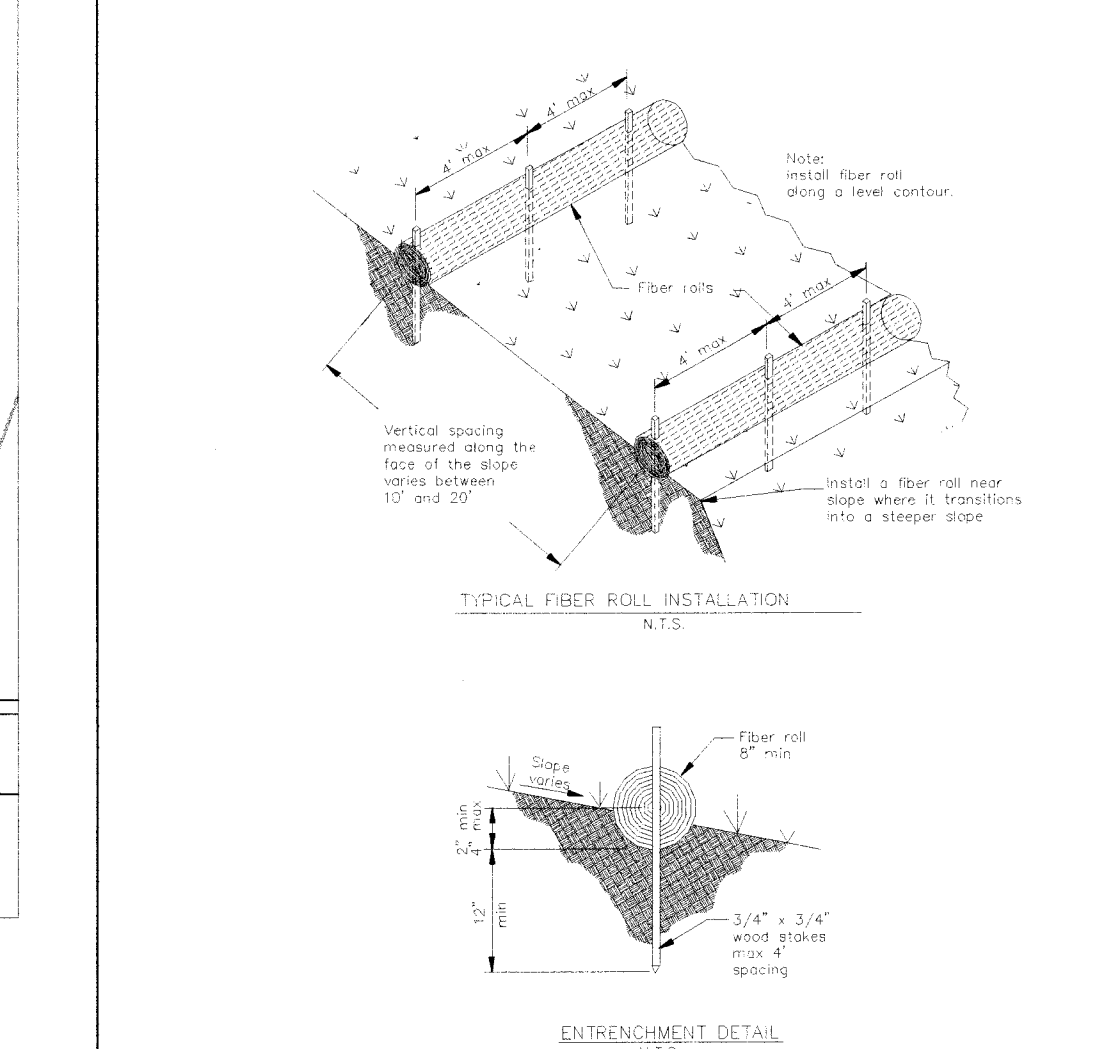

GENERAL EROSION AND SEDIMENT CONTROL NOTES

- There will be no stockpiling of soil. All excavated soil will be hauled off-site as it is excavated.
- Perform clearing and earth-moving activities only during dry weather. Measures to ensure adequate erosion and sediment control shall be installed prior to earth-moving activities and construction.
- Erosion control materials to be on-site during off-season.
- Measures to ensure adequate erosion and sediment control are required year-round. Stabilize all denuded areas and maintain erosion control measures continuously between October 1 and April 30.
- Store, handle, and dispose of construction materials and wastes properly, so as to prevent their contact with stormwater.
- Control and prevent the discharge of all potential pollutants, including pavement cutting wastes, paints, concrete, petroleum products, chemicals, wash water or sediments, and non-stormwater discharges to storm drains and watercourses.
- Avoid cleaning, fueling, or maintaining vehicles on-site, except in a designated area where wash water is contained and treated.
- Limit and time applications of pesticides and fertilizers to prevent polluted runoff.
- Limit construction access routes to stabilized, designated access points
- Avoid tracking dirt or other materials off-site; clean off-site paved areas and sidewalks using dry sweeping methods.
- Train and provide instruction to all employees and subcontractors regarding the Watershed Protection Maintenance Standards and construction Best Management Practices.
- Placement of erosion materials is required on weekends and during rain events.
- The areas delineated on the plans for parking, grubbing, storage etc., shall not be enlarged or "run over."
- Dust control is required year-round.
- Erosion control materials shall be stored on-site
- The tree protection shall be in place before any grading, excavating or grubbing is started.

EROSION CONTROL POINT OF CONTACT

THIS PERSON WILL BE RESPONSIBLE FOR EROSION CONTROL AT THE SITE AND WILL BE THE COUNTY'S MAIN POINT OF CONTACT IF CORRECTIONS ARE REQUIRED.

NAME: RANDY RALSTON
 TITLE/QUALIFICATION: OWNER/CONTRACTOR
 PHONE: 650-245-5613
 PHONE:
 E-MAIL: RALSMEND@COMCAST.NET



Sigma Prime Geosciences, Inc.
 SIGMA PRIME GEOSCIENCES, INC.
 332 PRINCETON AVENUE
 HALF MOON BAY, CA 94019
 (650) 728-3590
 FAX 728-3593

DATE: 2-11-19
 DRAWN BY: CMK
 CHECKED BY: AZG
 REV. DATE: 7-24-19
 REV. DATE:
 REV. DATE:

EROSION AND SEDIMENT CONTROL PLAN
RALSTON PROPERTY
HERMOSA AVENUE
MIRAMAR
APN 048-065-190

SHEET
C-2

STABILIZED CONSTRUCTION ENTRANCE/EXIT TC-1

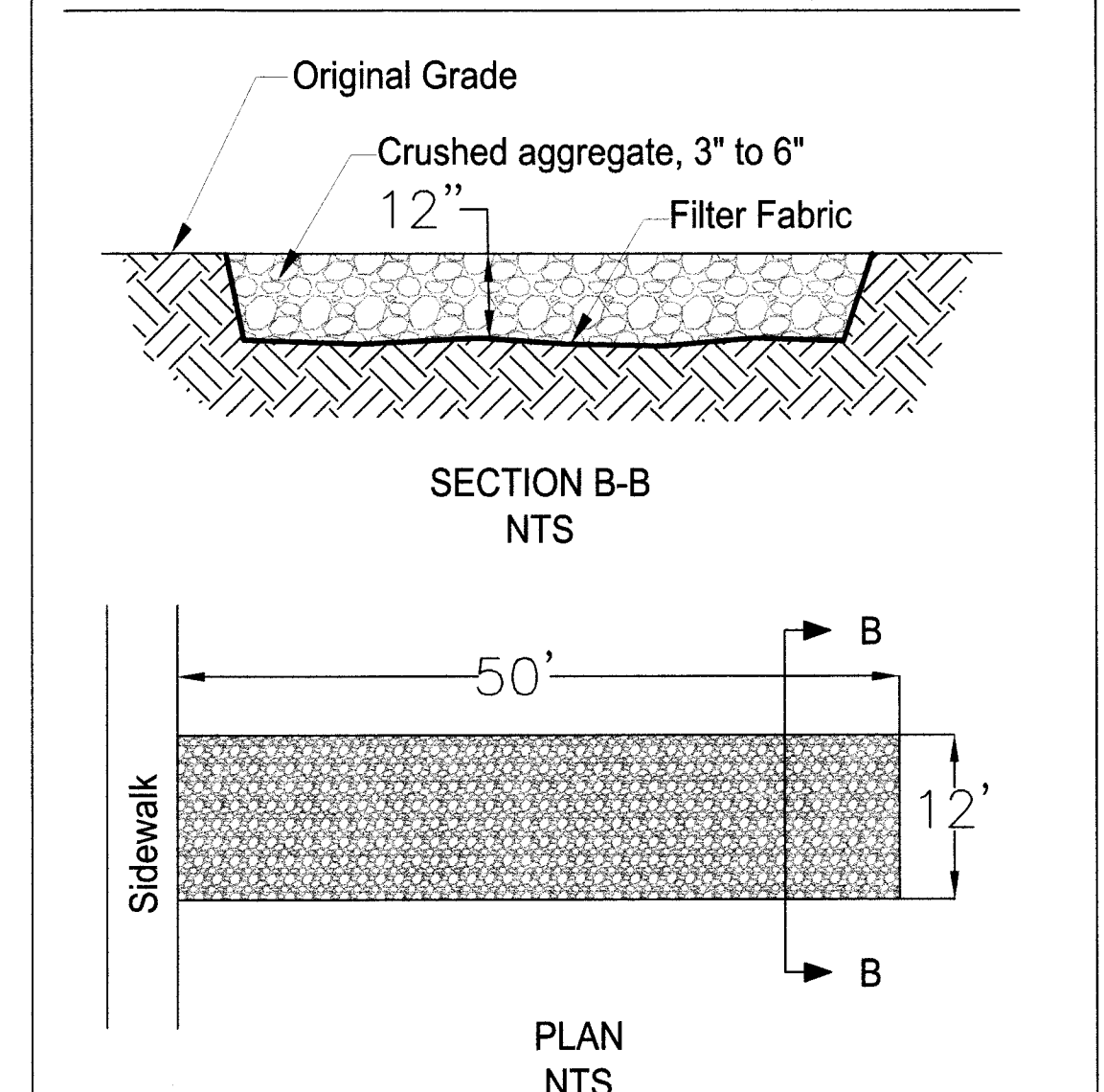



SAN MATEO COUNTYWIDE
**Water Pollution
Prevention Program**
Clean Water. Healthy Community.

Construction Best Management Practices (BMPs)

Construction projects are required to implement the stormwater best management practices (BMP) on this page, as they apply to your project, all year long.

Materials & Waste Management

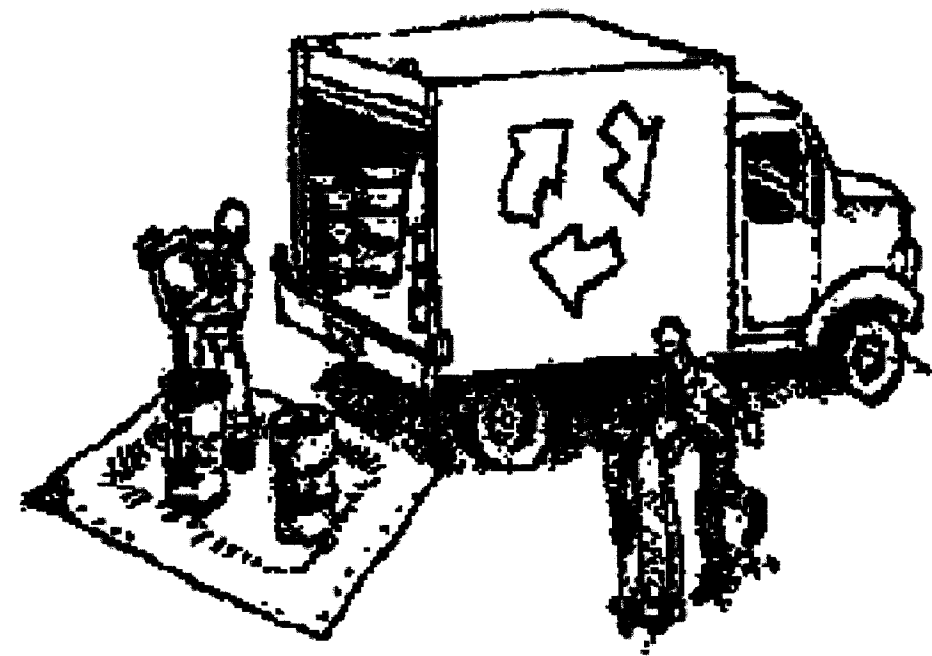

Non-Hazardous Materials

- Berm and cover stockpiles of sand, dirt or other construction material with tarps when rain is forecast or if not actively being used within 14 days.
- Use (but don't overuse) reclaimed water for dust control.

Hazardous Materials

- Label all hazardous materials and hazardous wastes (such as pesticides, paints, thinners, solvents, fuel, oil, and antifreeze) in accordance with city, county, state and federal regulations.
- Store hazardous materials and wastes in water tight containers, store in appropriate secondary containment, and cover them at the end of every work day or during wet weather or when rain is forecast.
- Follow manufacturer's application instructions for hazardous materials and be careful not to use more than necessary. Do not apply chemicals outdoors when rain is forecast within 24 hours.
- Arrange for appropriate disposal of all hazardous wastes.

Waste Management

- Cover waste disposal containers securely with tarps at the end of every work day and during wet weather.
- Check waste disposal containers frequently for leaks and to make sure they are not overfilled. Never hose down a dumpster on the construction site.
- Clean or replace portable toilets, and inspect them frequently for leaks and spills.
- Dispose of all wastes and debris properly. Recycle materials and wastes that can be recycled (such as asphalt, concrete, aggregate base materials, wood, gyp board, pipe, etc.)
- Dispose of liquid residues from paints, thinners, solvents, glues, and cleaning fluids as hazardous waste.

Construction Entrances and Perimeter

- Establish and maintain effective perimeter controls and stabilize all construction entrances and exits to sufficiently control erosion and sediment discharges from site and tracking off site.
- Sweep or vacuum any street tracking immediately and secure sediment source to prevent further tracking. Never hose down streets to clean up tracking.

Equipment Management & Spill Control

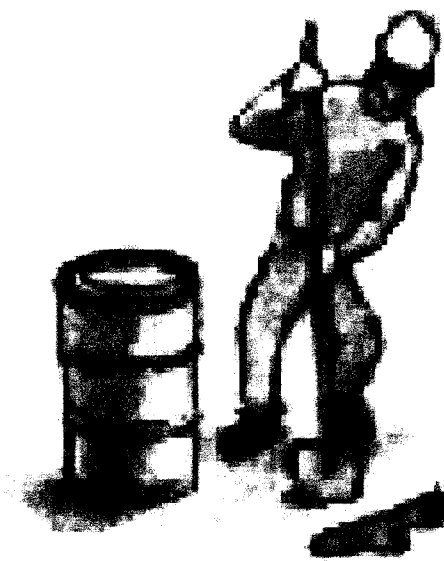

Maintenance and Parking

- Designate an area, fitted with appropriate BMPs, for vehicle and equipment parking and storage.
- Perform major maintenance, repair jobs, and vehicle and equipment washing off site.
- If refueling or vehicle maintenance must be done onsite, work in a bermed area away from storm drains and over a drip pan or drop cloths big enough to collect fluids. Recycle or dispose of fluids as hazardous waste.
- If vehicle or equipment cleaning must be done onsite, clean with water only in a bermed area that will not allow rinse water to run into gutters, streets, storm drains, or surface waters.
- Do not clean vehicle or equipment onsite using soaps, solvents, degreasers, or steam cleaning equipment.

Spill Prevention and Control

- Keep spill cleanup materials (e.g., rags, absorbents and cat litter) available at the construction site at all times.
- Inspect vehicles and equipment frequently for and repair leaks promptly. Use drip pans to catch leaks until repairs are made.
- Clean up spills or leaks immediately and dispose of cleanup materials properly.
- Do not hose down surfaces where fluids have spilled. Use dry cleanup methods (absorbent materials, cat litter, and/or rags).
- Sweep up spilled dry materials immediately. Do not try to wash them away with water, or bury them.
- Clean up spills on dirt areas by digging up and properly disposing of contaminated soil.
- Report significant spills immediately. You are required by law to report all significant releases of hazardous materials, including oil. To report a spill: 1) Dial 911 or your local emergency response number, 2) Call the Governor's Office of Emergency Services Warning Center, (800) 852-7550 (24 hours).

Earthmoving



- Schedule grading and excavation work during dry weather.
- Stabilize all denuded areas, install and maintain temporary erosion controls (such as erosion control fabric or bonded fiber matrix) until vegetation is established.
- Remove existing vegetation only when absolutely necessary, and seed or plant vegetation for erosion control on slopes or where construction is not immediately planned.
- Prevent sediment from migrating offsite and protect storm drain inlets, gutters, ditches, and drainage courses by installing and maintaining appropriate BMPs, such as fiber rolls, silt fences, sediment basins, gravel bags, berms, etc.
- Keep excavated soil on site and transfer it to dump trucks on site, not in the streets.

Contaminated Soils

- If any of the following conditions are observed, test for contamination and contact the Regional Water Quality Control Board:
 - Unusual soil conditions, discoloration, or odor.
 - Abandoned underground tanks.
 - Abandoned wells
 - Buried barrels, debris, or trash.

Paving/Asphalt Work



- Avoid paving and seal coating in wet weather or when rain is forecast, to prevent materials that have not cured from contacting stormwater runoff.
- Cover storm drain inlets and manholes when applying seal coat, tack coat, slurry seal, fog seal, etc.
- Collect and recycle or appropriately dispose of excess abrasive gravel or sand. Do NOT sweep or wash it into gutters.
- Do not use water to wash down fresh asphalt concrete pavement.

Sawcutting & Asphalt/Concrete Removal

- Protect nearby storm drain inlets when saw cutting. Use filter fabric, catch basin inlet filters, or gravel bags to keep slurry out of the storm drain system.
- Shovel, absorb, or vacuum saw-cut slurry and dispose of all waste as soon as you are finished in one location or at the end of each work day (whichever is sooner!).
- If sawcut slurry enters a catch basin, clean it up immediately.

Concrete, Grout & Mortar Application



- Store concrete, grout, and mortar away from storm drains or waterways, and on pallets under cover to protect them from rain, runoff, and wind.
- Wash out concrete equipment/trucks offsite or in a designated washout area, where the water will flow into a temporary waste pit, and in a manner that will prevent leaching into the underlying soil or onto surrounding areas. Let concrete harden and dispose of as garbage.
- When washing exposed aggregate, prevent washwater from entering storm drains. Block any inlets and vacuum gutters, hose washwater onto dirt areas, or drain onto a bermed surface to be pumped and disposed of properly.

Landscaping



- Protect stockpiled landscaping materials from wind and rain by storing them under tarps all year-round.
- Stack bagged material on pallets and under cover.
- Discontinue application of any erodible landscape material within 2 days before a forecast rain event or during wet weather.

Painting & Paint Removal

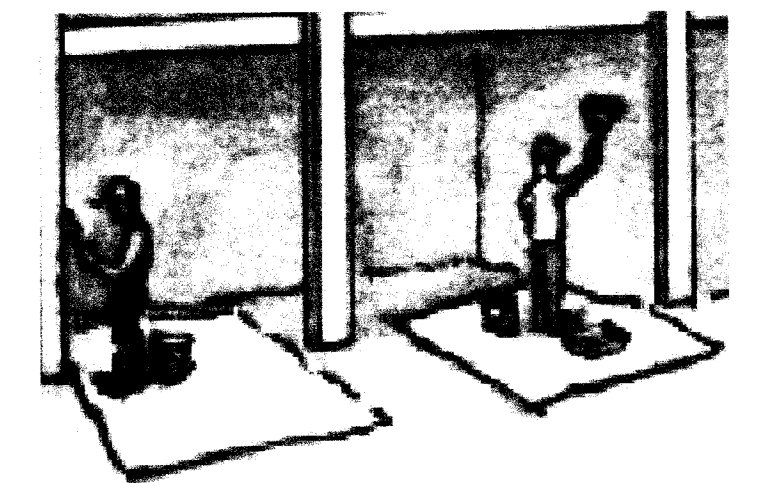

Painting Cleanup and Removal

- Never clean brushes or rinse paint containers into a street, gutter, storm drain, or stream.
- For water-based paints, paint out brushes to the extent possible, and rinse into a drain that goes to the sanitary sewer. Never pour paint down a storm drain.
- For oil-based paints, paint out brushes to the extent possible and clean with thinner or solvent in a proper container. Filter and reuse thinners and solvents. Dispose of excess liquids as hazardous waste.
- Paint chips and dust from non-hazardous dry stripping and sand blasting may be swept up or collected in plastic drop cloths and disposed of as trash.
- Chemical paint stripping residue and chips and dust from marine paints or paints containing lead, mercury, or tributyltin must be disposed of as hazardous waste. Lead based paint removal requires a state-certified contractor.

Dewatering

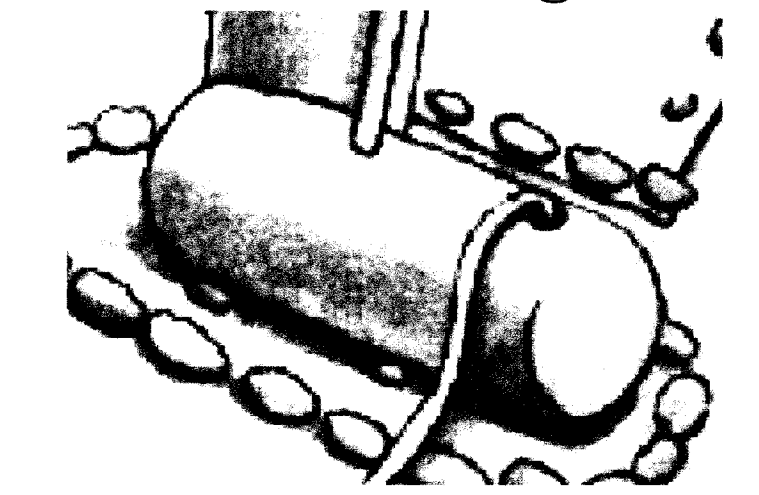

- Discharges of groundwater or captured runoff from dewatering operations must be properly managed and disposed. When possible send dewatering discharge to landscaped area or sanitary sewer. If discharging to the sanitary sewer call your local wastewater treatment plant.
- Divert run-on water from offsite away from all disturbed areas.
- When dewatering, notify and obtain approval from the local municipality before discharging water to a street gutter or storm drain. Filtration or diversion through a basin, tank, or sediment trap may be required.
- In areas of known or suspected contamination, call your local agency to determine whether the ground water must be tested. Pumped groundwater may need to be collected and hauled off-site for treatment and proper disposal.

Storm drain polluters may be liable for fines of up to \$10,000 per day!

WALL SCHEDULE

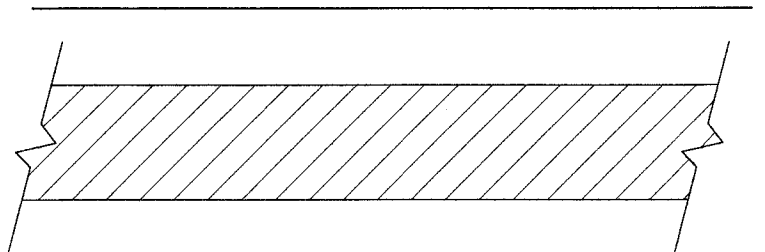

- EXTERIOR WALLS AND WALL SEPARATING THE HOUSE AND GARAGE TO BE 2x6

- INTERIOR WALLS TO BE 2x4 EXCEPT FOR INTERIOR WALLS MARKED AS BELOW SHALL BE 2x6.



TILE FLOORS REQUIRE THINSET, 1/4" HARDIEBACKER CEMENT BOARD AND A MAXIMUM WEIGHT OF CERAMIC TILE OF 4.1 psf.

TABLE R302.6

SEPARATION	MATERIAL
FROM THE RESIDENCE AND ATTICS	NOT LESS THAN 1/2-INCH GYPSUM BOARD OR EQUIVALENT APPLIED TO THE GARAGE SIDE.
FROM ALL HABITABLE ROOMS ABOVE THE GARAGE OR CARPORT	NOT LESS THAN 5/8-INCH TYPE X GYPSUM BOARD OR EQUIVALENT.
STRUCTURE(S) SUPPORTING FLOOR/CEILING ASSEMBLIES USED FOR SEPARATION REQUIRED BY THIS SECTION.	NOT LESS THAN 1/2-INCH GYPSUM BOARD OR EQUIVALENT.
GARAGES LOCATED LESS THAN 3 FEET FROM A DWELLING UNIT ON THE SAME LOT.	NOT LESS THAN 1/2-INCH GYPSUM BOARD OR EQUIVALENT APPLIED TO THE INTERIOR SIDE OF THE EXTERIOR WALLS THAT ARE WITHIN THIS AREA.

WINDOW SCHEDULE

DH	DOUBLE HUNG
SH	SINGLE HUNG
SL	SLIDER
CM	CASEMENT
TR	TRANSOM
F	FIXED
Ⓣ	TEMPERED

GENERAL NOTES

REFERENCE THE ELECTRICAL PLAN FOR LOCATION AND SPECIFICATIONS OF SMOKE DETECTORS AND OTHER ELECTRICAL REQUIREMENTS.

ATTIC ACCESS SHALL BE:

REQUIRED IN A BUILDING WITH COMBUSTIBLE CEILING OR ROOF CONSTRUCTION WITH A VERTICAL HEIGHT OF 30" OR GREATER OVER AN AREA OF NOT LESS THAN 30 SQ. FT. THE VERTICAL HEIGHT SHALL BE MEASURED FROM THE TOP OF THE CEILING FRAMING MEMBERS TO THE UNDERSIDE OF THE ROOF FRAMING MEMBERS.

NOT LESS THAN 22" x 30" AT THE ROUGH-FRAMED OPENING.

LOCATED IN A CORRIDOR, HALLWAY OR OTHER READILY ACCESSIBLE LOCATION, WHERE LOCATED IN A WALL, THE ROUGH OPENING SHALL BE NOT LESS THAN 22" WIDE BY 30" HIGH. WHEN THE ACCESS IS LOCATED IN A CEILING, MINIMUM UNOBSTRUCTED HEADROOM IN THE ATTIC SPACE SHALL BE 30" AT SOME POINT ABOVE THE ACCESS MEASURED VERTICALLY FROM THE BOTTOM OF CEILING FRAMING MEMBERS. SEE THE CALIFORNIA MECHANICAL CODE FOR ACCESS REQUIREMENTS WHERE MECHANICAL EQUIPMENT IS LOCATED IN ATTICS PER 2016 R302.1.

WINDOWS AND GLAZING

WINDOWS SHALL BE DUAL PANE

EMERGENCY AND ESCAPE RESCUE OPENINGS SHALL HAVE A NET CLEAR OPENING OF NOT LESS THAN 5.7 SQ. FT. 5.0 SQ. FT. ALLOWED AT GRADE. THE NET CLEAR OPENING DIMENSIONS REQUIRED BY THIS SECTION SHALL BE OBTAINED BY THE NORMAL OPERATION OF THE EMERGENCY ESCAPE AND RESCUE OPENING FROM THE INSIDE. THE NET CLEAR HEIGHT OPENINGS SHALL BE NOT LESS THAN 24" AND THE NET CLEAR WIDTH SHALL BE NOT LESS THAN 20 INCHES. FINISHED SILL HEIGHT SHALL BE NOT MORE THAN 44 INCHES ABOVE THE FINISHED FLOOR.

RESCUE WINDOWS IN BEDROOMS ARE LABELED AS EGRESS, CONTRACTOR / OWNER TO VERIFY THAT THEY MEET ALL REQUIREMENTS.

ALL GLAZING LESS THAN 60 INCHES ABOVE A SHOWER OR TUB FLOOR, GLAZING ADJACENT TO STAIRWAYS, LANDINGS AND RAMPS WITHIN 36 INCHES HORIZONTALLY OF A WALKING SURFACE WHEN THE EXPOSED SURFACE OF THE GLAZING IS LESS THAN 60 INCHES ABOVE THE PLANE OF THE ADJACENT WALKING SURFACES AND GLAZING IN ALL FIXED AND OPERABLE PANELS OF SWINGING, SLIDING AND BI-FOLD DOORS SHALL BE TEMPERED GLAZING PER 2016 CRC R308.4.

SHOWER COMPARTMENTS AND WALLS ABOVE BATHTUBS WITH INSTALLED SHOWER HEADS SHALL BE FINISHED WITH A NONABSORBENT SURFACE TO A HEIGHT OF NOT LESS THAN 6 FEET ABOVE THE FLOOR PER CRC 307.2.

PER CBC 308.4.3 GLAZING IN AN INDIVIDUAL FIXED OR OPERABLE PANEL THAT MEETS ALL OF THE FOLLOWING CONDITIONS SHALL BE CONSIDERED TO BE A HAZARDOUS LOCATION:

1. THE EXPOSED AREA OF AN INDIVIDUAL PANE IS LARGER THAN 9 SQ. FT. AND
2. THE BOTTOM EDGE OF THE GLAZING IS LESS THAN 18 INCHES ABOVE THE FLOORS AND
3. THE TOP EDGE OF THE GLAZING IS MORE THAN 36 INCHES ABOVE THE FLOOR AND
4. ONE OR MORE WALKING SURFACES ARE WITHIN 36 INCHES MEASURED HORIZONTALLY AND IN A STRAIGHT LINE, OF THE GLAZING.

DOOR SCHEDULE

1. SOLID WOOD DOORS NOT LESS THAN 1-3/8 INCHES (35 MM) IN THICKNESS, SOLID OR HONEYCOMB CORE STEEL DOORS NOT LESS THAN 1-3/8 INCHES (35 MM) THICK, OR 20-MINUTE FIRE-RATED DOORS. DOORS SHALL BE SELF-CLOSING AND SELF-LATCHING DEVICE. SEE GENERAL NOTES FOR EXCEPTION.

2. 36" EXTERIOR EXIT DOOR - NET CLEAR DOOR WAY SHALL BE 32". DOOR SHALL BE OPENABLE FROM INSIDE WITHOUT THE USE OF A KEY OR ANY SPECIAL KNOWLEDGE OR EFFORT. DOOR SHALL SWING TO THE FULL OPEN POSITION WHEN AN OPENING FORCE NOT EXCEEDING 30 lbs. IS APPLIED TO THE LATCH SIDE. GLAZING IN DOORS SHALL BE DUAL PANE SAFETY GLASS WITH MIN. U-VALUE OF 0.60. PERIMETER OF DOOR SHALL BE WEATHER STRIPPED. GLAZING IN DOORS SHALL BE DUAL PANE SAFETY GLASS.

3. EXTERIOR DOORS SHALL COMPLY WITH ONE OF THE FOLLOWING:
1. THE EXTERIOR SURFACE OR CLADDING SHALL BE OF NONCOMBUSTIBLE OR IGNITION-RESISTANT MATERIAL, OR
2. SHALL BE CONSTRUCTED OF SOLID CORE WOOD THAT COMPLY WITH THE FOLLOWING REQUIREMENTS:
2.1 STILES AND RAILS SHALL NOT BE LESS THAN 1 3/8" THICK
2.2 RAISED PANELS SHALL NOT BE LESS THAN 1 1/4" THICK, EXCEPT FOR THE EXTERIOR PERIMETER OF THE RAISED PANEL THAT MAY TAPER TO A TONGUE NOT LESS THAN 3/8" THICK
2.3 SHALL HAVE A FIRE-RESISTANCE RATING OF NOT LESS THAN 20 MINUTES WHEN TESTED ACCORDING TO NFPA 252.
2.4 SHALL BE TESTED TO MEET THE PERFORMANCE REQUIREMENTS OF SFM STANDARD 12-TA-1.
GLAZING IN DOORS SHALL BE DUAL PANE SAFETY GLASS.

4. INTERIOR DOORS - HOLLOW CORE

5. SECTIONAL HIGH LIFT OVERHEAD DOOR

EXTERIOR DOORS AND DOORS LEADING TO GARAGE SHALL HAVE SINGLE CYLINDER DEAD BOLT IN ADDITION TO DOOR LATCHES.

GLASS SLIDING DOORS SHALL BE SUPPLEMENTED WITH AN AUXILIARY DOOR LOCK OR PASS STRESS TEST.

LANDING

PROVIDE A MIN. 36" DEEP LANDING ON EACH SIDE OF EACH EXTERIOR DOOR. EACH LANDING SHALL HAVE A DIMENSION OF NOT LESS THAN 36 INCHES MEASURED IN THE DIRECTION OF TRAVEL. THE SLOPE AT EXTERIOR LANDINGS SHALL NOT EXCEED 2%. LANDINGS OR FINISHED FLOORS AT THE REQUIRED EGRESS DOOR SHALL NOT BE MORE THAN 1/2" LOWER THAN THE TOP OF THE THRESHOLD, EXCEPT ON THE EXTERIOR SIDE SHALL NOT BE MORE THAN 3/4" BELOW THE TOP OF THE THRESHOLD PROVIDED THE DOOR DOES NOT SWING OVER THE LANDING OR FLOOR. ALL OTHER EXTERIOR DOORS SHALL BE PROVIDED WITH LANDING NOT MORE THAN 3/4" BELOW THE TOP OF THE THRESHOLD.

STAIR RAILING AND GUARDRAIL NOTES:

- STAIRWAYS SHALL HAVE A MINIMUM WIDTH OF 36". HAND RAILS MAY ENROACH A MAXIMUM OF 3/2" INTO THE REQUIRED WIDTH.

- ENCLOSED ACCESSIBLE SPACE UNDER STAIRS SHALL HAVE WALLS UNDER STAIR SURFACE AND ANY BOFFITS PROTECTED ON THE ENCLOSED SIDE WITH 1/2-INCH GYPSUM BOARD, PER R302.1 OF 2016 CRC.

- TREADS SHALL HAVE A MINIMUM LENGTH OF 10".
- RISERS SHALL BE A MAXIMUM OF 7 1/4".

- A NOSING NOT LESS THAN 0.75" BUT NOT MORE THAN 1.25" SHALL BE PROVIDED ON STAIRWAYS WITH SOLID RISERS WHERE THE TREAD DEPTH IS LESS THAN 11".

- TOLERANCE LARGEST AND SMALLEST RISER HEIGHT OR TREAD DEPTH SHALL BE 0.315".
- STAIRWAYS SHALL HAVE A MINIMUM OF 6'-8" OF HEADROOM AT THE NOSE OF THE STAIR.

- STAIRWAYS HAVING LESS THAN 4 RISERS DO NOT REQUIRE A HAND RAIL.

- GUARDRAILS SHALL BE PROVIDED FOR AT PORCHES, DECKS, BALCONIES, STAIRWAYS AND LANDINGS WHERE THE ADJACENT SURFACE IS GREATER THAN 30" BELOW.

- HANDRAILS SHALL BE CONTINUOUS THE FULL LENGTH OF THE STAIRS.

- THE ENDS OF HANDRAILS SHALL RETURN TO WALL OR TERMINATE INTO A NEUEL FOOT OR SAFETY TERMINAL.

- GUARDRAILS SHALL BE AT NOT LESS THAN 42" IN HEIGHT, PER CRC R312.2

- GUARDS ON THE OPEN SIDES OF STAIRS OR SERVES AS A HANDRAIL, THE TOP OF THE GUARD SHALL HAVE A HEIGHT NOT LESS THAN 34" AND NO MORE THAN 38"

- REQUIRED GUARDS SHALL NOT HAVE OPENINGS FROM THE WALKING SURFACE TO THE REQUIRED GUARD HEIGHT THAT ALLOW PASSAGE OF A SPHERE 4" IN DIAMETER, (R312.3)

- THE TRIANGULAR OPENINGS AT THE OPEN SIDE OF A STAIR FORMED BY THE RISER, TREAD, AND BOTTOM RAIL OF A GUARD, SHALL NOT ALLOW PASSAGE OF A SPHERE 6" IN DIAMETER. (R312.3 exception #)

- TYPE 1 HANDRAILS WITH A CIRCULAR CROSS SECTION SHALL HAVE AN OUTSIDE DIAMETER OF NOT LESS THAN 1 1/4" AND NOT GREATER THAN 2". IF THE HANDRAIL IS NOT CIRCULAR, IT SHALL HAVE A PERIMETER DIMENSION OF NOT LESS THAN 4" AND NOT GREATER THAN 6 1/4" WITH A CROSS SECTION DIMENSION OF NOT MORE THAN 2 1/4". EDGES SHALL HAVE A RADIUS OF NOT LESS THAN 0.20". TYPE 2 HANDRAILS WITH A PERIMETER GREATER THAN 6 1/4" SHALL HAVE A GRASP ABLE FINGER RECESS AREA ON BOTH SIDES OF THE PROFILE. THE FINGER RECESS SHALL BEGIN WITHIN A DISTANCE OF 3/4" MEASURED VERTICALLY FROM THE TALLEST PORTION OF THE PROFILE AND ACHIEVE A DEPTH OF NOT LESS THAN 5/16" WITHIN 1/8" BELOW THE WIDEST PORTION OF THE PROFILE. THIS REQUIRED DEPTH SHALL CONTINUE FOR NOT LESS THAN 3/8" TO A LEVEL THAT IS NOT LESS THAN 1/4" BELOW THE TALLEST PORTION OF THE PROFILE. THE WIDTH OF THE HANDRAIL ABOVE THE RECESS SHALL BE NOT LESS THAN 1/4" AND NOT MORE THAN 2 3/4". EDGES SHALL HAVE A RADIUS OF NOT LESS THAN 0.20".

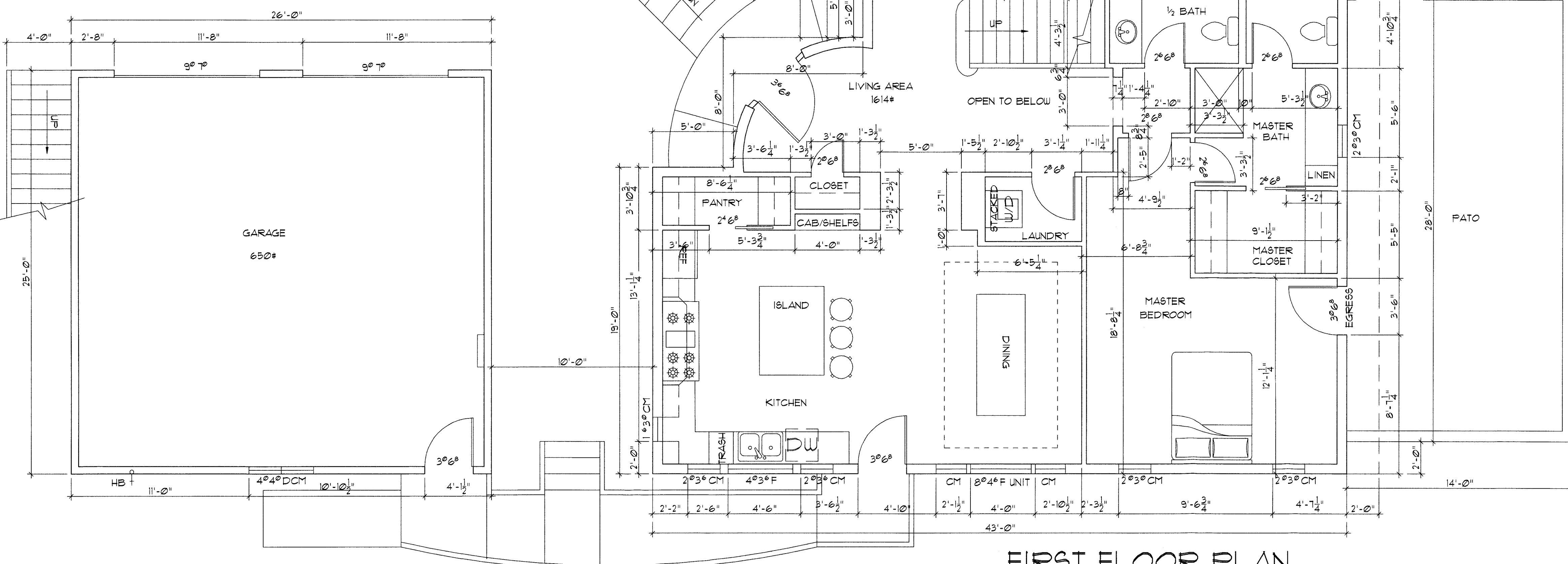

FIRST FLOOR PLAN

SCALE: 1/4" = 1'-0"

CALGREEN MANDATORY MEASURES

1. DUCT SYSTEMS ARE SIZED, DESIGNED, AND EQUIPMENT IS SELECTED PER SECTION 4507.2 HVAC SYSTEM INSTALLERS MUST BE TRAINED AND CERTIFIED AND SPECIAL INSPECTORS EMPLOYED BY THE ENFORCING AGENCY MUST BE QUALIFIED.
2. PROTECT ANNULAR SPACES AROUND PIPES, ELECTRIC CABLES, CONDUITS AT EXTERIOR WALLS AGAINST THE PASSAGE OF RODENTS (4.406.1)
3. COVER DUCT OPENINGS AND OTHER RELATED AIR DISTRIBUTION COMPONENT OPENINGS DURING CONSTRUCTION (4.504.1)
4. ADHESIVES, SEALANTS AND CAULKS SHALL BE COMPLIANT WITH VOC LIMITS AND OTHER TOXIC COMPOUNDS DURING CONSTRUCTION (4.504.2.1)
5. PAINTS, STAINS AND OTHER COATING SHALL BE COMPLIANT WITH VOC LIMITS (4.504.2.2)
6. AEROSOL PAINTS AND COATINGS SHALL BE COMPLIANT WITH PRODUCT WEIGHTED MIR LIMITS FOR ROC AND OTHER TOXIC COMPOUNDS (4.504.2.3) DOCUMENTATIONS SHALL BE PROVIDED TO VERIFY COMPLIANCE
7. CARPET AND CARPET SYSTEMS SHALL BE COMPLIANT WITH VOC LIMITS (4.504.3)
8. MINIMUM 80% OF FLOOR AREA RECEIVING RESILIENT FLOORING SHALL COMPLY WITH THE VOC-EMISSION LIMITS PER SECTIONS 4.504.4
9. PARTICLEBOARD, MEDIUM DENSITY FIBERBOARD (MDF) AND HARDWOOD PLYWOOD USED IN INTERIOR FINISH SYSTEM SHALL COMPLY WITH LOW FORMALDEHYDE EMISSION STANDARDS (4.504.5)
10. INSTALL CAPILLARY BREAK AND VAPOR RETARDER AT SLAB ON GRADE FOUNDATIONS (4.505.2)
11. CHECK MOISTURE CONTENT OF BUILDING MATERIALS USED IN WALL AND FLOOR FRAMING BEFORE ENCLOSURE (4.505.3)
12. PROVIDE A COPY OF THE OPERATION AND MAINTENANCE MANUAL TO THE BUILDING OCCUPANT OR OWNER ADDRESSING ITEMS 1 THROUGH 10 IN SECTION 4.410.1 BELOW.

SECTION 4.410.1 OPERATION AND MAINTENANCE MANUAL

AT THE TIME OF INSPECTION, A MANUAL, COMPACT DISC, WEB-BASED REFERENCE OR OTHER MEDIA ACCEPTABLE TO THE ENFORCING AGENCY WHICH INCLUDES ALL OF THE FOLLOWING SHALL BE PLACED IN THE BUILDING:

1. DIRECTIONS TO THE OWNER OR OCCUPANT THAT THE MANUAL SHALL REMAIN WITH THE BUILDING THROUGHOUT THE LIFE CYCLE OF THE STRUCTURE.
2. OPERATION AND MAINTENANCE INSTRUCTIONS FOR THE FOLLOWING:
 - a. EQUIPMENT AND APPLIANCES, INCLUDING WATER-SAVING DEVICES AND SYSTEMS, HVAC SYSTEMS, PHOTOVOLTAIC SYSTEMS, ELECTRICAL VEHICLE CHARGERS, WATER-HEATING SYSTEMS AND OTHER MAJOR APPLIANCES AND EQUIPMENT.
 - b. ROOF AND YARD DRAINAGE, INCLUDING GUTTERS AND DOWNSPOUTS.
 - c. SPACE CONDITIONING SYSTEMS, INCLUDING CONDENSERS AND AIR FILTERS.
 - d. LANDSCAPE IRRIGATION SYSTEMS.
 - e. WATER REUSE SYSTEMS.
3. INFORMATION FROM LOCAL UTILITY, WATER AND WASTE RECOVERY PROVIDERS ON METHODS TO FURTHER REDUCE RESOURCE CONSUMPTION, INCLUDING RECYCLE PROGRAMS LOCATIONS.
4. PUBLIC TRANSPORTATION AND/OR CARPOOL OPTIONS AVAILABLE IN THE AREA.
5. EDUCATIONAL MATERIAL ON THE POSITIVE IMPACTS OF AN INTERIOR RELATIVE HUMIDITY BETWEEN 30-60 PERCENT AND WHAT METHODS AN OCCUPANT MAY USE TO MAINTAIN THE RELATIVE HUMIDITY LEVEL IN THAT RANGE.
6. INFORMATION ABOUT WATER-CONSERVING LANDSCAPE AND IRRIGATION DESIGN AND CONTROLLERS WHICH CONSERVE WATER.
7. INSTRUCTIONS FOR MAINTAINING GUTTERS AND DOWNSPOUTS AND THE IMPORTANCE OF DIVERTING WATER AT LEAST 5 FEET AWAY FROM THE FOUNDATION.
8. INFORMATION ON REQUIRED ROUTINE MAINTENANCE MEASURES, INCLUDING, BUT NOT LIMITED TO CAULKING, PAINTING, GRADING AROUND THE BUILDING, ETC.
9. INFORMATION ABOUT STATE SOLAR ENERGY AND INCENTIVE PROGRAMS AVAILABLE.
10. A COPY OF ALL SPECIAL INSPECTION VERIFICATIONS BY THE ENFORCING AGENCY OR THIS CODE.

FIRST FLOOR AREA	1614#
SECOND FLOOR AREA	952#
SECOND FLOOR AREA OVER GARAGE	650#
TOTAL LIVING AREA :	3216#
GARAGE AREA	650#
2ND FLOOR COVERED DECK	109#
TOTAL FLOOR AREA:	3975#

VENTILATION

SEE SHEET AI-21

FOR SECOND FLOOR PLAN - SEE SHEET AI-12
FOR ELECTRICAL PLAN - SEE SHEET EI-11

SUE TAYLOR DESIGN
SUE TAYLOR BUILDING DESIGNER

P.O. BOX 361
CAMINO, CA 95109
(530) 391-2190
suetaylor@comcast.net

**NEW RESIDENCE
FIRST FLOOR PLAN**

**RANDY RALSTON & LINDA MENDIOLA
HERMOSA AVENUE
HALF MOON BAY, CA 94019**

REVISION	DATE	DESCRIPTION
1	4-7-19	REVISED PER COUNTY FIRE 3-3-19
2	4-7-19	REVISED PER PLANNING 3-19-19
3	6-21-19	REVISED PER DESIGN REVIEW 6-13-19
4	7-24-19	REVISED PER DESIGN REVIEW 7-11-19

Sue Taylor

DATE: FEBRUARY 07, 2019

DESIGNED BY: SRT
DRAWN BY: SRT
CHECKED BY: SRT

FILE # PROJECTS/2019/001/001/001
PROJECT # 18021

PAGE 6 OF 11

SHEET NO. AI-1.1

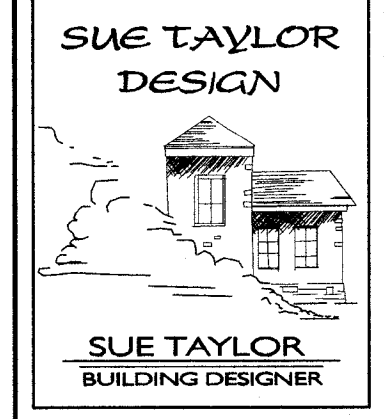

P.O. BOX 361
CAMINO, CA 95109
(530) 391-2190
suetaylor@comcast.net

NEW RESIDENCE
SECOND FLOOR PLAN

RANDY RALSTON & LINDA MENDIOLA
HERMOSA AVENUE
HALF MOON BAY, CA 94019

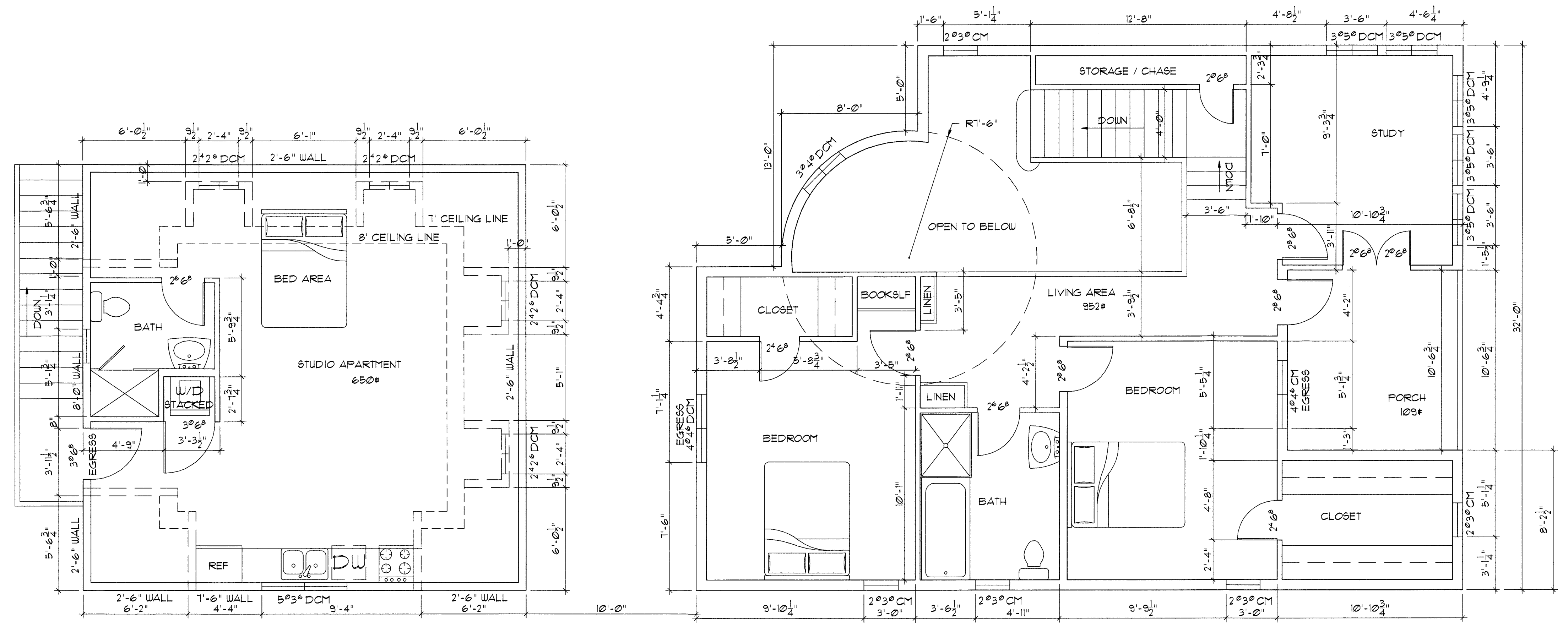

SECOND FLOOR PLAN

SCALE: 1/4" = 1'-0"

REVISION	DATE	DESCRIPTION
1	6-21-19	REVISIONS PER DESIGN REVIEW 6-13-19
2	1-24-19	REVISIONS PER DESIGN REVIEW 1-11-19

Sue Taylor

DATE:
FEBRUARY 07, 2019

DESIGNED BY: BRT
DRAWN BY: BRT
CHECKED BY: BRT

FILE #
PROJECTS/2019/001/001A12

PAGE 7 OF 11

SHEET NO.
A1-1.2

FOR FIRST FLOOR PLAN AND NOTES - SEE SHEET A1-1.1
FOR ELECTRICAL PLAN - SEE SHEET E1-1.2



EAST ELEVATION
RESIDENCE

SCALE: 1/4" = 1'-0"

ELEVATION COLORS:
ROOFING MATERIAL:
 COMPANY - KO, MATERIAL NAME - WESTERN REDWOOD
STUCCO COLOR:
 BENJAMIN MOORE "SMOKEY TAUPE" #383
WINDOWS AND ALL DOORS EXCEPT FRONT DOOR:
 BENJAMIN MOORE "KENSINGTON BLUE" #840
WOOD TRIM:
 BENJAMIN MOORE "ROOKIES BROWN" #2107-30
FRONT DOOR:
 CLEAR WOOD WITH VARNISH

VENTILATION

UNDER FLOOR SPACES SHALL HAVE VENTILATION EQUAL TO ONE SQUARE FOOT PER 150 SQUARE FEET OF FLOOR SPACE. VENTS SHALL BE COVERED WITH GALVANIZED WIRE SCREEN WITH 1/4" OPENINGS. VENTS SHALL BE LOCATED TO PROVIDE CROSS VENTILATION.
 NECESSARY UNDER FLOOR VENTING:
 1614# OF UNDER FLOOR / 150# = MIN. 1076# OF VENTILATION NECESSARY.
 INSTALL MIN. OF 16 - 8" x 16" (10#) SCREENED VENTS = 112#
 PLACE UNIFORMLY AROUND PERIMETER
 GARAGES SHALL BE VENTED WITH 60 SQUARE INCHES PER CAR LOCATED 6" ABOVE THE FLOOR SURFACE. COVER WITH GALVANIZED WIRE SCREEN WITH 1/4" OPENINGS.
 2 - 6"x14" (52 sq. in) SCREENED GARAGE VENT - 104 SQ. IN.

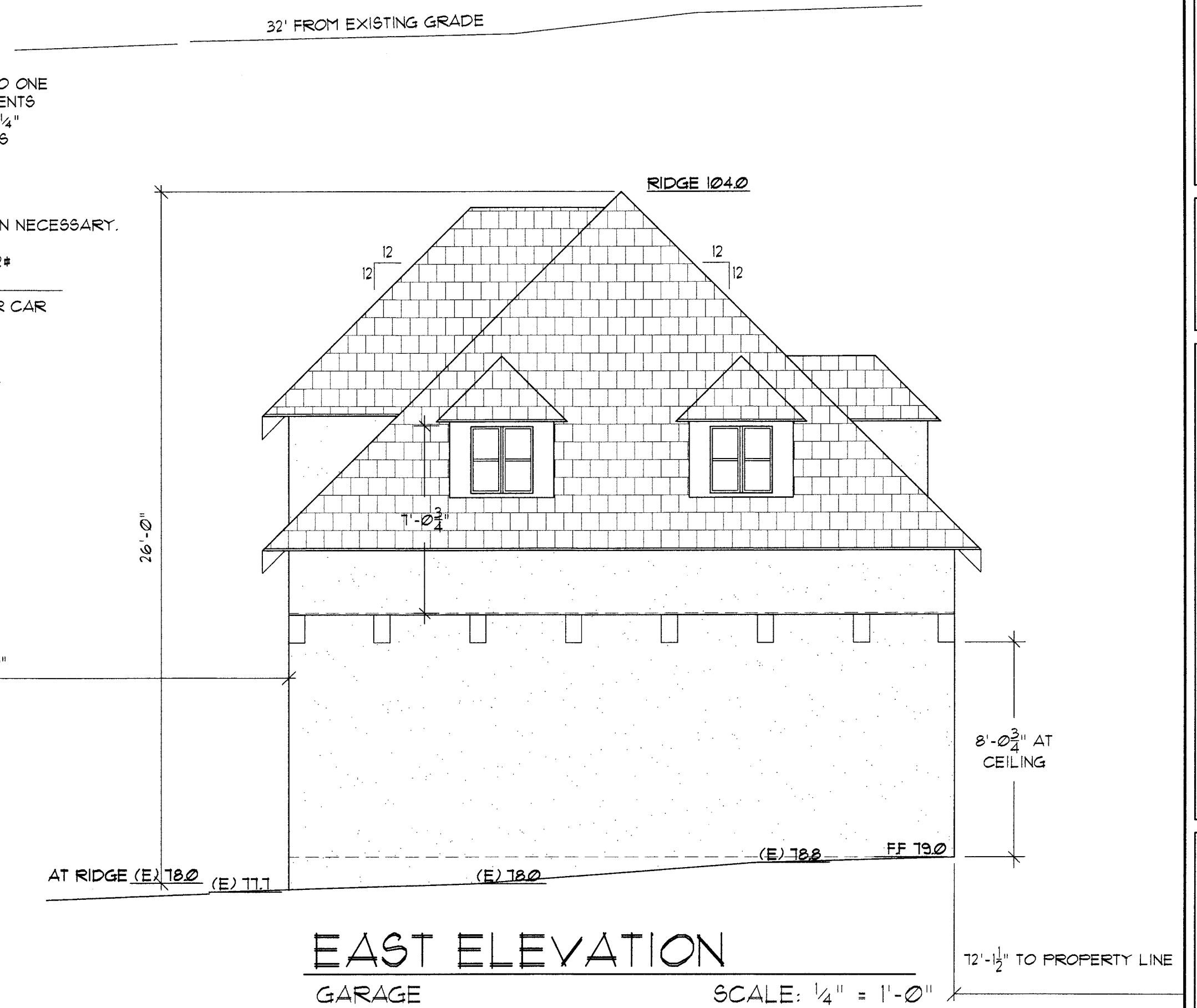

EAST ELEVATION
GARAGE

SCALE: 1/4" = 1'-0"



WEST ELEVATION
RESIDENCE

SCALE: 1/4" = 1'-0"

FF. = 93.15

FF. = 83.0

ROOF VENTILATION

PER CRC SECTION R802.1: ENCLOSED ATTICS AND ENCLOSED RAFTER SPACES FORMED WHERE CEILINGS ARE APPLIED DIRECTLY TO THE UNDERSIDE OF ROOF RAFTERS SHALL HAVE CROSS VENTILATION FOR EACH SEPARATE SPACE BY VENTILATING OPENINGS PROTECTED AGAINST THE ENTRANCE OF RAIN OR SNOW. VENTILATION OPENINGS SHALL HAVE A LEAST DIMENSION OF 1/16-INCH AND 1/4-INCH MAX. OPENINGS IN ROOF FRAMING MEMBERS SHALL CONFORM TO THE REQUIREMENTS OF SECTION R802.1.
 PER CRC SECTION R802.2: THE TOTAL NET FREE VENTILATING AREA SHALL NOT BE LESS THAN 1/150 OF THE AREA OF THE SPACE VENTILATED EXCEPT THAT REDUCTION OF THE TOTAL AREA TO 1/300 IS PERMITTED PROVIDED THAT AT LEAST 40 PERCENT AND NOT MORE THAN 80 PERCENT OF THE REQUIRED VENTILATION AREA IS PROVIDED BY VENTILATORS LOCATED IN THE UPPER PORTION OF THE SPACE TO BE VENTILATED AT LEAST 3 FEET ABOVE THE EAVE OR CORNICE VENTS WITH THE BALANCE OF THE REQUIRED VENTILATION PROVIDED BY EAVE OR CORNICE VENTS. AS AN ALTERNATIVE, THE NET FREE CROSS-VENTILATION AREA MAY BE REDUCED TO 1/300 WHEN A CLASS I OR II VAPOUR BARRIER IS INSTALLED ON THE WARM-IN-WINTER SIDE OF THE CEILING.
 PER CRC SECTION R802.3: WHERE EAVE OR CORNICE VENTS ARE INSTALLED, INSULATION SHALL NOT BLOCK THE FREE FLOW OF AIR. A MINIMUM OF A 1-INCH SPACE SHALL BE PROVIDED BETWEEN THE INSULATION AND THE ROOF SHEATHING AND AT THE LOCATION OF THE VENT.

NECESSARY LOWER ROOF VENTILATION:
 ROOF: 378# / 150 = 252# OF VENTILATION NECESSARY

PROPOSED LOWER ROOF VENTILATION:
 ROOF: 20 L.F. OF RIDGE VENT (.125 PER SQ. FT.) = 2.5
 ON EAST SIDE: 10 (TOTAL) - BAY VENTS (.13 PER BAY#) = 13#
 ON WEST SIDE: 10 (TOTAL) - BAY VENTS (.13 PER BAY#) = 13#
 TOTAL PROPOSED LOWER ROOF: 5.18

NECESSARY UPPER ROOF VENTILATION:
 ROOF: 1323# / 150 = 882# OF VENTILATION NECESSARY

ROOF: 112# / 150 = .75# OF VENTILATION NECESSARY

NECESSARY GARAGE ROOF VENTILATION:
 ROOF: 650# / 150 = 4.33# OF VENTILATION NECESSARY

PROPOSED GARAGE ROOF: 2.75
 ROOF: 112# / 150 = .75# OF VENTILATION NECESSARY

PROPOSED GARAGE ROOF: 2.75

ROOF NOTES:

1. ROOF COVERING AND ASSOCIATED MATERIALS SHALL HAVE A MIN. FIRE RATING OF CLASS "B" AS DEFINED IN THE CRC, SMC ORDINANCE SECTION 23.07.020.

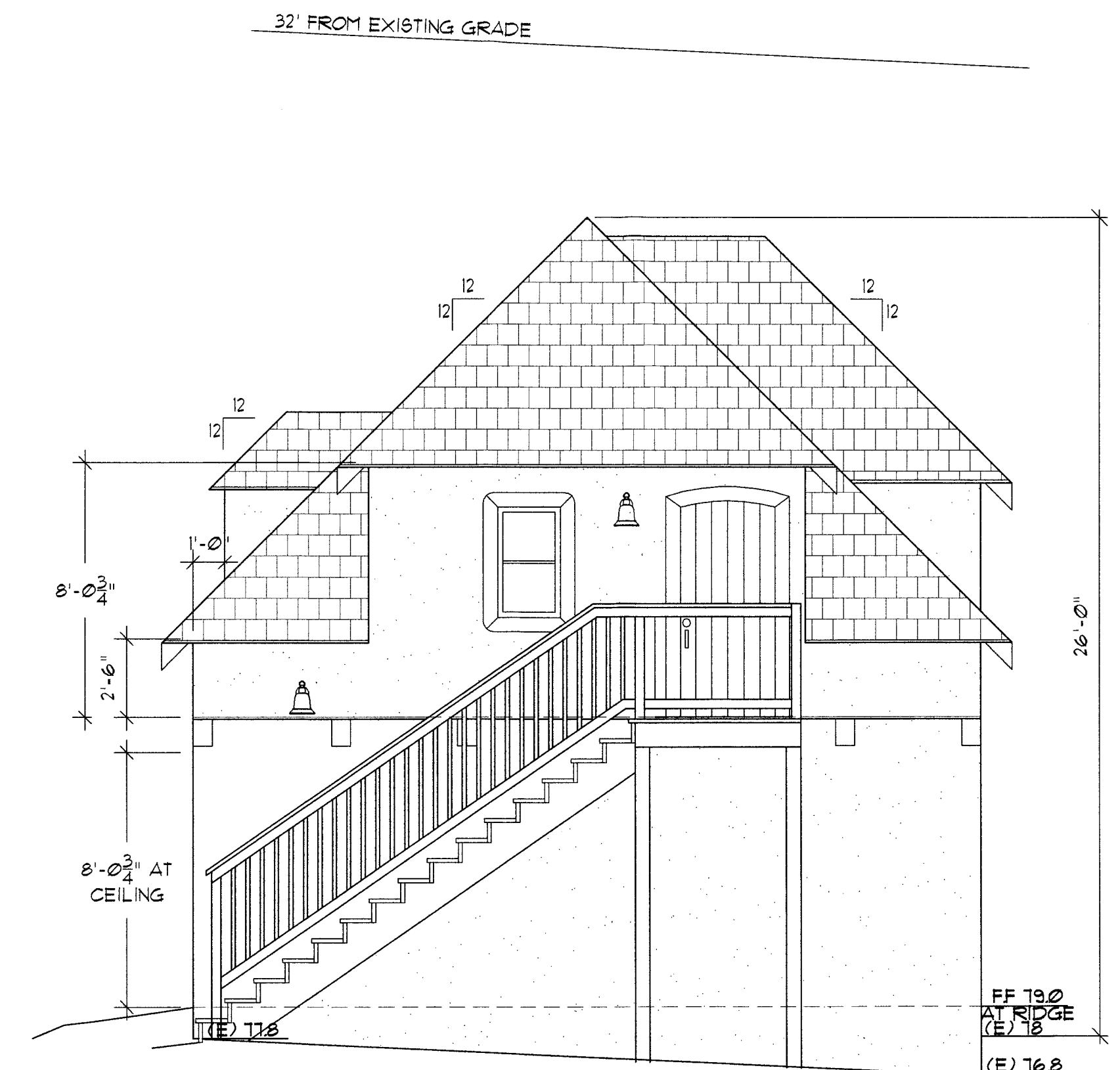

WEST ELEVATION
GARAGE

SCALE: 1/4" = 1'-0"

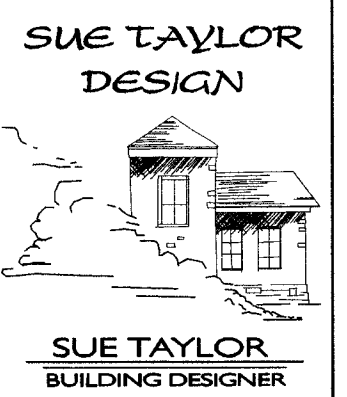

P.O. BOX 861
 CAMINO, CA 95109
 (530) 281-2190
 suetaylor@comcast.net

NEW RESIDENCE
 EAST & WEST
 ELEVATIONS

RANDY RALSTON & LINDA MENDIOLA
 HERMOSA AVENUE
 HALF MOON BAY, CA 94019

REVISION	DATE	DESCRIPTION
1	4-2-19	REVISIONS PER COUNTY FIRE 3-2-19
2	4-2-19	REVISIONS PER PLANNING 3-9-19
3	6-21-19	REVISIONS PER DESIGN REVIEW 6-13-19
4	7-24-19	REVISIONS PER DESIGN REVIEW 7-11-19

Sue Taylor

DATE: FEBRUARY 07, 2019

DESIGNED BY: BRT
 DRAWN BY: BRT
 CHECKED BY: BRT

FILE # PROJECTS/2019/001/001A21
 PROJECT # 18001

PAGE 8 OF 11

SHEET NO. A1-2.1

IN NO CASE SHOULD THE AMOUNT OF EXHAUST VENTILATION EXCEED THE AMOUNT OF INTAKE VENTILATION.

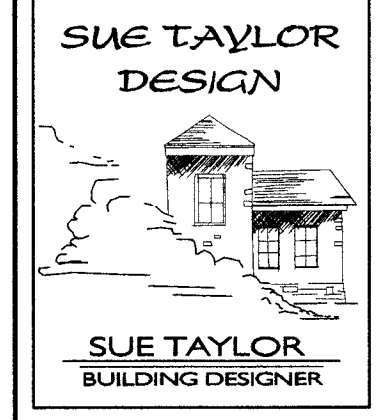

P.O. BOX 361
CAMINO, CA 95109
(530) 391-2190
suetaylordesign@comcast.net

NEW RESIDENCE
NORTH & SOUTH
ELEVATIONS

RANDY RALSTON & LINDA MENDIOLA
HERMOSA AVENUE
HALF MOON BAY, CA 94019

REVISION	DATE	DESCRIPTION
1	4-2-19	REVISIONS PER PLANNING 3-16-19
2	6-21-19	REVISIONS PER DESIGN REVIEW 6-13-19
3	1-24-19	REVISIONS PER DESIGN REVIEW 1-11-19

Sue Taylor

DATE:
FEBRUARY 07, 2019

DESIGNED BY: BRT
DRAWN BY: BRT
CHECKED BY: BRT

FILE #
PROJECTS\2019\001\001\022
PROJECT #
18001

PAGE
9 OF
11

SHEET NO.
A1-2.2

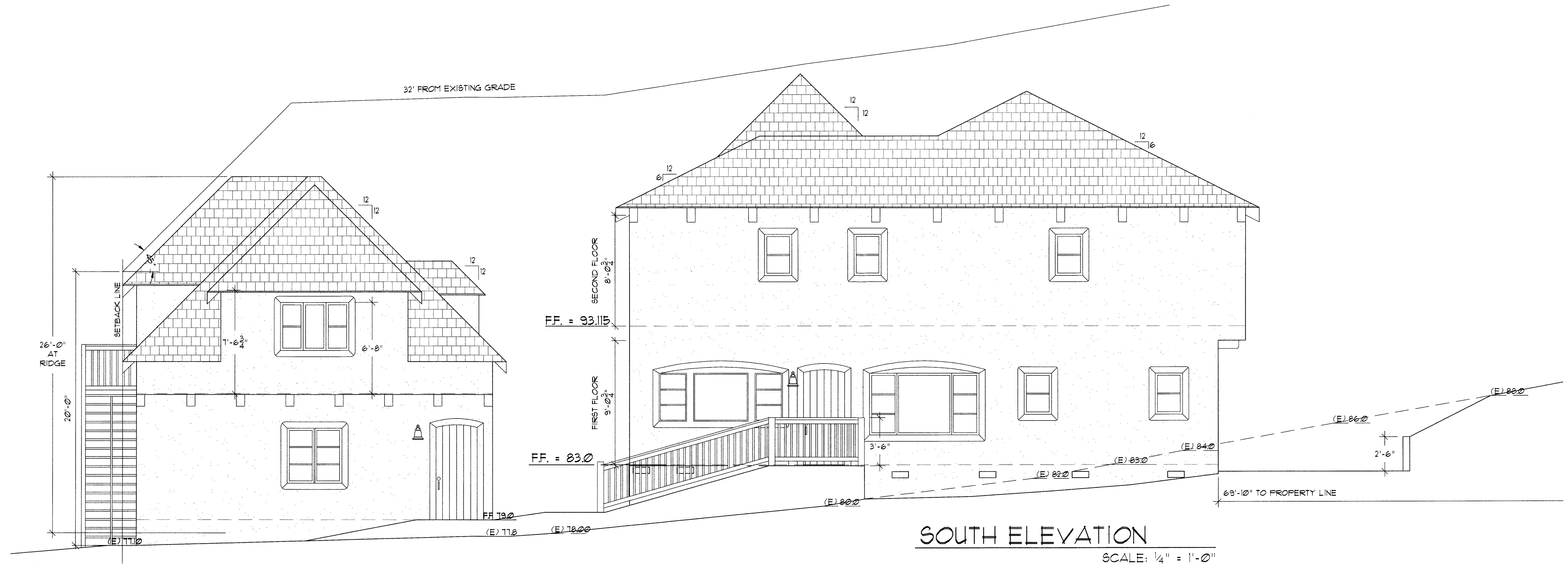
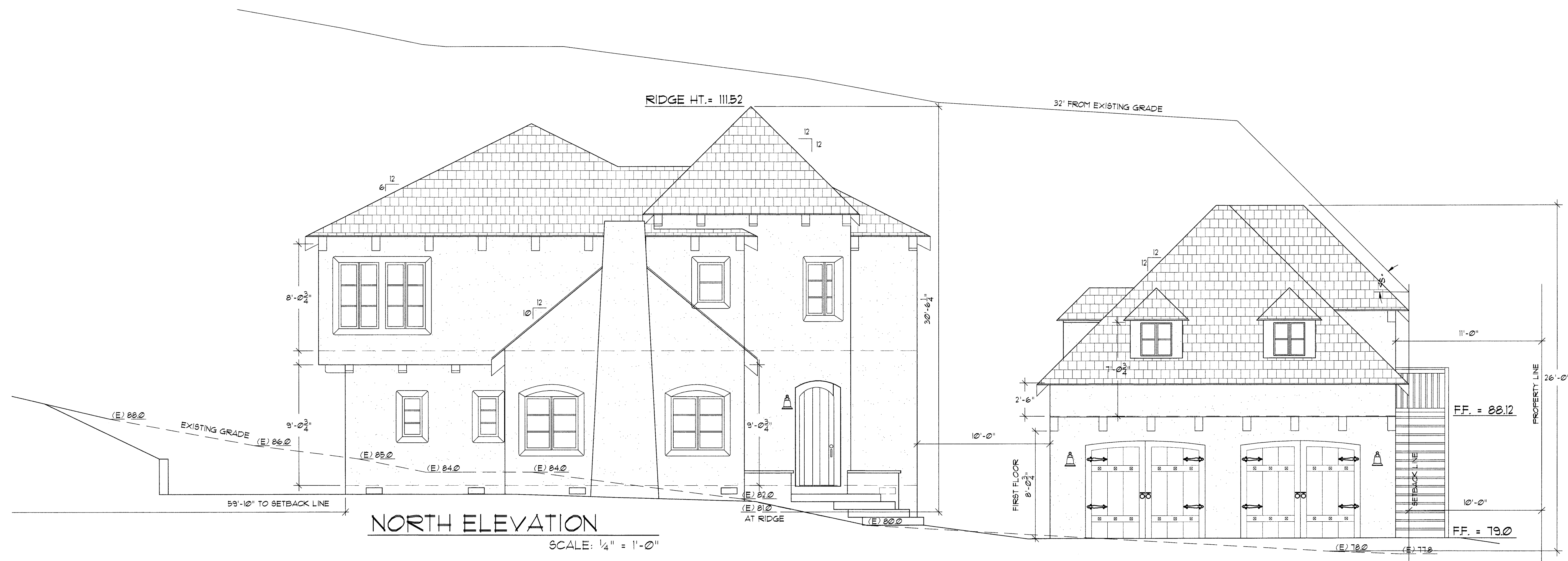

REVISION	DATE	DESCRIPTION
1	4-2-19	NEVISIONS PER PLANNING 3-18-19
2	6-21-19	NEVISIONS PER DESIGN REVIEW 6-13-19
3	7-24-19	NEVISIONS PER DESIGN REVIEW 7-11-19

Sue Taylor

DATE:
FEBRUARY 07, 2019

DESIGNED BY: BRT
DRAWN BY: BRT
CHECKED BY: BRT

FILE #
PROJECTS/2019/001001431

PROJECT #
180071

PAGE
10 OF
11

SHEET NO.
A1-3.1

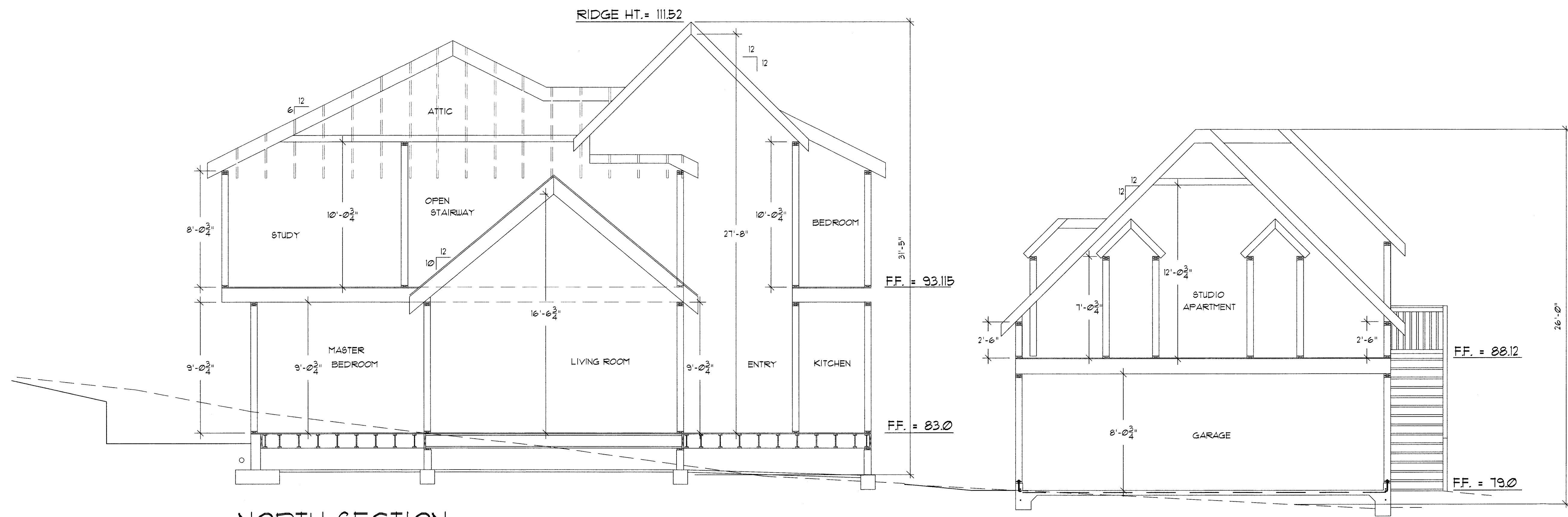

NORTH SECTION

SCALE: 1/4" = 1'-0"

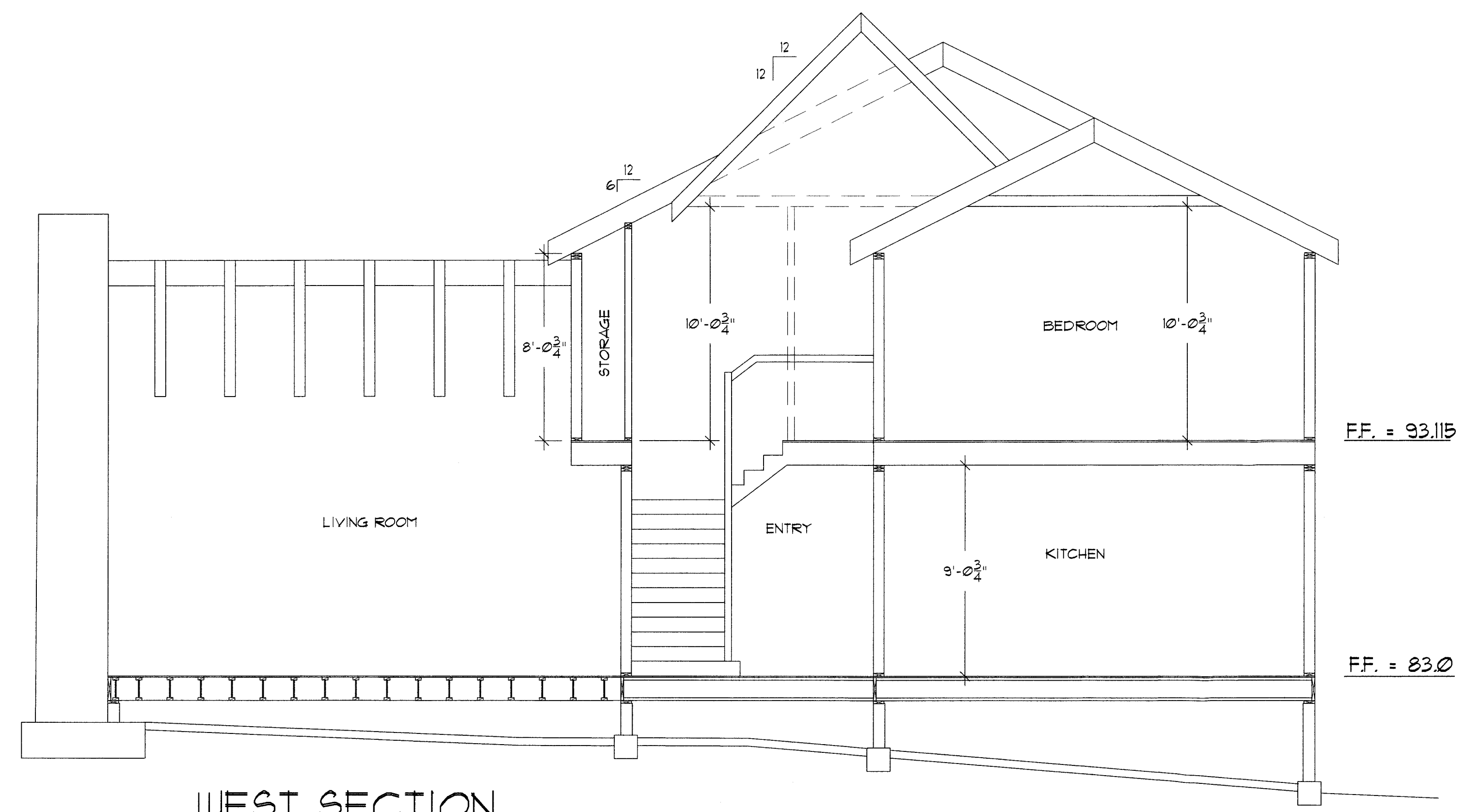

WEST SECTION

SCALE: 1/4" = 1'-0"

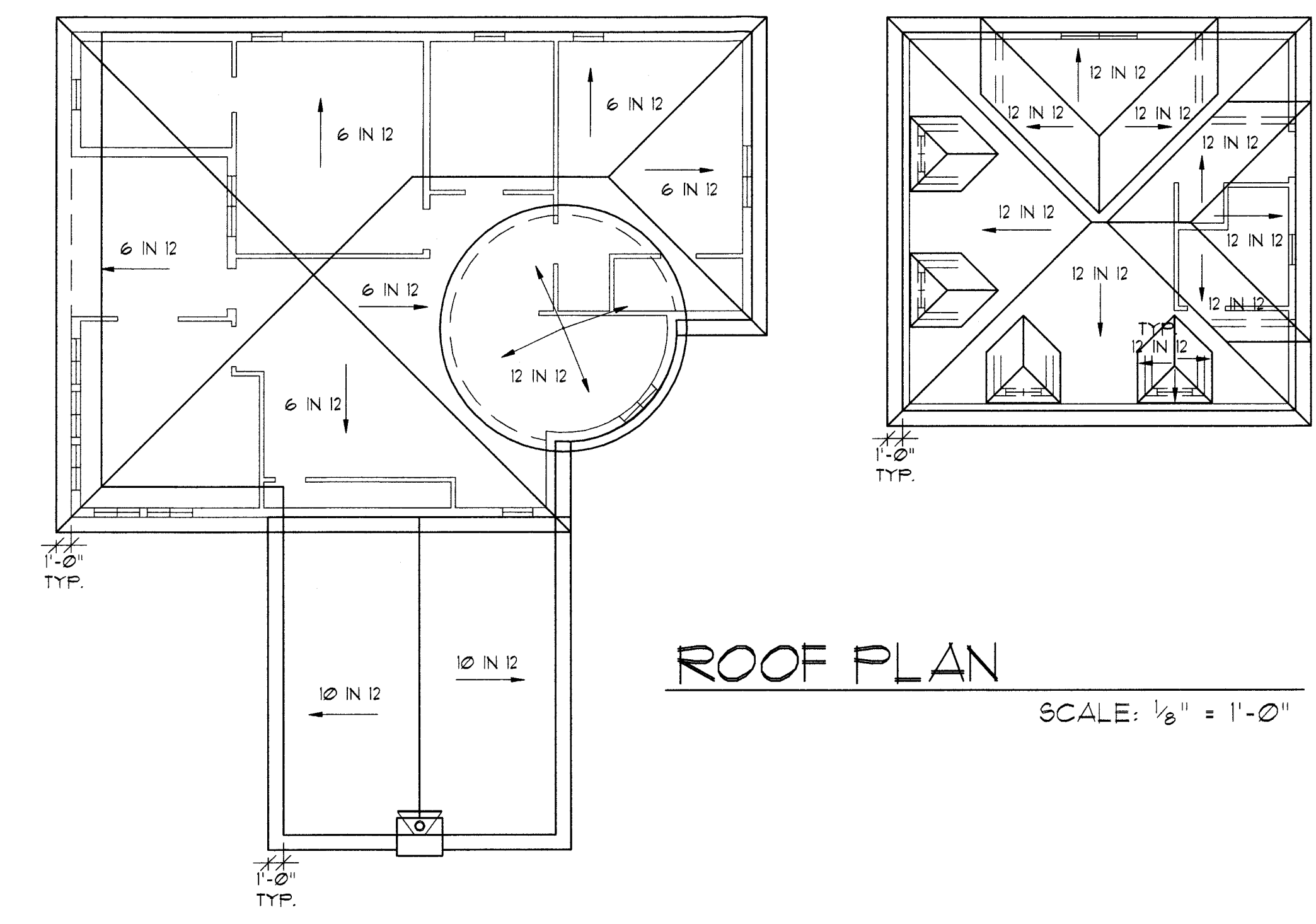

ROOF PLAN

SCALE: 1/8" = 1'-0"

FIRE JURISDICTION: <input type="checkbox"/> BELMONT FIRE <input checked="" type="checkbox"/> COASTSIDE FIRE <input type="checkbox"/> SM COUNTY FIRE <input type="checkbox"/> WOODSIDE FIRE	San Mateo County Building Dept. 2013 CRC –R327 Development Worksheet Materials and Construction Methods for Exterior Wildfire Exposure
---	---

Project is located in State Responsibility Area (SRA): Yes No
 If in SRA, is project in a Very High Fire Hazard Severity Zone (VHFHSZ): Yes No

Project is located in Local Responsibility Area (LRA): Yes No
 If in LRA, is project in a Very High Fire Hazard Severity Zone (VHFHSZ): Yes No

Applicable Code Section(s)	OK	N/A	Approved Material (if applicable)	Location On Plans
Roofing				
Class B minimum (SM Co Div VII, Sec 9113; 2013 CRC R902.1.2)	X		Armourshake, Premium Dimensional IKO Shingles - Western Redwood	007A121
Class A in VHFHSZ (2013 CRC R902.1.1)		X		
Where roof profile allows for a space between the roof covering and deck, the spaces shall be constructed to prevent the intrusion of flames and embers, fire stopped or have one layer of No. 72 ASTM D 3909 cap sheet over the combustible decking. (R327.5.2)	X			007A121
Valley flashings min. 0.019-inch (No 26 galv.) corrosion resistant metal over 36 inch wide underlayment of No. 72 lb mineral-surfaced nonperforated ASTM D 3909 cap sheet. (R327.5.3)	X			007A121
Roof gutters shall be provided with the means to prevent the accumulation of debris. (R327.5.4)	X			007A121

Applicable Code Section(s)	OK	N/A	Approved Material (if applicable)	Location On Plans
Vents				
Ventilation openings for attics, enclosed eave soffits, enclosed rafter spaces and underfloor areas shall be non-combustible, corrosion resistant, and have wire mesh with 1/16" to 1/8" inch (1.6-3.2 mm) openings or its equivalent. (R327.6.2)	X			007A121

Applicable Code Section(s)	OK	N/A	Approved Material (if applicable)	Location On Plans
Eave Vents				
Vents shall not be installed in eaves and cornices. Exceptions: 1. Approved flame and ember resistant vents. 2.1 Attic is fully protected by an automatic fire sprinkler system, and 2.2 Exterior wall and underside of eave is non-combustible, and is more than 12 ft from ground, patio, porch, deck or similar surface. (R327.6.3)	X			007A121

Applicable Code Section(s)	OK	N/A	Approved Material (if applicable)	Location On Plans
Exterior Coverings				
Exterior walls shall comply with one of the following (R327.7.3): 1. Noncombustible material 2. Ignition-resistant material 3. One layer of 5/8" type X gypsum sheathing behind exterior covering. 4. 1-hour fire resistant exterior assembly. 5. Heavy-timber exterior wall assembly 6. Log wall construction. 7. Wall assemblies meeting SFM 12-7A-1	X			007A121
Open Roof Eaves: The exposed roof deck on the underside of the roof eave shall comply with one of 1 through 4 as for exterior walls above (R327.7.4). Ex: 1. 2" nominal solid wood rafter tails. 2. 2" nominal solid wood blocking between rafter tails. 3. Fascia and other architectural trim boards.	X			007A121

Applicable Code Section(s)	OK	N/A	Approved Material (if applicable)	Location On Plans
Exterior Coverings (continued)				
The exposed underside of enclosed roof eaves and roof eave soffits shall be protected by one of the 1 through 4 items as for exterior walls or have boxed in soffits meeting SFM 7A-3 (R327.7.5). Ex: Fascia and other architectural trim boards.	X			007A121
Exterior porch ceilings shall be protected by one of the 1 through 4 items as for exterior walls or have porch ceiling assemblies meeting SFM 7A-3 (R327.7.6). Ex: Architectural trim boards.	X			007A121
Exposed underside of floor projections shall be protected by one of the 1 through 4 items as for exterior walls or have an underside assembly meeting SFM 7A-3 (R327.7.7). Ex: Architectural trim boards.	X			007A121
The underfloor area of overhangs, or elevated buildings, and underside of appendages shall be enclosed to grade or the underside shall be protected by one of the 1 through 4 items as for exterior walls or have an assembly meeting SFM 7A-3 (R327.7.8 & R327.7.9). Ex: Heavy-timber structural columns and beams do not require protection.	X			007A121

Applicable Code Section(s)	OK	N/A	Approved Material (if applicable)	Location On Plans
Exterior Glazing				
Exterior windows, glazed doors, glazed openings within exterior doors and structural glass veneer shall be constructed of one of the following: Note - Provide on window schedule and call out on floor plan. (R327.8.2) 1. Multipane glass units with a minimum of one tempered pane meeting Section 2406 Safety Glazing. 2. Glass block units. 3. 20 minute minimum Fire Rated Window. 4. Meet SFM 12-7A-2.	X			007A111

Applicable Code Section(s)	OK	N/A	Approved Material (if applicable)	Location On Plans
Doors				
Exterior door assemblies, including garage doors, shall comply with one of the following (R327.8.3): 1. Surface or cladding be of non-combustible, or ignition-resistant material. 2. Constructed of solid core wood having stiles and rails not less than 1-3/8" with interior field panel thickness no less than 1-1/4" thick. 3. Have a fire resistance rating of not less than 20 minutes. 4. Meet SFM 12-7A-1	X			007A111

Applicable Code Section(s)	OK	N/A	Approved Material (if applicable)	Location On Plans
Decking				
The walking surface material of decks, porches, balconies and stairs shall be constructed of one of the following where any portion of such surface is within 10 ft. of the structure (R327.9.3): 1. Ignition-resistant materials that complies with SFM 12-7A-4 and 12-7A-5. 2. Exterior fire-retardant-treated wood. 3. Noncombustible material. 4. Material complying with SFM 12-7A-4A when attached to a noncombustible or ignition resistant wall covering. Ex: When decking surface material meets ASTM E 84, Class B flame spread, the wall material can of any that other wise complies with R327.7.3.	X			007A111

Applicable Code Section(s)	OK	N/A	Approved Material (if applicable)	Location On Plans
Accessory Structure				
Trellises, arbors, patio covers, carports, gazebos and similar structures attached to applicable buildings and detached buildings within 50 ft shall be constructed of noncombustible or ignition resistant material. (R327.10)	X			007A111

Office of the State Fire Marshal – Building Materials Listing: http://osfm.fire.ca.gov/licensinglistings/licenselist_bml_searchcotest.php
 8110-Decking Materials, 8120-Exterior Windows, 8140-Exterior Siding & Sheathings, 8150-Exterior Doors, 8160-Under Eave

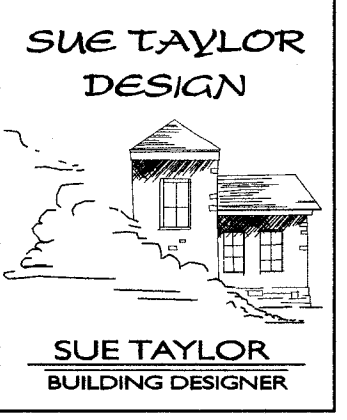

SUE TAYLOR
 BUILDING DESIGNER
 P.O. BOX 961
 CAMINO, CA 95709
 (930) 391-2190
 suetaylor@concast.net

NEW RESIDENCE
 COUNTY FIRE WORKSHEETS

RANDY RALSTON & LINDA MENDIOLA
 HERMOSA AVENUE
 HALF MOON BAY, CA 94019

REVISION	DATE	DESCRIPTION
1	4-7-19	REVISIONS PER COUNTY FIRE 3-3-19

Sue Taylor

DATE: FEBRUARY 07, 2019

DESIGNED BY: [BRT]
 DRAWN BY: [BRT]
 CHECKED BY: [BRT]

FILE # PROJECTS/2018/001/00711
 PROJECT # 18001

PAGE 11 OF 11

SHEET NO. 11 - 11