

GENERAL NOTES	ABBREVIATIONS																																																																																																																																																																																																																																																																																																																																																																																																																																																																																																																																																																																																																																																																																																																								
<p>GENERAL NOTES</p> <p>1- ALL WORK SHALL CONFORM TO LOCAL BUILDING CODES 2019 CALIFORNIA BUILDING CODE (CBC), 2019 CALIFORNIA RESIDENTIAL CODE (CRC), 2019 CALIFORNIA ELECTRICAL CODE (CEC), 2019 CALIFORNIA MECHANICAL CODE (CMC), 2019 CALIFORNIA PLUMBING CODE (CPC), 2019 CALIFORNIA ENERGY EFFICIENCY STANDARDS CODE (CES), 2019 CALIFORNIA FIRE CODE (FC), & 2019 CALIFORNIA GREEN BUILDING STANDARDS CODE (CGS OR CALGREEN), REGARDLESS OF WHAT IS SHOWN, OR NOT SHOWN, IN THE CONTRACT DOCUMENTS. THE CONTRACTOR SHALL COMPLY WITH ALL OTHER APPLICABLE STATE OR LOCAL ORDINANCES. IN THE EVENT OF A CONFLICT, THE MORE STRINGENT REQUIREMENT SHALL APPLY.</p> <p>2- ALL DIMENSIONS ARE TO FACE OF STUD, U.N.O. ALL DIMENSIONS MARKED "CLEAR" SHALL BE MAINTAINED AND SHALL ALLOW FOR THICKNESS OF ALL FINISHES INCLUDING GYPSUM BOARD, TRIM, CARPET, TILE, ETC.</p> <p>3- GRID LINES (IF SHOWN) ARE FOR REFERENCE ONLY AND DO NOT NECESSARILY IMPLY STRUCTURAL COLUMN CENTER LINES OR EXISTING EDGES.</p> <p>4- ALL SYSTEMS AND ASSEMBLIES SHALL BE FOR COMPLETE AND FULLY FUNCTIONAL OPERATION EVEN IF NOT FULLY DESCRIBED IN THE CONTRACT DOCUMENTS. IN THE EVENT CERTAIN FEATURES OF CONSTRUCTION ARE NOT FULLY SHOWN ON THE DRAWINGS, OR CALLED FOR IN THE SPECS, THEN THEIR CONSTRUCTION SHALL BE OF THE SAME CHARACTER OF SIMILAR CONDITIONS SHOWN OR CALLED FOR, OR SHALL BE INSTALLED PER ACCEPTED INDUSTRY STANDARDS.</p> <p>5- INSTALL ALL MATERIALS, EQUIPMENT, FIXTURES, APPLIANCES, AND ACCESSORIES IN CONFORMANCE WITH THE MANUFACTURER'S REQUIREMENTS AND RECOMMENDATIONS. VERIFY ALL SUCH REQUIREMENTS PRIOR TO STARTING THE WORK IN THE AREAS WHERE THEY OCCUR.</p> <p>6- ALL WORK SHALL BE INSTALLED PLUMB, LEVEL AND TRUE IN ACCORDANCE WITH THE CONTRACT DOCUMENTS.</p> <p>7- UNLESS OTHERWISE NOTED ALL CONNECTIONS SHALL BE CONCEALED, THE USE OF SURFACE FASTENERS SHALL BE APPROVED BY THE ARCHITECT. ALL EXTERIOR FASTENERS SHALL BE HOT DIPPED GALVANIZED OR STAINLESS STEEL.</p> <p>8- BEFORE REMOVING WALLS OR EXST. CONST. G.C. SHALL INSPECT EXST. FRAMING AND PROVIDE ADEQUATE TEMPORARY SHORING. G.C. SHALL NOTIFY ARCHITECT OF ANY LOAD BEARING CONSTRUCTION INDICATED TO BE REMOVED PRIOR TO PROCEEDING WITH DEMOLITION.</p> <p>9- SAFE TEMPORARY SHORING AND BRACING NECESSARY TO SUPPORT THE INCOMPLETE STRUCTURE IS THE CONTRACTOR'S RESPONSIBILITY.</p> <p>10- ALL NEW/ REPLACEMENT EXTERIOR DOORS SHALL BE FIRE RESISTIVE & RATED 20 MINUTES MINIMUM.</p> <p>11- MINIMUM HABITABLE ROOM IS 7' BY 7'</p> <p>12- MINIMUM HABITABLE ROOM HEIGHT IS 7'6"</p> <p>VERIFY CONDITIONS:</p> <p>13- THE GENERAL CONTRACTOR (G.C.) SHALL REVIEW ALL DOCUMENTS AND VERIFY DIMENSIONS AND FIELD CONDITIONS AND SHALL CONFIRM THAT WORK IS BUILDABLE AS SHOWN, ANY CONFLICTS OR OMISSIONS, ETC., SHALL BE IMMEDIATELY REPORTED TO THE ARCHITECT FOR CLARIFICATION PRIOR TO THE PERFORMANCE OF ANY WORK IN QUESTION. G.C. SHALL NOT PROCEED ON ASSUMPTIONS.</p> <p>14- THESE DRAWINGS MAY NOT BE TO SCALE AND ARE FOR ILLUSTRATION PURPOSES ONLY. THE CONTRACTOR SHALL FIELD VERIFY ALL DIMENSIONS, LAYOUTS AND EXISTING CONDITIONS PRIOR TO EXECUTING THE WORK.</p> <p>15- WRITTEN DIMENSIONS TAKE PRECEDENCE OVER GRAPHIC SCALE SHOWN. DIMENSIONS SHOULD NOT BE DETERMINED BY TAKING MEASUREMENTS FROM SCALED DRAWINGS. IF ADDITIONAL DIMENSIONS ARE NEEDED THEY SHOULD BE REQUESTED FROM THE ARCHITECT.</p> <p>16- DETAILS TAKE PRECEDENCE OVER SMALLER SCALE DRAWINGS.</p> <p>UTILITIES:</p> <p>17- G.C. SHALL NOTIFY THE ARCHITECT OF ANY EXISTING UTILITIES, NOT COVERED IN THE CONSTRUCTION / DEMOLITION DOCUMENTS, WHICH MAY INTERFERE WITH THE INSTALLATION/COMPLETION OF SCOPE OF WORK. THE G.C. SHALL DISCUSS THE REMOVAL OF THESE UTILITIES WITH THE ARCHITECT AND THE BUILDING INSPECTOR PRIOR TO PROCEEDING WITH WORK. WHEN REMOVAL IS APPROVED BY THE ARCHITECT AND THE BUILDING INSPECTOR, G.C. SHALL DISCONNECT THE SPECIFIED UTILITY, CUT BACK TO THE SOURCE, (OR PERIMETER OF PROJECT SITE) AND CAP. ALL BUILDING PENETRATIONS RESULTING FROM THIS REMOVAL OR THIS CONSTRUCTION SHALL BE SEALED WITH NEW CONSTRUCTION TO MATCH EXISTING BUILDING FINISHES.</p> <p>DISCREPANCIES:</p> <p>18- IN CASE OF DISCREPANCIES OR CONFLICTS IN INFORMATION OR REQUIREMENTS WITHIN SPECS, OR BETWEEN THE DRAWINGS AND SPECS, THE MOST EXPENSIVE REQUIREMENT SHOWN OR SPECIFIED SHALL BE THE BASIS OF THE CONTRACT FOR CONSTRUCTION.</p> <p>19- IN CASE OF CONFLICT BETWEEN ARCHITECT'S AND ENGINEER'S DRAWINGS IN LOCATING MATERIALS/EQUIPMENT, THE ARCHITECT SHALL BE NOTIFIED IMMEDIATELY FOR CLARIFICATION</p> <p>SAFETY & PROTECTION OF SITE:</p> <p>20- CONSTRUCTION METHODS: NEITHER THE ARCHITECT OR THE OWNER SHALL BE RESPONSIBLE FOR CONSTRUCTION MEANS, METHODS OR TECHNIQUES, SEQUENCES OR PROCEDURES OF THE CONTRACTOR. SAFETY PRECAUTIONS AND PROGRAMS OF THE CONTRACTOR OR FAILURE OF THE CONTRACTOR TO PERFORM THE WORK IN ACCORDANCE WITH THE CONTRACT DOCUMENTS.</p> <p>21- SITE CONDITIONS INCLUDING LANDSCAPING SHALL BE PROTECTED BY THE CONTRACTOR. SIGNIFICANT LANDSCAPING INCLUDING BUT NOT LIMITED TO ROOT SYSTEMS SHALL BE PROTECTED AND ARE NOT INTENDED TO BE DAMAGED, CUT, RELOCATED OR REMOVED UNLESS SPECIFIED IN DRAWINGS.</p> <p>22- CONTRACTOR TO VERIFY EXISTING CONDITIONS: PROTECT AND SECURE SITE, BUILDING, MATERIALS AND EQUIPMENT FROM THEFT, VANDALISM AND UNAUTHORIZED ENTRY. PROTECT EXISTING LANDSCAPING, WINDOWS, INTERIOR AND EXTERIOR WALLS AND DOORS FROM DAMAGE DURING CONSTRUCTION. PROTECT FINISHED FLOORS FROM DIRT, WEAR AND DAMAGE.</p> <p>WATER PROOFING:</p> <p>23- ALL PENETRATIONS SHALL BE SEALED FOR WATER TIGHT PERFORMANCE. INSTALL POLYURETHANE BASED SEALANT AT ALL PENETRATIONS AND JOINTS. FOR JOINTS LARGER THAN 1/2" SEALANT SHALL BE INSTALLED OVER APPROVED SOLID BACKER ROD.</p> <p>24- ARCHITECT IS NOT LIABLE FOR WATER PROOFING ISSUES. BY USING THESE PLANS THE CONTRACTOR TAKES ALL LIABILITY FOR DAMAGE CAUSED BY WATER PROOFING ISSUES.</p> <p>FRAMING/FINISH NOTES</p> <p>25- UNLESS NOTED OTHERWISE, ALL FRAMING LUMBER SHALL BE: FSC CERTIFIED DOUGLAS FIR STANDARD GRADE (MIN. FB=950 PSI)</p> <p>26- UNLESS NOTED OTHERWISE, ALL EXPOSED (UNPAINTED) FINISH LUMBER SHALL BE: DOUGLAS FIR SELECT OR BETTER GRADE S4S.</p> <p>27- USE 5/8" TYPE WR GYP. BD. ("GREEN BOARD") AT ALL WET LOCATIONS, EXCEPT BENT TILE IN SHOWERS. D. USE 5/8" TYPE X GYP. BD. AT ALL BLINDWALLS AND IN FIRE RATED ASSEMBLIES.</p> <p>28- ATTACH ALL GYP.BD. TO STUDS WITH A MIN. OF 1-3/4" LONG STEEL DRYWALL NAILS WITH 0.102" DIA. SHANK AND 0.29" DIA. HEAD, SPACED 7" O.C., U.N.O.</p> <p>29- ALL WOOD TO BE LEFT EXPOSED TO WEATHER SHALL BE NON ARSENIC CONTAINING COPPER AZOLE TREATED WOOD OR REDWOOD (DOES NOT INCLUDE SIDING MATERIAL). ALL CONNECTORS, HARDWARE, SCREWS AND NAILS FOR SAME SHALL BE HDG OR STAINLESS STEEL.</p> <p>30- WOOD IMBEDDED INTO THE GROUND IN DIRECT CONTACT WITH THE EARTH AND USED FOR SUPPORT OF THE STRUCTURE SHALL BE TREATED WOOD</p> <p>31- PROVIDE NON-COMBUSTIBLE MATERIAL WITHIN 18" AT ALL SURFACES OF HEAT PRODUCING EQUIPMENT AS PER CODE REQUIREMENTS.</p> <p>32- PROVIDE FIRE BLOCKING AND DRAFT STOPS IN CONCEALED CAVITIES IN ACCORDANCE WITH CRC SECTION 708.</p> <p>33- PROVIDE SOLID BLOCKING & BACKING AT ALL RAILS, CABINETS, AND MOUNTING OF EQUIPMENT AND ACCESSORIES (EG TOWEL BARS, SHELVES, ETC.).</p> <p>ADDITIONS:</p> <p>34- GROUND MUST BE GRADED TO SLOPE 6 INCHES WITHIN THE FIRST 10 FEET (5%) FROM ANY STRUCTURE FOUNDATION. CRC R401.3</p> <p>35- ALL NEW/REPLACEMENT EXTERIOR EGRESS DOORWAYS SHALL BE PROVIDED WITH LEVEL LANDINGS ON BOTH SIDES OF EACH DOORWAY AND WITH THRESHOLDS WHICH DO NOT EXCEED 1 1/2" IN HEIGHT FOR OUT-SWINGING DOORS, 7/8" FOR IN-SWINGING DOORS. OTHER EXTERIOR DOORS MAY HAVE NO MORE THAN TWO STEPS UP TO AN IN-SWINGING DOOR WITH A MAXIMUM OF 7 3/4" HEIGHT IN VERTICAL RISE. OTHER OUT-SWINGING EXTERIOR DOORS MAY SWING OVER A LANDING WHICH IS A MAXIMUM OF 7 1/4" IN HEIGHT FROM THE TOP OF THE THRESHOLD TO THE TOP OF A LANDING. RESIDENTIAL LANDINGS MUST BE AT LEAST 36" X 36", OR THE WIDTH OF THE DOOR, WHICHEVER IS GREATER.</p> <p>36- PROVIDE AN ATTIC ACCESS PANEL LOCATED IN THE HALLWAY THAT IS AT LEAST 20" X 30" WITH 30" MINIMUM CLEARANCE OVERHEAD. IF ANY APPLIANCES (WATER HEATER OR FURNACE) ARE LOCATED IN THE ATTIC, THE OPENING MUST BE AT LEAST 22" X 30". (CBC 1209)(CPC 509.4)</p> <p>37- PROVIDE ATTIC VENTILATION AT A RATIO OF 1/150 OF THE SQ. FT. OF THE AREA SERVED OR 1/300 OF THE SQ. FT. OF THE AREA SERVED IF 50% OF THE VENTS ARE ABOVE THE EAVES AND ARE BALANCED AT THE EAVES.</p> <p>38- UNDER FLOOR VENTS MUST BE PROVIDED WITH AT LEAST 1 SQ. FT. OF VENTILATION FOR EVERY 150 SQ. FT. OF AREA PER CBC 2317.7. VENTS MUST BE COVERED WITH 1/4" WIRE MESH SCREENING.</p> <p>39- SHOW THE LOCATION OF AN 18" X 24" MINIMUM CRAWL SPACE ACCESS DOOR. PROVIDE ACCESS TO ALL UNDER-FLOOR AREAS.</p> <p>40- ALL ROOF COVERINGS MUST BE A CLASS A ASSEMBLY AND THE ROOF SHEATHING MUST HAVE A RADIANT BARRIER.</p>	<table border="1"> <tbody> <tr><td>ABV</td><td>ABOVE</td></tr> <tr><td>AFF</td><td>ABOVE FINISHED FLOOR</td></tr> <tr><td>ASC</td><td>ABOVE SUSPENDED CEILING</td></tr> <tr><td>AP</td><td>ACCESS PANEL</td></tr> <tr><td>ACT</td><td>ACOUSTIC CEILING TILE</td></tr> <tr><td>ACOUS</td><td>ACOUSTICAL</td></tr> <tr><td>ADT</td><td>ADHESIVE</td></tr> <tr><td>ADJ</td><td>ADJACENT, ADJUSTABLE</td></tr> <tr><td>AGGR</td><td>AGGREGATE</td></tr> <tr><td>AVC</td><td>AIR CONDITIONING</td></tr> <tr><td>ALT</td><td>ALTERNATE</td></tr> <tr><td>ALUM</td><td>ALUMINUM</td></tr> <tr><td>AB</td><td>ANCHOR BOLT</td></tr> <tr><td>ANOD</td><td>ANODIZED</td></tr> <tr><td>APPD</td><td>APPROVED</td></tr> <tr><td>APROX</td><td>APPROXIMATE</td></tr> <tr><td>ARCHT</td><td>ARCHITECT, ARCHITECTURAL</td></tr> <tr><td>AD</td><td>AREA DRAIN</td></tr> <tr><td>ASPH</td><td>ASPHALT</td></tr> <tr><td>BSMT</td><td>BASEMENT</td></tr> <tr><td>BM</td><td>BEAM</td></tr> <tr><td>BRG</td><td>BEARING</td></tr> <tr><td>BPL</td><td>BEARING PLATE</td></tr> <tr><td>BLW</td><td>BELCH</td></tr> <tr><td>BM</td><td>BENCH MARK</td></tr> <tr><td>BTWN</td><td>BETWEEN</td></tr> <tr><td>BVL</td><td>BEVEL (ED)</td></tr> <tr><td>BIT</td><td>BITUMINOUS</td></tr> <tr><td>BLK</td><td>BLOCK</td></tr> <tr><td>BLKG</td><td>BLOCKING</td></tr> <tr><td>BD</td><td>BOARD</td></tr> <tr><td>BOC</td><td>BOTTOM OF CURB</td></tr> <tr><td>BOT</td><td>BOTTOM</td></tr> <tr><td>BOS</td><td>BOTTOM OF STEEL</td></tr> <tr><td>BRDG</td><td>BRIDGING</td></tr> <tr><td>BTU</td><td>BRITISH THERMAL UNIT</td></tr> <tr><td>BRZ</td><td>BRONZE</td></tr> <tr><td>BLDG</td><td>BUILDING</td></tr> <tr><td>BUR</td><td>BUILT UP ROOFING</td></tr> <tr><td>CAB</td><td>CABINET</td></tr> <tr><td>CATV</td><td>CABLE TELEVISION</td></tr> <tr><td>CPT</td><td>CARPET</td></tr> <tr><td>CSMT</td><td>CASEMENT</td></tr> <tr><td>CI</td><td>CAST IRON</td></tr> <tr><td>CS</td><td>CAST STONE</td></tr> <tr><td>CIP</td><td>CAST-IN-PLACE</td></tr> <tr><td>CB</td><td>CATCH BASIN / CORNER BEAD</td></tr> <tr><td>CLG</td><td>CEILING</td></tr> <tr><td>CEM</td><td>CEMENT</td></tr> <tr><td>CTR</td><td>CENTER</td></tr> <tr><td>CIC</td><td>CENTER TO CENTER</td></tr> <tr><td>CER</td><td>CERAMIC</td></tr> <tr><td>CT</td><td>CERAMIC TILE</td></tr> <tr><td>CHFR</td><td>CHAMFER(ED)</td></tr> <tr><td>CIRC</td><td>CIRCULAR, CIRCUMFERENCE</td></tr> <tr><td>CO</td><td>CLEAN-OUT</td></tr> <tr><td>CLR</td><td>CLEAR</td></tr> <tr><td>CCTV</td><td>CLOSED-CIRCUIT TELEVISION</td></tr> <tr><td>CLO</td><td>CLOSET</td></tr> <tr><td>CW</td><td>COLD WATER</td></tr> <tr><td>COL</td><td>COLUMN</td></tr> <tr><td>COMB</td><td>COMBINATION OR COMBINE</td></tr> <tr><td>COMP</td><td>COMPOSITE</td></tr> <tr><td>CONC</td><td>CONCRETE</td></tr> <tr><td>CMU</td><td>CONCRETE MASONRY UNITS</td></tr> <tr><td>CONN</td><td>CONNECTION</td></tr> <tr><td>CONST</td><td>CONSTRUCTION</td></tr> <tr><td>CJ</td><td>CONTROL JOINT</td></tr> <tr><td>CONT</td><td>CONTINUOUS</td></tr> <tr><td>CONV</td><td>CONVECTION</td></tr> <tr><td>COORD</td><td>COORDINATE</td></tr> <tr><td>CORR</td><td>CORRUGATED</td></tr> <tr><td>CNTR</td><td>COUNTER</td></tr> <tr><td>CTSK</td><td>COUNTERSINK</td></tr> <tr><td>CS</td><td>COURSES</td></tr> <tr><td>CPL</td><td>COVER PLATE</td></tr> <tr><td>CU</td><td>CUBIC</td></tr> <tr><td>CULV</td><td>CULVERT</td></tr> <tr><td>DPR</td><td>DAMPER</td></tr> <tr><td>DP</td><td>DAMP PROOFING</td></tr> <tr><td>DL</td><td>DEAD LOAD</td></tr> <tr><td>Db</td><td>DECIBEL</td></tr> <tr><td>DKG</td><td>DECKING</td></tr> <tr><td>DEMO</td><td>DEMOLISH, DEMOLITION</td></tr> <tr><td>DMT</td><td>DEMOUNTABLE</td></tr> <tr><td>D</td><td>DEPTH, DRYER</td></tr> <tr><td>DET</td><td>DETAIL</td></tr> <tr><td>DIAG</td><td>DIAGONAL</td></tr> <tr><td>DIA</td><td>DIAMETER</td></tr> <tr><td>DIFF</td><td>DIFFUSERS</td></tr> <tr><td>DIM</td><td>DIMENSION</td></tr> <tr><td>RD</td><td>RADIATOR</td></tr> <tr><td>DW</td><td>DISHWASHER</td></tr> <tr><td>DISP</td><td>DISPOSAL</td></tr> <tr><td>DIST</td><td>DISTANCE</td></tr> <tr><td>DO</td><td>DITTO</td></tr> <tr><td>DIV</td><td>DIVISION</td></tr> <tr><td>DR</td><td>DOOR</td></tr> <tr><td>DBL</td><td>DOUBLE</td></tr> <tr><td>DN</td><td>DOWN</td></tr> <tr><td>DWR</td><td>DRAWER</td></tr> <tr><td>DWG</td><td>DRAWING</td></tr> <tr><td>DSP</td><td>DRY STAND PIPE</td></tr> <tr><td>DF</td><td>DRINKING FOUNTAIN</td></tr> <tr><td>EA</td><td>EACH</td></tr> <tr><td>EF</td><td>EACH FACE</td></tr> <tr><td>E</td><td>EAST</td></tr> <tr><td>EB</td><td>EDGE BAND</td></tr> <tr><td>EWC</td><td>ELECTRIC WATER COOLER</td></tr> <tr><td>EWH</td><td>ELECTRIC WATER HEATER</td></tr> <tr><td>ELEC</td><td>ELECTRIC, ELECTRICAL</td></tr> <tr><td>EP</td><td>ELECTRICAL PANEL</td></tr> <tr><td>EL</td><td>ELEVATION (SURVEY)</td></tr> <tr><td>ELEV</td><td>ELEVATOR</td></tr> <tr><td>EMER</td><td>EMERGENCY</td></tr> <tr><td>ENCL</td><td>ENCLOSE</td></tr> <tr><td>ENGR</td><td>ENGINEER</td></tr> <tr><td>EQ</td><td>EQUAL</td></tr> <tr><td>EST</td><td>ESTIMATE</td></tr> <tr><td>EXC</td><td>EXCAVATE</td></tr> <tr><td>EXEC</td><td>EXECUTIVE</td></tr> <tr><td>EXH</td><td>EXHAUST</td></tr> <tr><td>EX</td><td>EXHAUST FAN</td></tr> <tr><td>EXIST</td><td>EXISTING</td></tr> <tr><td>EJ</td><td>EXPANSION JOINT</td></tr> <tr><td>EXP</td><td>EXPANSION, EXPOSED</td></tr> <tr><td>EXT</td><td>EXTERIOR</td></tr> <tr><td>EXTR</td><td>EXTRUDED</td></tr> <tr><td>MACH</td><td>MACHINE</td></tr> <tr><td>MH</td><td>MANHOLE</td></tr> <tr><td>MFR</td><td>MANUFACTURER</td></tr> <tr><td>MB</td><td>MARKER BOARD</td></tr> <tr><td>MSRY</td><td>MASONRY</td></tr> <tr><td>MO</td><td>MASONRY OPENING</td></tr> <tr><td>ML</td><td>MATCHLINE</td></tr> <tr><td>MATL</td><td>MATERIAL</td></tr> <tr><td>MAX</td><td>MAXIMUM</td></tr> <tr><td>MECH</td><td>MECHANICAL</td></tr> <tr><td>MED</td><td>MEDIUM</td></tr> <tr><td>MEMB</td><td>MEMBRANE</td></tr> <tr><td>MTL</td><td>METAL</td></tr> <tr><td>MEZZ</td><td>MEZZANINE</td></tr> <tr><td>MLWK</td><td>MILLWORK</td></tr> <tr><td>MIN</td><td>MINIMUM</td></tr> <tr><td>MIR</td><td>MIRROR</td></tr> <tr><td>MISC</td><td>MISCELLANEOUS</td></tr> <tr><td>MOD</td><td>MODULAR</td></tr> <tr><td>MON</td><td>MONUMENT</td></tr> <tr><td>MLD</td><td>MOULDING</td></tr> <tr><td>MTD</td><td>MOUNTED</td></tr> <tr><td>MOV</td><td>MOVABLE</td></tr> <tr><td>MUL</td><td>MULLION</td></tr> <tr><td>NLR</td><td>NAILER</td></tr> <tr><td>NAT</td><td>NATURAL</td></tr> <tr><td>NRC</td><td>NOISE REDUCTION COEFFICIENT</td></tr> <tr><td>NOM</td><td>NOMINAL</td></tr> <tr><td>NPS</td><td>NOMINAL PIPE SIZE</td></tr> <tr><td>NS</td><td>NON-SLIP</td></tr> <tr><td>N</td><td>NORTH</td></tr> <tr><td>N/A</td><td>NOT APPLICABLE</td></tr> <tr><td>NIC</td><td>NOT IN CONTRACT</td></tr> <tr><td>NTS</td><td>NOT TO SCALE</td></tr> <tr><td>NO.</td><td>NUMBER</td></tr> <tr><td>OC</td><td>ON CENTER</td></tr> <tr><td>OPNG</td><td>OPENING</td></tr> <tr><td>OPP</td><td>OPPOSITE</td></tr> <tr><td>OH</td><td>OPPOSITE HAND</td></tr> <tr><td>ORN</td><td>ORNAMENTAL</td></tr> <tr><td>OZ</td><td>OUNCE</td></tr> <tr><td>OD</td><td>OUTSIDE DIAMETER (DIMENSION)</td></tr> <tr><td>OA</td><td>OVERALL</td></tr> <tr><td>OH</td><td>OVERHEAD</td></tr> <tr><td>PNT</td><td>PAINT</td></tr> <tr><td>PTD</td><td>PAINTED</td></tr> <tr><td>PR</td><td>PAIR</td></tr> <tr><td>PNL</td><td>PANEL</td></tr> <tr><td>PAR</td><td>PARALLEL</td></tr> <tr><td>PRKG</td><td>PARKING</td></tr> <tr><td>PBD</td><td>PARTICLE BOARD</td></tr> <tr><td>PART</td><td>PARTITION</td></tr> <tr><td>PSGR</td><td>PASSENGER</td></tr> <tr><td>PVMT</td><td>PAVEMENT</td></tr> <tr><td>PED</td><td>PEDESTAL</td></tr> <tr><td>PERF</td><td>PERFORATE</td></tr> <tr><td>PERI</td><td>PERIMETER</td></tr> <tr><td>PERP</td><td>PERPENDICULAR</td></tr> <tr><td>PH</td><td>PHASE</td></tr> <tr><td>PLAM</td><td>PLASTIC LAMINATE</td></tr> <tr><td>PL</td><td>PLATE</td></tr> <tr><td>PLBG</td><td>PLUMBING</td></tr> <tr><td>PLYWD</td><td>PLYWOOD</td></tr> <tr><td>PEN</td><td>PLYWOOD END NAIL</td></tr> <tr><td>PLUM</td><td>PLUMBING</td></tr> <tr><td>PNEU</td><td>PNEUMATIC</td></tr> <tr><td>PT</td><td>POINT</td></tr> <tr><td>PVC</td><td>POLY VINYL CHLORIDE</td></tr> <tr><td>LB</td><td>POUND</td></tr> <tr><td>PSF</td><td>POUNDS PER SQUARE FOOT</td></tr> <tr><td>PSI</td><td>POUNDS PER SQUARE INCH</td></tr> <tr><td>PC</td><td>PRECAST</td></tr> <tr><td>PREFAB</td><td>PREFABRICATED</td></tr> <tr><td>PREP</td><td>PREPARE</td></tr> <tr><td>PT</td><td>PRESSURE TREATED</td></tr> <tr><td>PROJ</td><td>PROJECT/PROJECTED</td></tr> <tr><td>PR</td><td>PROPERTY</td></tr> <tr><td>OP</td><td>PROPOSED</td></tr> <tr><td>QTY</td><td>QUANTITY</td></tr> <tr><td>QT</td><td>QUARRY TILE</td></tr> <tr><td>QTR</td><td>QUARTER</td></tr> <tr><td>RAD</td><td>RADIATOR</td></tr> <tr><td>R</td><td>RADIUS</td></tr> <tr><td>RLG</td><td>RAILING</td></tr> <tr><td>RWL</td><td>RAIN WATER LEADER (DS)</td></tr> <tr><td>REC</td><td>RECESSED</td></tr> <tr><td>RDWD</td><td>REDWOOD</td></tr> <tr><td>REF</td><td>REFERENCE (ALSO SEE RE)</td></tr> <tr><td>RFL</td><td>REFLECTED</td></tr> <tr><td>RFRG</td><td>REFRIGERATOR</td></tr> <tr><td>RE</td><td>REGARDING, REFER TO</td></tr> <tr><td>REG</td><td>REGISTER</td></tr> <tr><td>REINF</td><td>REINFORCED, REINFORCING</td></tr> <tr><td>RELOC</td><td>RELOCATED</td></tr> <tr><td>REM</td><td>REMOVE(D)</td></tr> <tr><td>REQ'D</td><td>REQUIRED</td></tr> <tr><td>REQ</td><td>REQUIREMENTS</td></tr> <tr><td>RES</td><td>RESILIENT</td></tr> <tr><td>RET</td><td>RETURN, RETAINING</td></tr> <tr><td>RA</td><td>RETURN AIR</td></tr> <tr><td>RAG</td><td>RETURN AIR GRILLE</td></tr> <tr><td>REV</td><td>REVISION OR REVISION</td></tr> <tr><td>RH</td><td>RIGHT HAND</td></tr> <tr><td>R</td><td>RISER</td></tr> <tr><td>RF</td><td>ROOF</td></tr> <tr><td>RD</td><td>ROOF DRAIN</td></tr> <tr><td>RFG</td><td>ROOFING</td></tr> <tr><td>RM</td><td>ROOM</td></tr> <tr><td>RO</td><td>ROUGH OPENING</td></tr> <tr><td>LAN</td><td>LANTERN</td></tr> <tr><td>LOC</td><td>LOCATION</td></tr> <tr><td>LKR</td><td>LOCKER</td></tr> <tr><td>LLH</td><td>LONG LEG HORIZONTAL</td></tr> <tr><td>LLV</td><td>LONG LEG VERTICAL</td></tr> <tr><td>LVR</td><td>LOW VOLT</td></tr> <tr><td>LP</td><td>LOW POINT</td></tr> <tr><td>LB</td><td>POUND</td></tr> <tr><td>SAN</td><td>SANITARY</td></tr> <tr><td>SCHED</td><td>SCHEDULE</td></tr> <tr><td>SLNT</td><td>SEALANT</td></tr> <tr><td>SCL</td><td>SELF-CLOSING</td></tr> <tr><td>SSK</td><td>SERVICE SINK</td></tr> <tr><td>SHT</td><td>SHEET</td></tr> <tr><td>SHTG</td><td>SHEETING OR SHEATHING</td></tr> <tr><td>SH</td><td>SHELVING, SHELF</td></tr> <tr><td>SHWR</td><td>SHOWER</td></tr> <tr><td>SIM</td><td>SIMILAR</td></tr> <tr><td>SOG</td><td>SLAB ON GRADE</td></tr> <tr><td>SL</td><td>SLOPE</td></tr> <tr><td>SD</td><td>SMOKE DETECTOR</td></tr> <tr><td>SC</td><td>SOLID CORE</td></tr> <tr><td>SCWD</td><td>SOLID CORE WOOD DOOR</td></tr> <tr><td>STC</td><td>SOUND TRANSMISSION COEFFICIENT</td></tr> <tr><td>S</td><td>SOUTH</td></tr> <tr><td>SPKR</td><td>SPEAKER</td></tr> <tr><td>SPEC</td><td>SPECIFICATION</td></tr> <tr><td>SPR</td><td>SPRINKLER</td></tr> <tr><td>SO</td><td>SQUARE</td></tr> <tr><td>SF</td><td>SQUARE FOOT/FEET</td></tr> <tr><td>SI</td><td>SQUARE INCH/INCHES</td></tr> <tr><td>SY</td><td>SQUARE YARD</td></tr> <tr><td>SS</td><td>STAINLESS STEEL</td></tr> <tr><td>STD</td><td>STANDARD</td></tr> <tr><td>STA</td><td>STATION</td></tr> <tr><td>STL</td><td>STEEL</td></tr> <tr><td>STOR</td><td>STORAGE</td></tr> <tr><td>STR</td><td>STRINGER</td></tr> <tr><td>STRUC</td><td>STRUCTURE, STRUCTURAL</td></tr> <tr><td>SUB</td><td>SUBSTITUTE</td></tr> <tr><td>SA</td><td>SUPPLY AIR</td></tr> <tr><td>SUSP</td><td>SUSPENDED</td></tr> <tr><td>SYM</td><td>SYMMETRICAL</td></tr> <tr><td>SYN</td><td>SYNTHETIC</td></tr> <tr><td>SY</td><td>SYSTEM</td></tr> <tr><td>S</td><td>S</td></tr> <tr><td>TAP</td><td>TACKABLE ACOUSTICAL PANEL</td></tr> <tr><td>TECH</td><td>TECHNICAL</td></tr> <tr><td>TEL</td><td>TELEPHONE</td></tr> <tr><td>TEMP</td><td>TEMPERATURE/TEMPORARY</td></tr> <tr><td>TERM</td><td>TERMINATE</td></tr> <tr><td>TC</td><td>TERRA COTTA/TOP OR CURB</td></tr> <tr><td>TZ</td><td>TERRAZZO</td></tr> <tr><td>THK</td><td>THICK, THICKNESS</td></tr> <tr><td>THRES</td><td>THRESHOLD</td></tr> <tr><td>TPD</td><td>TOILET PAPER DISPENSER</td></tr> <tr><td>TOL</td><td>TOLERANCE</td></tr> <tr><td>T&G</td><td>TONGUE AND GROOVE</td></tr> <tr><td>TOC</td><td>TOP OF CONCRETE</td></tr> <tr><td>TOV</td><td>TOP OF EXT. MASONRY VENEER</td></tr> <tr><td>TOF</td><td>TOP OF FINISH</td></tr> <tr><td>TOM</td><td>TOP OF MASONRY</td></tr> <tr><td>TOS</td><td>TOP OF STEEL</td></tr> <tr><td>TOW</td><td>TOP OF WALL</td></tr> <tr><td>TB & S</td><td>TOP, BOTTOM AND SIDES</td></tr> <tr><td>T</td><td>TREAD</td></tr> <tr><td>TRTD</td><td>TREATED</td></tr> <tr><td>TWD</td><td>TREATED WOOD</td></tr> <tr><td>TYP</td><td>TYPICAL</td></tr> <tr><td>UC</td><td>UNDERCUT</td></tr> <tr><td>UNFIN</td><td>UNFINISHED</td></tr> <tr><td>UV</td><td>UNIT VENTILATOR</td></tr> <tr><td>UON, UNO</td><td>UNLESS OTHERWISE NOTED</td></tr> <tr><td>UR</td><td>URINAL</td></tr> <tr><td>VAC</td><td>VACUUM</td></tr> <tr><td>VA</td><td>VALVE</td></tr> <tr><td>VB</td><td>VAPOR BARRIER</td></tr> <tr><td>VAR</td><td>VARIABLE</td></tr> <tr><td>VENT</td><td>VENTILATION</td></tr> <tr><td>VIF</td><td>VERIFY IN FIELD</td></tr> <tr><td>VERM</td><td>VERMICULITE</td></tr> <tr><td>VERT</td><td>VERTICAL</td></tr> <tr><td>VG</td><td>VERTICAL GRAIN</td></tr> <tr><td>VEST</td><td>VESTIBULE</td></tr> <tr><td>VB</td><td>VINYL BASE</td></tr> <tr><td>VCT</td><td>VINYL COMPOSITION TILE</td></tr> <tr><td>VVC</td><td>VINYL WALL COVERING</td></tr> <tr><td>WH</td><td>WATER HEATER</td></tr> <tr><td>WSTO</td><td>WATER STOP (@ CONC JOINT)</td></tr> <tr><td>WP</td><td>WATERPROOF, WATERPROOFING</td></tr> <tr><td>WSTRP</td><td>WEATHERSTRIP</td></tr> <tr><td>WT</td><td>WEIGHT</td></tr> <tr><td>WWF</td><td>WELDED WIRE FABRIC OR MESH</td></tr> <tr><td>WO</td><td>WHERE OCCURS</td></tr> <tr><td>WF</td><td>WIDE FLANGE</td></tr> <tr><td>W</td><td>WASH, WASHER, WEST, WATER</td></tr> <tr><td>WDW</td><td>WINDOW</td></tr> <tr><td>WI</td><td>WITH</td></tr> <tr><td>WO</td><td>WITHOUT</td></tr> <tr><td>WD</td><td>WOOD</td></tr> <tr><td>WB</td><td>WOOD BASE</td></tr> <tr><td>WPT</td><td>WORKING POINT</td></tr> <tr><td>WI</td><td>WROUGHT IRON</td></tr> <tr><td>AND</td><td>AND</td></tr> <tr><td>&</td><td>AT</td></tr> <tr><td>@</td><td>ANGLE</td></tr> <tr><td><</td><td>BY</td></tr> <tr><td>X</td><td>CENTERLINE</td></tr> <tr><td>∩</td><td>EQUAL</td></tr> <tr><td>=</td><td>POUND</td></tr> <tr><td>#</td><td>PROPERTY LINE</td></tr> </tbody> </table>	ABV	ABOVE	AFF	ABOVE FINISHED FLOOR	ASC	ABOVE SUSPENDED CEILING	AP	ACCESS PANEL	ACT	ACOUSTIC CEILING TILE	ACOUS	ACOUSTICAL	ADT	ADHESIVE	ADJ	ADJACENT, ADJUSTABLE	AGGR	AGGREGATE	AVC	AIR CONDITIONING	ALT	ALTERNATE	ALUM	ALUMINUM	AB	ANCHOR BOLT	ANOD	ANODIZED	APPD	APPROVED	APROX	APPROXIMATE	ARCHT	ARCHITECT, ARCHITECTURAL	AD	AREA DRAIN	ASPH	ASPHALT	BSMT	BASEMENT	BM	BEAM	BRG	BEARING	BPL	BEARING PLATE	BLW	BELCH	BM	BENCH MARK	BTWN	BETWEEN	BVL	BEVEL (ED)	BIT	BITUMINOUS	BLK	BLOCK	BLKG	BLOCKING	BD	BOARD	BOC	BOTTOM OF CURB	BOT	BOTTOM	BOS	BOTTOM OF STEEL	BRDG	BRIDGING	BTU	BRITISH THERMAL UNIT	BRZ	BRONZE	BLDG	BUILDING	BUR	BUILT UP ROOFING	CAB	CABINET	CATV	CABLE TELEVISION	CPT	CARPET	CSMT	CASEMENT	CI	CAST IRON	CS	CAST STONE	CIP	CAST-IN-PLACE	CB	CATCH BASIN / CORNER BEAD	CLG	CEILING	CEM	CEMENT	CTR	CENTER	CIC	CENTER TO CENTER	CER	CERAMIC	CT	CERAMIC TILE	CHFR	CHAMFER(ED)	CIRC	CIRCULAR, CIRCUMFERENCE	CO	CLEAN-OUT	CLR	CLEAR	CCTV	CLOSED-CIRCUIT TELEVISION	CLO	CLOSET	CW	COLD WATER	COL	COLUMN	COMB	COMBINATION OR COMBINE	COMP	COMPOSITE	CONC	CONCRETE	CMU	CONCRETE MASONRY UNITS	CONN	CONNECTION	CONST	CONSTRUCTION	CJ	CONTROL JOINT	CONT	CONTINUOUS	CONV	CONVECTION	COORD	COORDINATE	CORR	CORRUGATED	CNTR	COUNTER	CTSK	COUNTERSINK	CS	COURSES	CPL	COVER PLATE	CU	CUBIC	CULV	CULVERT	DPR	DAMPER	DP	DAMP PROOFING	DL	DEAD LOAD	Db	DECIBEL	DKG	DECKING	DEMO	DEMOLISH, DEMOLITION	DMT	DEMOUNTABLE	D	DEPTH, DRYER	DET	DETAIL	DIAG	DIAGONAL	DIA	DIAMETER	DIFF	DIFFUSERS	DIM	DIMENSION	RD	RADIATOR	DW	DISHWASHER	DISP	DISPOSAL	DIST	DISTANCE	DO	DITTO	DIV	DIVISION	DR	DOOR	DBL	DOUBLE	DN	DOWN	DWR	DRAWER	DWG	DRAWING	DSP	DRY STAND PIPE	DF	DRINKING FOUNTAIN	EA	EACH	EF	EACH FACE	E	EAST	EB	EDGE BAND	EWC	ELECTRIC WATER COOLER	EWH	ELECTRIC WATER HEATER	ELEC	ELECTRIC, ELECTRICAL	EP	ELECTRICAL PANEL	EL	ELEVATION (SURVEY)	ELEV	ELEVATOR	EMER	EMERGENCY	ENCL	ENCLOSE	ENGR	ENGINEER	EQ	EQUAL	EST	ESTIMATE	EXC	EXCAVATE	EXEC	EXECUTIVE	EXH	EXHAUST	EX	EXHAUST FAN	EXIST	EXISTING	EJ	EXPANSION JOINT	EXP	EXPANSION, EXPOSED	EXT	EXTERIOR	EXTR	EXTRUDED	MACH	MACHINE	MH	MANHOLE	MFR	MANUFACTURER	MB	MARKER BOARD	MSRY	MASONRY	MO	MASONRY OPENING	ML	MATCHLINE	MATL	MATERIAL	MAX	MAXIMUM	MECH	MECHANICAL	MED	MEDIUM	MEMB	MEMBRANE	MTL	METAL	MEZZ	MEZZANINE	MLWK	MILLWORK	MIN	MINIMUM	MIR	MIRROR	MISC	MISCELLANEOUS	MOD	MODULAR	MON	MONUMENT	MLD	MOULDING	MTD	MOUNTED	MOV	MOVABLE	MUL	MULLION	NLR	NAILER	NAT	NATURAL	NRC	NOISE REDUCTION COEFFICIENT	NOM	NOMINAL	NPS	NOMINAL PIPE SIZE	NS	NON-SLIP	N	NORTH	N/A	NOT APPLICABLE	NIC	NOT IN CONTRACT	NTS	NOT TO SCALE	NO.	NUMBER	OC	ON CENTER	OPNG	OPENING	OPP	OPPOSITE	OH	OPPOSITE HAND	ORN	ORNAMENTAL	OZ	OUNCE	OD	OUTSIDE DIAMETER (DIMENSION)	OA	OVERALL	OH	OVERHEAD	PNT	PAINT	PTD	PAINTED	PR	PAIR	PNL	PANEL	PAR	PARALLEL	PRKG	PARKING	PBD	PARTICLE BOARD	PART	PARTITION	PSGR	PASSENGER	PVMT	PAVEMENT	PED	PEDESTAL	PERF	PERFORATE	PERI	PERIMETER	PERP	PERPENDICULAR	PH	PHASE	PLAM	PLASTIC LAMINATE	PL	PLATE	PLBG	PLUMBING	PLYWD	PLYWOOD	PEN	PLYWOOD END NAIL	PLUM	PLUMBING	PNEU	PNEUMATIC	PT	POINT	PVC	POLY VINYL CHLORIDE	LB	POUND	PSF	POUNDS PER SQUARE FOOT	PSI	POUNDS PER SQUARE INCH	PC	PRECAST	PREFAB	PREFABRICATED	PREP	PREPARE	PT	PRESSURE TREATED	PROJ	PROJECT/PROJECTED	PR	PROPERTY	OP	PROPOSED	QTY	QUANTITY	QT	QUARRY TILE	QTR	QUARTER	RAD	RADIATOR	R	RADIUS	RLG	RAILING	RWL	RAIN WATER LEADER (DS)	REC	RECESSED	RDWD	REDWOOD	REF	REFERENCE (ALSO SEE RE)	RFL	REFLECTED	RFRG	REFRIGERATOR	RE	REGARDING, REFER TO	REG	REGISTER	REINF	REINFORCED, REINFORCING	RELOC	RELOCATED	REM	REMOVE(D)	REQ'D	REQUIRED	REQ	REQUIREMENTS	RES	RESILIENT	RET	RETURN, RETAINING	RA	RETURN AIR	RAG	RETURN AIR GRILLE	REV	REVISION OR REVISION	RH	RIGHT HAND	R	RISER	RF	ROOF	RD	ROOF DRAIN	RFG	ROOFING	RM	ROOM	RO	ROUGH OPENING	LAN	LANTERN	LOC	LOCATION	LKR	LOCKER	LLH	LONG LEG HORIZONTAL	LLV	LONG LEG VERTICAL	LVR	LOW VOLT	LP	LOW POINT	LB	POUND	SAN	SANITARY	SCHED	SCHEDULE	SLNT	SEALANT	SCL	SELF-CLOSING	SSK	SERVICE SINK	SHT	SHEET	SHTG	SHEETING OR SHEATHING	SH	SHELVING, SHELF	SHWR	SHOWER	SIM	SIMILAR	SOG	SLAB ON GRADE	SL	SLOPE	SD	SMOKE DETECTOR	SC	SOLID CORE	SCWD	SOLID CORE WOOD DOOR	STC	SOUND TRANSMISSION COEFFICIENT	S	SOUTH	SPKR	SPEAKER	SPEC	SPECIFICATION	SPR	SPRINKLER	SO	SQUARE	SF	SQUARE FOOT/FEET	SI	SQUARE INCH/INCHES	SY	SQUARE YARD	SS	STAINLESS STEEL	STD	STANDARD	STA	STATION	STL	STEEL	STOR	STORAGE	STR	STRINGER	STRUC	STRUCTURE, STRUCTURAL	SUB	SUBSTITUTE	SA	SUPPLY AIR	SUSP	SUSPENDED	SYM	SYMMETRICAL	SYN	SYNTHETIC	SY	SYSTEM	S	S	TAP	TACKABLE ACOUSTICAL PANEL	TECH	TECHNICAL	TEL	TELEPHONE	TEMP	TEMPERATURE/TEMPORARY	TERM	TERMINATE	TC	TERRA COTTA/TOP OR CURB	TZ	TERRAZZO	THK	THICK, THICKNESS	THRES	THRESHOLD	TPD	TOILET PAPER DISPENSER	TOL	TOLERANCE	T&G	TONGUE AND GROOVE	TOC	TOP OF CONCRETE	TOV	TOP OF EXT. MASONRY VENEER	TOF	TOP OF FINISH	TOM	TOP OF MASONRY	TOS	TOP OF STEEL	TOW	TOP OF WALL	TB & S	TOP, BOTTOM AND SIDES	T	TREAD	TRTD	TREATED	TWD	TREATED WOOD	TYP	TYPICAL	UC	UNDERCUT	UNFIN	UNFINISHED	UV	UNIT VENTILATOR	UON, UNO	UNLESS OTHERWISE NOTED	UR	URINAL	VAC	VACUUM	VA	VALVE	VB	VAPOR BARRIER	VAR	VARIABLE	VENT	VENTILATION	VIF	VERIFY IN FIELD	VERM	VERMICULITE	VERT	VERTICAL	VG	VERTICAL GRAIN	VEST	VESTIBULE	VB	VINYL BASE	VCT	VINYL COMPOSITION TILE	VVC	VINYL WALL COVERING	WH	WATER HEATER	WSTO	WATER STOP (@ CONC JOINT)	WP	WATERPROOF, WATERPROOFING	WSTRP	WEATHERSTRIP	WT	WEIGHT	WWF	WELDED WIRE FABRIC OR MESH	WO	WHERE OCCURS	WF	WIDE FLANGE	W	WASH, WASHER, WEST, WATER	WDW	WINDOW	WI	WITH	WO	WITHOUT	WD	WOOD	WB	WOOD BASE	WPT	WORKING POINT	WI	WROUGHT IRON	AND	AND	&	AT	@	ANGLE	<	BY	X	CENTERLINE	∩	EQUAL	=	POUND	#	PROPERTY LINE
ABV	ABOVE																																																																																																																																																																																																																																																																																																																																																																																																																																																																																																																																																																																																																																																																																																																								
AFF	ABOVE FINISHED FLOOR																																																																																																																																																																																																																																																																																																																																																																																																																																																																																																																																																																																																																																																																																																																								
ASC	ABOVE SUSPENDED CEILING																																																																																																																																																																																																																																																																																																																																																																																																																																																																																																																																																																																																																																																																																																																								
AP	ACCESS PANEL																																																																																																																																																																																																																																																																																																																																																																																																																																																																																																																																																																																																																																																																																																																								
ACT	ACOUSTIC CEILING TILE																																																																																																																																																																																																																																																																																																																																																																																																																																																																																																																																																																																																																																																																																																																								
ACOUS	ACOUSTICAL																																																																																																																																																																																																																																																																																																																																																																																																																																																																																																																																																																																																																																																																																																																								
ADT	ADHESIVE																																																																																																																																																																																																																																																																																																																																																																																																																																																																																																																																																																																																																																																																																																																								
ADJ	ADJACENT, ADJUSTABLE																																																																																																																																																																																																																																																																																																																																																																																																																																																																																																																																																																																																																																																																																																																								
AGGR	AGGREGATE																																																																																																																																																																																																																																																																																																																																																																																																																																																																																																																																																																																																																																																																																																																								
AVC	AIR CONDITIONING																																																																																																																																																																																																																																																																																																																																																																																																																																																																																																																																																																																																																																																																																																																								
ALT	ALTERNATE																																																																																																																																																																																																																																																																																																																																																																																																																																																																																																																																																																																																																																																																																																																								
ALUM	ALUMINUM																																																																																																																																																																																																																																																																																																																																																																																																																																																																																																																																																																																																																																																																																																																								
AB	ANCHOR BOLT																																																																																																																																																																																																																																																																																																																																																																																																																																																																																																																																																																																																																																																																																																																								
ANOD	ANODIZED																																																																																																																																																																																																																																																																																																																																																																																																																																																																																																																																																																																																																																																																																																																								
APPD	APPROVED																																																																																																																																																																																																																																																																																																																																																																																																																																																																																																																																																																																																																																																																																																																								
APROX	APPROXIMATE																																																																																																																																																																																																																																																																																																																																																																																																																																																																																																																																																																																																																																																																																																																								
ARCHT	ARCHITECT, ARCHITECTURAL																																																																																																																																																																																																																																																																																																																																																																																																																																																																																																																																																																																																																																																																																																																								
AD	AREA DRAIN																																																																																																																																																																																																																																																																																																																																																																																																																																																																																																																																																																																																																																																																																																																								
ASPH	ASPHALT																																																																																																																																																																																																																																																																																																																																																																																																																																																																																																																																																																																																																																																																																																																								
BSMT	BASEMENT																																																																																																																																																																																																																																																																																																																																																																																																																																																																																																																																																																																																																																																																																																																								
BM	BEAM																																																																																																																																																																																																																																																																																																																																																																																																																																																																																																																																																																																																																																																																																																																								
BRG	BEARING																																																																																																																																																																																																																																																																																																																																																																																																																																																																																																																																																																																																																																																																																																																								
BPL	BEARING PLATE																																																																																																																																																																																																																																																																																																																																																																																																																																																																																																																																																																																																																																																																																																																								
BLW	BELCH																																																																																																																																																																																																																																																																																																																																																																																																																																																																																																																																																																																																																																																																																																																								
BM	BENCH MARK																																																																																																																																																																																																																																																																																																																																																																																																																																																																																																																																																																																																																																																																																																																								
BTWN	BETWEEN																																																																																																																																																																																																																																																																																																																																																																																																																																																																																																																																																																																																																																																																																																																								
BVL	BEVEL (ED)																																																																																																																																																																																																																																																																																																																																																																																																																																																																																																																																																																																																																																																																																																																								
BIT	BITUMINOUS																																																																																																																																																																																																																																																																																																																																																																																																																																																																																																																																																																																																																																																																																																																								
BLK	BLOCK																																																																																																																																																																																																																																																																																																																																																																																																																																																																																																																																																																																																																																																																																																																								
BLKG	BLOCKING																																																																																																																																																																																																																																																																																																																																																																																																																																																																																																																																																																																																																																																																																																																								
BD	BOARD																																																																																																																																																																																																																																																																																																																																																																																																																																																																																																																																																																																																																																																																																																																								
BOC	BOTTOM OF CURB																																																																																																																																																																																																																																																																																																																																																																																																																																																																																																																																																																																																																																																																																																																								
BOT	BOTTOM																																																																																																																																																																																																																																																																																																																																																																																																																																																																																																																																																																																																																																																																																																																								
BOS	BOTTOM OF STEEL																																																																																																																																																																																																																																																																																																																																																																																																																																																																																																																																																																																																																																																																																																																								
BRDG	BRIDGING																																																																																																																																																																																																																																																																																																																																																																																																																																																																																																																																																																																																																																																																																																																								
BTU	BRITISH THERMAL UNIT																																																																																																																																																																																																																																																																																																																																																																																																																																																																																																																																																																																																																																																																																																																								
BRZ	BRONZE																																																																																																																																																																																																																																																																																																																																																																																																																																																																																																																																																																																																																																																																																																																								
BLDG	BUILDING																																																																																																																																																																																																																																																																																																																																																																																																																																																																																																																																																																																																																																																																																																																								
BUR	BUILT UP ROOFING																																																																																																																																																																																																																																																																																																																																																																																																																																																																																																																																																																																																																																																																																																																								
CAB	CABINET																																																																																																																																																																																																																																																																																																																																																																																																																																																																																																																																																																																																																																																																																																																								
CATV	CABLE TELEVISION																																																																																																																																																																																																																																																																																																																																																																																																																																																																																																																																																																																																																																																																																																																								
CPT	CARPET																																																																																																																																																																																																																																																																																																																																																																																																																																																																																																																																																																																																																																																																																																																								
CSMT	CASEMENT																																																																																																																																																																																																																																																																																																																																																																																																																																																																																																																																																																																																																																																																																																																								
CI	CAST IRON																																																																																																																																																																																																																																																																																																																																																																																																																																																																																																																																																																																																																																																																																																																								
CS	CAST STONE																																																																																																																																																																																																																																																																																																																																																																																																																																																																																																																																																																																																																																																																																																																								
CIP	CAST-IN-PLACE																																																																																																																																																																																																																																																																																																																																																																																																																																																																																																																																																																																																																																																																																																																								
CB	CATCH BASIN / CORNER BEAD																																																																																																																																																																																																																																																																																																																																																																																																																																																																																																																																																																																																																																																																																																																								
CLG	CEILING																																																																																																																																																																																																																																																																																																																																																																																																																																																																																																																																																																																																																																																																																																																								
CEM	CEMENT																																																																																																																																																																																																																																																																																																																																																																																																																																																																																																																																																																																																																																																																																																																								
CTR	CENTER																																																																																																																																																																																																																																																																																																																																																																																																																																																																																																																																																																																																																																																																																																																								
CIC	CENTER TO CENTER																																																																																																																																																																																																																																																																																																																																																																																																																																																																																																																																																																																																																																																																																																																								
CER	CERAMIC																																																																																																																																																																																																																																																																																																																																																																																																																																																																																																																																																																																																																																																																																																																								
CT	CERAMIC TILE																																																																																																																																																																																																																																																																																																																																																																																																																																																																																																																																																																																																																																																																																																																								
CHFR	CHAMFER(ED)																																																																																																																																																																																																																																																																																																																																																																																																																																																																																																																																																																																																																																																																																																																								
CIRC	CIRCULAR, CIRCUMFERENCE																																																																																																																																																																																																																																																																																																																																																																																																																																																																																																																																																																																																																																																																																																																								
CO	CLEAN-OUT																																																																																																																																																																																																																																																																																																																																																																																																																																																																																																																																																																																																																																																																																																																								
CLR	CLEAR																																																																																																																																																																																																																																																																																																																																																																																																																																																																																																																																																																																																																																																																																																																								
CCTV	CLOSED-CIRCUIT TELEVISION																																																																																																																																																																																																																																																																																																																																																																																																																																																																																																																																																																																																																																																																																																																								
CLO	CLOSET																																																																																																																																																																																																																																																																																																																																																																																																																																																																																																																																																																																																																																																																																																																								
CW	COLD WATER																																																																																																																																																																																																																																																																																																																																																																																																																																																																																																																																																																																																																																																																																																																								
COL	COLUMN																																																																																																																																																																																																																																																																																																																																																																																																																																																																																																																																																																																																																																																																																																																								
COMB	COMBINATION OR COMBINE																																																																																																																																																																																																																																																																																																																																																																																																																																																																																																																																																																																																																																																																																																																								
COMP	COMPOSITE																																																																																																																																																																																																																																																																																																																																																																																																																																																																																																																																																																																																																																																																																																																								
CONC	CONCRETE																																																																																																																																																																																																																																																																																																																																																																																																																																																																																																																																																																																																																																																																																																																								
CMU	CONCRETE MASONRY UNITS																																																																																																																																																																																																																																																																																																																																																																																																																																																																																																																																																																																																																																																																																																																								
CONN	CONNECTION																																																																																																																																																																																																																																																																																																																																																																																																																																																																																																																																																																																																																																																																																																																								
CONST	CONSTRUCTION																																																																																																																																																																																																																																																																																																																																																																																																																																																																																																																																																																																																																																																																																																																								
CJ	CONTROL JOINT																																																																																																																																																																																																																																																																																																																																																																																																																																																																																																																																																																																																																																																																																																																								
CONT	CONTINUOUS																																																																																																																																																																																																																																																																																																																																																																																																																																																																																																																																																																																																																																																																																																																								
CONV	CONVECTION																																																																																																																																																																																																																																																																																																																																																																																																																																																																																																																																																																																																																																																																																																																								
COORD	COORDINATE																																																																																																																																																																																																																																																																																																																																																																																																																																																																																																																																																																																																																																																																																																																								
CORR	CORRUGATED																																																																																																																																																																																																																																																																																																																																																																																																																																																																																																																																																																																																																																																																																																																								
CNTR	COUNTER																																																																																																																																																																																																																																																																																																																																																																																																																																																																																																																																																																																																																																																																																																																								
CTSK	COUNTERSINK																																																																																																																																																																																																																																																																																																																																																																																																																																																																																																																																																																																																																																																																																																																								
CS	COURSES																																																																																																																																																																																																																																																																																																																																																																																																																																																																																																																																																																																																																																																																																																																								
CPL	COVER PLATE																																																																																																																																																																																																																																																																																																																																																																																																																																																																																																																																																																																																																																																																																																																								
CU	CUBIC																																																																																																																																																																																																																																																																																																																																																																																																																																																																																																																																																																																																																																																																																																																								
CULV	CULVERT																																																																																																																																																																																																																																																																																																																																																																																																																																																																																																																																																																																																																																																																																																																								
DPR	DAMPER																																																																																																																																																																																																																																																																																																																																																																																																																																																																																																																																																																																																																																																																																																																								
DP	DAMP PROOFING																																																																																																																																																																																																																																																																																																																																																																																																																																																																																																																																																																																																																																																																																																																								
DL	DEAD LOAD																																																																																																																																																																																																																																																																																																																																																																																																																																																																																																																																																																																																																																																																																																																								
Db	DECIBEL																																																																																																																																																																																																																																																																																																																																																																																																																																																																																																																																																																																																																																																																																																																								
DKG	DECKING																																																																																																																																																																																																																																																																																																																																																																																																																																																																																																																																																																																																																																																																																																																								
DEMO	DEMOLISH, DEMOLITION																																																																																																																																																																																																																																																																																																																																																																																																																																																																																																																																																																																																																																																																																																																								
DMT	DEMOUNTABLE																																																																																																																																																																																																																																																																																																																																																																																																																																																																																																																																																																																																																																																																																																																								
D	DEPTH, DRYER																																																																																																																																																																																																																																																																																																																																																																																																																																																																																																																																																																																																																																																																																																																								
DET	DETAIL																																																																																																																																																																																																																																																																																																																																																																																																																																																																																																																																																																																																																																																																																																																								
DIAG	DIAGONAL																																																																																																																																																																																																																																																																																																																																																																																																																																																																																																																																																																																																																																																																																																																								
DIA	DIAMETER																																																																																																																																																																																																																																																																																																																																																																																																																																																																																																																																																																																																																																																																																																																								
DIFF	DIFFUSERS																																																																																																																																																																																																																																																																																																																																																																																																																																																																																																																																																																																																																																																																																																																								
DIM	DIMENSION																																																																																																																																																																																																																																																																																																																																																																																																																																																																																																																																																																																																																																																																																																																								
RD	RADIATOR																																																																																																																																																																																																																																																																																																																																																																																																																																																																																																																																																																																																																																																																																																																								
DW	DISHWASHER																																																																																																																																																																																																																																																																																																																																																																																																																																																																																																																																																																																																																																																																																																																								
DISP	DISPOSAL																																																																																																																																																																																																																																																																																																																																																																																																																																																																																																																																																																																																																																																																																																																								
DIST	DISTANCE																																																																																																																																																																																																																																																																																																																																																																																																																																																																																																																																																																																																																																																																																																																								
DO	DITTO																																																																																																																																																																																																																																																																																																																																																																																																																																																																																																																																																																																																																																																																																																																								
DIV	DIVISION																																																																																																																																																																																																																																																																																																																																																																																																																																																																																																																																																																																																																																																																																																																								
DR	DOOR																																																																																																																																																																																																																																																																																																																																																																																																																																																																																																																																																																																																																																																																																																																								
DBL	DOUBLE																																																																																																																																																																																																																																																																																																																																																																																																																																																																																																																																																																																																																																																																																																																								
DN	DOWN																																																																																																																																																																																																																																																																																																																																																																																																																																																																																																																																																																																																																																																																																																																								
DWR	DRAWER																																																																																																																																																																																																																																																																																																																																																																																																																																																																																																																																																																																																																																																																																																																								
DWG	DRAWING																																																																																																																																																																																																																																																																																																																																																																																																																																																																																																																																																																																																																																																																																																																								
DSP	DRY STAND PIPE																																																																																																																																																																																																																																																																																																																																																																																																																																																																																																																																																																																																																																																																																																																								
DF	DRINKING FOUNTAIN																																																																																																																																																																																																																																																																																																																																																																																																																																																																																																																																																																																																																																																																																																																								
EA	EACH																																																																																																																																																																																																																																																																																																																																																																																																																																																																																																																																																																																																																																																																																																																								
EF	EACH FACE																																																																																																																																																																																																																																																																																																																																																																																																																																																																																																																																																																																																																																																																																																																								
E	EAST																																																																																																																																																																																																																																																																																																																																																																																																																																																																																																																																																																																																																																																																																																																								
EB	EDGE BAND																																																																																																																																																																																																																																																																																																																																																																																																																																																																																																																																																																																																																																																																																																																								
EWC	ELECTRIC WATER COOLER																																																																																																																																																																																																																																																																																																																																																																																																																																																																																																																																																																																																																																																																																																																								
EWH	ELECTRIC WATER HEATER																																																																																																																																																																																																																																																																																																																																																																																																																																																																																																																																																																																																																																																																																																																								
ELEC	ELECTRIC, ELECTRICAL																																																																																																																																																																																																																																																																																																																																																																																																																																																																																																																																																																																																																																																																																																																								
EP	ELECTRICAL PANEL																																																																																																																																																																																																																																																																																																																																																																																																																																																																																																																																																																																																																																																																																																																								
EL	ELEVATION (SURVEY)																																																																																																																																																																																																																																																																																																																																																																																																																																																																																																																																																																																																																																																																																																																								
ELEV	ELEVATOR																																																																																																																																																																																																																																																																																																																																																																																																																																																																																																																																																																																																																																																																																																																								
EMER	EMERGENCY																																																																																																																																																																																																																																																																																																																																																																																																																																																																																																																																																																																																																																																																																																																								
ENCL	ENCLOSE																																																																																																																																																																																																																																																																																																																																																																																																																																																																																																																																																																																																																																																																																																																								
ENGR	ENGINEER																																																																																																																																																																																																																																																																																																																																																																																																																																																																																																																																																																																																																																																																																																																								
EQ	EQUAL																																																																																																																																																																																																																																																																																																																																																																																																																																																																																																																																																																																																																																																																																																																								
EST	ESTIMATE																																																																																																																																																																																																																																																																																																																																																																																																																																																																																																																																																																																																																																																																																																																								
EXC	EXCAVATE																																																																																																																																																																																																																																																																																																																																																																																																																																																																																																																																																																																																																																																																																																																								
EXEC	EXECUTIVE																																																																																																																																																																																																																																																																																																																																																																																																																																																																																																																																																																																																																																																																																																																								
EXH	EXHAUST																																																																																																																																																																																																																																																																																																																																																																																																																																																																																																																																																																																																																																																																																																																								
EX	EXHAUST FAN																																																																																																																																																																																																																																																																																																																																																																																																																																																																																																																																																																																																																																																																																																																								
EXIST	EXISTING																																																																																																																																																																																																																																																																																																																																																																																																																																																																																																																																																																																																																																																																																																																								
EJ	EXPANSION JOINT																																																																																																																																																																																																																																																																																																																																																																																																																																																																																																																																																																																																																																																																																																																								
EXP	EXPANSION, EXPOSED																																																																																																																																																																																																																																																																																																																																																																																																																																																																																																																																																																																																																																																																																																																								
EXT	EXTERIOR																																																																																																																																																																																																																																																																																																																																																																																																																																																																																																																																																																																																																																																																																																																								
EXTR	EXTRUDED																																																																																																																																																																																																																																																																																																																																																																																																																																																																																																																																																																																																																																																																																																																								
MACH	MACHINE																																																																																																																																																																																																																																																																																																																																																																																																																																																																																																																																																																																																																																																																																																																								
MH	MANHOLE																																																																																																																																																																																																																																																																																																																																																																																																																																																																																																																																																																																																																																																																																																																								
MFR	MANUFACTURER																																																																																																																																																																																																																																																																																																																																																																																																																																																																																																																																																																																																																																																																																																																								
MB	MARKER BOARD																																																																																																																																																																																																																																																																																																																																																																																																																																																																																																																																																																																																																																																																																																																								
MSRY	MASONRY																																																																																																																																																																																																																																																																																																																																																																																																																																																																																																																																																																																																																																																																																																																								
MO	MASONRY OPENING																																																																																																																																																																																																																																																																																																																																																																																																																																																																																																																																																																																																																																																																																																																								
ML	MATCHLINE																																																																																																																																																																																																																																																																																																																																																																																																																																																																																																																																																																																																																																																																																																																								
MATL	MATERIAL																																																																																																																																																																																																																																																																																																																																																																																																																																																																																																																																																																																																																																																																																																																								
MAX	MAXIMUM																																																																																																																																																																																																																																																																																																																																																																																																																																																																																																																																																																																																																																																																																																																								
MECH	MECHANICAL																																																																																																																																																																																																																																																																																																																																																																																																																																																																																																																																																																																																																																																																																																																								
MED	MEDIUM																																																																																																																																																																																																																																																																																																																																																																																																																																																																																																																																																																																																																																																																																																																								
MEMB	MEMBRANE																																																																																																																																																																																																																																																																																																																																																																																																																																																																																																																																																																																																																																																																																																																								
MTL	METAL																																																																																																																																																																																																																																																																																																																																																																																																																																																																																																																																																																																																																																																																																																																								
MEZZ	MEZZANINE																																																																																																																																																																																																																																																																																																																																																																																																																																																																																																																																																																																																																																																																																																																								
MLWK	MILLWORK																																																																																																																																																																																																																																																																																																																																																																																																																																																																																																																																																																																																																																																																																																																								
MIN	MINIMUM																																																																																																																																																																																																																																																																																																																																																																																																																																																																																																																																																																																																																																																																																																																								
MIR	MIRROR																																																																																																																																																																																																																																																																																																																																																																																																																																																																																																																																																																																																																																																																																																																								
MISC	MISCELLANEOUS																																																																																																																																																																																																																																																																																																																																																																																																																																																																																																																																																																																																																																																																																																																								
MOD	MODULAR																																																																																																																																																																																																																																																																																																																																																																																																																																																																																																																																																																																																																																																																																																																								
MON	MONUMENT																																																																																																																																																																																																																																																																																																																																																																																																																																																																																																																																																																																																																																																																																																																								
MLD	MOULDING																																																																																																																																																																																																																																																																																																																																																																																																																																																																																																																																																																																																																																																																																																																								
MTD	MOUNTED																																																																																																																																																																																																																																																																																																																																																																																																																																																																																																																																																																																																																																																																																																																								
MOV	MOVABLE																																																																																																																																																																																																																																																																																																																																																																																																																																																																																																																																																																																																																																																																																																																								
MUL	MULLION																																																																																																																																																																																																																																																																																																																																																																																																																																																																																																																																																																																																																																																																																																																								
NLR	NAILER																																																																																																																																																																																																																																																																																																																																																																																																																																																																																																																																																																																																																																																																																																																								
NAT	NATURAL																																																																																																																																																																																																																																																																																																																																																																																																																																																																																																																																																																																																																																																																																																																								
NRC	NOISE REDUCTION COEFFICIENT																																																																																																																																																																																																																																																																																																																																																																																																																																																																																																																																																																																																																																																																																																																								
NOM	NOMINAL																																																																																																																																																																																																																																																																																																																																																																																																																																																																																																																																																																																																																																																																																																																								
NPS	NOMINAL PIPE SIZE																																																																																																																																																																																																																																																																																																																																																																																																																																																																																																																																																																																																																																																																																																																								
NS	NON-SLIP																																																																																																																																																																																																																																																																																																																																																																																																																																																																																																																																																																																																																																																																																																																								
N	NORTH																																																																																																																																																																																																																																																																																																																																																																																																																																																																																																																																																																																																																																																																																																																								
N/A	NOT APPLICABLE																																																																																																																																																																																																																																																																																																																																																																																																																																																																																																																																																																																																																																																																																																																								
NIC	NOT IN CONTRACT																																																																																																																																																																																																																																																																																																																																																																																																																																																																																																																																																																																																																																																																																																																								
NTS	NOT TO SCALE																																																																																																																																																																																																																																																																																																																																																																																																																																																																																																																																																																																																																																																																																																																								
NO.	NUMBER																																																																																																																																																																																																																																																																																																																																																																																																																																																																																																																																																																																																																																																																																																																								
OC	ON CENTER																																																																																																																																																																																																																																																																																																																																																																																																																																																																																																																																																																																																																																																																																																																								
OPNG	OPENING																																																																																																																																																																																																																																																																																																																																																																																																																																																																																																																																																																																																																																																																																																																								
OPP	OPPOSITE																																																																																																																																																																																																																																																																																																																																																																																																																																																																																																																																																																																																																																																																																																																								
OH	OPPOSITE HAND																																																																																																																																																																																																																																																																																																																																																																																																																																																																																																																																																																																																																																																																																																																								
ORN	ORNAMENTAL																																																																																																																																																																																																																																																																																																																																																																																																																																																																																																																																																																																																																																																																																																																								
OZ	OUNCE																																																																																																																																																																																																																																																																																																																																																																																																																																																																																																																																																																																																																																																																																																																								
OD	OUTSIDE DIAMETER (DIMENSION)																																																																																																																																																																																																																																																																																																																																																																																																																																																																																																																																																																																																																																																																																																																								
OA	OVERALL																																																																																																																																																																																																																																																																																																																																																																																																																																																																																																																																																																																																																																																																																																																								
OH	OVERHEAD																																																																																																																																																																																																																																																																																																																																																																																																																																																																																																																																																																																																																																																																																																																								
PNT	PAINT																																																																																																																																																																																																																																																																																																																																																																																																																																																																																																																																																																																																																																																																																																																								
PTD	PAINTED																																																																																																																																																																																																																																																																																																																																																																																																																																																																																																																																																																																																																																																																																																																								
PR	PAIR																																																																																																																																																																																																																																																																																																																																																																																																																																																																																																																																																																																																																																																																																																																								
PNL	PANEL																																																																																																																																																																																																																																																																																																																																																																																																																																																																																																																																																																																																																																																																																																																								
PAR	PARALLEL																																																																																																																																																																																																																																																																																																																																																																																																																																																																																																																																																																																																																																																																																																																								
PRKG	PARKING																																																																																																																																																																																																																																																																																																																																																																																																																																																																																																																																																																																																																																																																																																																								
PBD	PARTICLE BOARD																																																																																																																																																																																																																																																																																																																																																																																																																																																																																																																																																																																																																																																																																																																								
PART	PARTITION																																																																																																																																																																																																																																																																																																																																																																																																																																																																																																																																																																																																																																																																																																																								
PSGR	PASSENGER																																																																																																																																																																																																																																																																																																																																																																																																																																																																																																																																																																																																																																																																																																																								
PVMT	PAVEMENT																																																																																																																																																																																																																																																																																																																																																																																																																																																																																																																																																																																																																																																																																																																								
PED	PEDESTAL																																																																																																																																																																																																																																																																																																																																																																																																																																																																																																																																																																																																																																																																																																																								
PERF	PERFORATE																																																																																																																																																																																																																																																																																																																																																																																																																																																																																																																																																																																																																																																																																																																								
PERI	PERIMETER																																																																																																																																																																																																																																																																																																																																																																																																																																																																																																																																																																																																																																																																																																																								
PERP	PERPENDICULAR																																																																																																																																																																																																																																																																																																																																																																																																																																																																																																																																																																																																																																																																																																																								
PH	PHASE																																																																																																																																																																																																																																																																																																																																																																																																																																																																																																																																																																																																																																																																																																																								
PLAM	PLASTIC LAMINATE																																																																																																																																																																																																																																																																																																																																																																																																																																																																																																																																																																																																																																																																																																																								
PL	PLATE																																																																																																																																																																																																																																																																																																																																																																																																																																																																																																																																																																																																																																																																																																																								
PLBG	PLUMBING																																																																																																																																																																																																																																																																																																																																																																																																																																																																																																																																																																																																																																																																																																																								
PLYWD	PLYWOOD																																																																																																																																																																																																																																																																																																																																																																																																																																																																																																																																																																																																																																																																																																																								
PEN	PLYWOOD END NAIL																																																																																																																																																																																																																																																																																																																																																																																																																																																																																																																																																																																																																																																																																																																								
PLUM	PLUMBING																																																																																																																																																																																																																																																																																																																																																																																																																																																																																																																																																																																																																																																																																																																								
PNEU	PNEUMATIC																																																																																																																																																																																																																																																																																																																																																																																																																																																																																																																																																																																																																																																																																																																								
PT	POINT																																																																																																																																																																																																																																																																																																																																																																																																																																																																																																																																																																																																																																																																																																																								
PVC	POLY VINYL CHLORIDE																																																																																																																																																																																																																																																																																																																																																																																																																																																																																																																																																																																																																																																																																																																								
LB	POUND																																																																																																																																																																																																																																																																																																																																																																																																																																																																																																																																																																																																																																																																																																																								
PSF	POUNDS PER SQUARE FOOT																																																																																																																																																																																																																																																																																																																																																																																																																																																																																																																																																																																																																																																																																																																								
PSI	POUNDS PER SQUARE INCH																																																																																																																																																																																																																																																																																																																																																																																																																																																																																																																																																																																																																																																																																																																								
PC	PRECAST																																																																																																																																																																																																																																																																																																																																																																																																																																																																																																																																																																																																																																																																																																																								
PREFAB	PREFABRICATED																																																																																																																																																																																																																																																																																																																																																																																																																																																																																																																																																																																																																																																																																																																								
PREP	PREPARE																																																																																																																																																																																																																																																																																																																																																																																																																																																																																																																																																																																																																																																																																																																								
PT	PRESSURE TREATED																																																																																																																																																																																																																																																																																																																																																																																																																																																																																																																																																																																																																																																																																																																								
PROJ	PROJECT/PROJECTED																																																																																																																																																																																																																																																																																																																																																																																																																																																																																																																																																																																																																																																																																																																								
PR	PROPERTY																																																																																																																																																																																																																																																																																																																																																																																																																																																																																																																																																																																																																																																																																																																								
OP	PROPOSED																																																																																																																																																																																																																																																																																																																																																																																																																																																																																																																																																																																																																																																																																																																								
QTY	QUANTITY																																																																																																																																																																																																																																																																																																																																																																																																																																																																																																																																																																																																																																																																																																																								
QT	QUARRY TILE																																																																																																																																																																																																																																																																																																																																																																																																																																																																																																																																																																																																																																																																																																																								
QTR	QUARTER																																																																																																																																																																																																																																																																																																																																																																																																																																																																																																																																																																																																																																																																																																																								
RAD	RADIATOR																																																																																																																																																																																																																																																																																																																																																																																																																																																																																																																																																																																																																																																																																																																								
R	RADIUS																																																																																																																																																																																																																																																																																																																																																																																																																																																																																																																																																																																																																																																																																																																								
RLG	RAILING																																																																																																																																																																																																																																																																																																																																																																																																																																																																																																																																																																																																																																																																																																																								
RWL	RAIN WATER LEADER (DS)																																																																																																																																																																																																																																																																																																																																																																																																																																																																																																																																																																																																																																																																																																																								
REC	RECESSED																																																																																																																																																																																																																																																																																																																																																																																																																																																																																																																																																																																																																																																																																																																								
RDWD	REDWOOD																																																																																																																																																																																																																																																																																																																																																																																																																																																																																																																																																																																																																																																																																																																								
REF	REFERENCE (ALSO SEE RE)																																																																																																																																																																																																																																																																																																																																																																																																																																																																																																																																																																																																																																																																																																																								
RFL	REFLECTED																																																																																																																																																																																																																																																																																																																																																																																																																																																																																																																																																																																																																																																																																																																								
RFRG	REFRIGERATOR																																																																																																																																																																																																																																																																																																																																																																																																																																																																																																																																																																																																																																																																																																																								
RE	REGARDING, REFER TO																																																																																																																																																																																																																																																																																																																																																																																																																																																																																																																																																																																																																																																																																																																								
REG	REGISTER																																																																																																																																																																																																																																																																																																																																																																																																																																																																																																																																																																																																																																																																																																																								
REINF	REINFORCED, REINFORCING																																																																																																																																																																																																																																																																																																																																																																																																																																																																																																																																																																																																																																																																																																																								
RELOC	RELOCATED																																																																																																																																																																																																																																																																																																																																																																																																																																																																																																																																																																																																																																																																																																																								
REM	REMOVE(D)																																																																																																																																																																																																																																																																																																																																																																																																																																																																																																																																																																																																																																																																																																																								
REQ'D	REQUIRED																																																																																																																																																																																																																																																																																																																																																																																																																																																																																																																																																																																																																																																																																																																								
REQ	REQUIREMENTS																																																																																																																																																																																																																																																																																																																																																																																																																																																																																																																																																																																																																																																																																																																								
RES	RESILIENT																																																																																																																																																																																																																																																																																																																																																																																																																																																																																																																																																																																																																																																																																																																								
RET	RETURN, RETAINING																																																																																																																																																																																																																																																																																																																																																																																																																																																																																																																																																																																																																																																																																																																								
RA	RETURN AIR																																																																																																																																																																																																																																																																																																																																																																																																																																																																																																																																																																																																																																																																																																																								
RAG	RETURN AIR GRILLE																																																																																																																																																																																																																																																																																																																																																																																																																																																																																																																																																																																																																																																																																																																								
REV	REVISION OR REVISION																																																																																																																																																																																																																																																																																																																																																																																																																																																																																																																																																																																																																																																																																																																								
RH	RIGHT HAND																																																																																																																																																																																																																																																																																																																																																																																																																																																																																																																																																																																																																																																																																																																								
R	RISER																																																																																																																																																																																																																																																																																																																																																																																																																																																																																																																																																																																																																																																																																																																								
RF	ROOF																																																																																																																																																																																																																																																																																																																																																																																																																																																																																																																																																																																																																																																																																																																								
RD	ROOF DRAIN																																																																																																																																																																																																																																																																																																																																																																																																																																																																																																																																																																																																																																																																																																																								
RFG	ROOFING																																																																																																																																																																																																																																																																																																																																																																																																																																																																																																																																																																																																																																																																																																																								
RM	ROOM																																																																																																																																																																																																																																																																																																																																																																																																																																																																																																																																																																																																																																																																																																																								
RO	ROUGH OPENING																																																																																																																																																																																																																																																																																																																																																																																																																																																																																																																																																																																																																																																																																																																								
LAN	LANTERN																																																																																																																																																																																																																																																																																																																																																																																																																																																																																																																																																																																																																																																																																																																								
LOC	LOCATION																																																																																																																																																																																																																																																																																																																																																																																																																																																																																																																																																																																																																																																																																																																								
LKR	LOCKER																																																																																																																																																																																																																																																																																																																																																																																																																																																																																																																																																																																																																																																																																																																								
LLH	LONG LEG HORIZONTAL																																																																																																																																																																																																																																																																																																																																																																																																																																																																																																																																																																																																																																																																																																																								
LLV	LONG LEG VERTICAL																																																																																																																																																																																																																																																																																																																																																																																																																																																																																																																																																																																																																																																																																																																								
LVR	LOW VOLT																																																																																																																																																																																																																																																																																																																																																																																																																																																																																																																																																																																																																																																																																																																								
LP	LOW POINT																																																																																																																																																																																																																																																																																																																																																																																																																																																																																																																																																																																																																																																																																																																								
LB	POUND																																																																																																																																																																																																																																																																																																																																																																																																																																																																																																																																																																																																																																																																																																																								
SAN	SANITARY																																																																																																																																																																																																																																																																																																																																																																																																																																																																																																																																																																																																																																																																																																																								
SCHED	SCHEDULE																																																																																																																																																																																																																																																																																																																																																																																																																																																																																																																																																																																																																																																																																																																								
SLNT	SEALANT																																																																																																																																																																																																																																																																																																																																																																																																																																																																																																																																																																																																																																																																																																																								
SCL	SELF-CLOSING																																																																																																																																																																																																																																																																																																																																																																																																																																																																																																																																																																																																																																																																																																																								
SSK	SERVICE SINK																																																																																																																																																																																																																																																																																																																																																																																																																																																																																																																																																																																																																																																																																																																								
SHT	SHEET																																																																																																																																																																																																																																																																																																																																																																																																																																																																																																																																																																																																																																																																																																																								
SHTG	SHEETING OR SHEATHING																																																																																																																																																																																																																																																																																																																																																																																																																																																																																																																																																																																																																																																																																																																								
SH	SHELVING, SHELF																																																																																																																																																																																																																																																																																																																																																																																																																																																																																																																																																																																																																																																																																																																								
SHWR	SHOWER																																																																																																																																																																																																																																																																																																																																																																																																																																																																																																																																																																																																																																																																																																																								
SIM	SIMILAR																																																																																																																																																																																																																																																																																																																																																																																																																																																																																																																																																																																																																																																																																																																								
SOG	SLAB ON GRADE																																																																																																																																																																																																																																																																																																																																																																																																																																																																																																																																																																																																																																																																																																																								
SL	SLOPE																																																																																																																																																																																																																																																																																																																																																																																																																																																																																																																																																																																																																																																																																																																								
SD	SMOKE DETECTOR																																																																																																																																																																																																																																																																																																																																																																																																																																																																																																																																																																																																																																																																																																																								
SC	SOLID CORE																																																																																																																																																																																																																																																																																																																																																																																																																																																																																																																																																																																																																																																																																																																								
SCWD	SOLID CORE WOOD DOOR																																																																																																																																																																																																																																																																																																																																																																																																																																																																																																																																																																																																																																																																																																																								
STC	SOUND TRANSMISSION COEFFICIENT																																																																																																																																																																																																																																																																																																																																																																																																																																																																																																																																																																																																																																																																																																																								
S	SOUTH																																																																																																																																																																																																																																																																																																																																																																																																																																																																																																																																																																																																																																																																																																																								
SPKR	SPEAKER																																																																																																																																																																																																																																																																																																																																																																																																																																																																																																																																																																																																																																																																																																																								
SPEC	SPECIFICATION																																																																																																																																																																																																																																																																																																																																																																																																																																																																																																																																																																																																																																																																																																																								
SPR	SPRINKLER																																																																																																																																																																																																																																																																																																																																																																																																																																																																																																																																																																																																																																																																																																																								
SO	SQUARE																																																																																																																																																																																																																																																																																																																																																																																																																																																																																																																																																																																																																																																																																																																								
SF	SQUARE FOOT/FEET																																																																																																																																																																																																																																																																																																																																																																																																																																																																																																																																																																																																																																																																																																																								
SI	SQUARE INCH/INCHES																																																																																																																																																																																																																																																																																																																																																																																																																																																																																																																																																																																																																																																																																																																								
SY	SQUARE YARD																																																																																																																																																																																																																																																																																																																																																																																																																																																																																																																																																																																																																																																																																																																								
SS	STAINLESS STEEL																																																																																																																																																																																																																																																																																																																																																																																																																																																																																																																																																																																																																																																																																																																								
STD	STANDARD																																																																																																																																																																																																																																																																																																																																																																																																																																																																																																																																																																																																																																																																																																																								
STA	STATION																																																																																																																																																																																																																																																																																																																																																																																																																																																																																																																																																																																																																																																																																																																								
STL	STEEL																																																																																																																																																																																																																																																																																																																																																																																																																																																																																																																																																																																																																																																																																																																								
STOR	STORAGE																																																																																																																																																																																																																																																																																																																																																																																																																																																																																																																																																																																																																																																																																																																								
STR	STRINGER																																																																																																																																																																																																																																																																																																																																																																																																																																																																																																																																																																																																																																																																																																																								
STRUC	STRUCTURE, STRUCTURAL																																																																																																																																																																																																																																																																																																																																																																																																																																																																																																																																																																																																																																																																																																																								
SUB	SUBSTITUTE																																																																																																																																																																																																																																																																																																																																																																																																																																																																																																																																																																																																																																																																																																																								
SA	SUPPLY AIR																																																																																																																																																																																																																																																																																																																																																																																																																																																																																																																																																																																																																																																																																																																								
SUSP	SUSPENDED																																																																																																																																																																																																																																																																																																																																																																																																																																																																																																																																																																																																																																																																																																																								
SYM	SYMMETRICAL																																																																																																																																																																																																																																																																																																																																																																																																																																																																																																																																																																																																																																																																																																																								
SYN	SYNTHETIC																																																																																																																																																																																																																																																																																																																																																																																																																																																																																																																																																																																																																																																																																																																								
SY	SYSTEM																																																																																																																																																																																																																																																																																																																																																																																																																																																																																																																																																																																																																																																																																																																								
S	S																																																																																																																																																																																																																																																																																																																																																																																																																																																																																																																																																																																																																																																																																																																								
TAP	TACKABLE ACOUSTICAL PANEL																																																																																																																																																																																																																																																																																																																																																																																																																																																																																																																																																																																																																																																																																																																								
TECH	TECHNICAL																																																																																																																																																																																																																																																																																																																																																																																																																																																																																																																																																																																																																																																																																																																								
TEL	TELEPHONE																																																																																																																																																																																																																																																																																																																																																																																																																																																																																																																																																																																																																																																																																																																								
TEMP	TEMPERATURE/TEMPORARY																																																																																																																																																																																																																																																																																																																																																																																																																																																																																																																																																																																																																																																																																																																								
TERM	TERMINATE																																																																																																																																																																																																																																																																																																																																																																																																																																																																																																																																																																																																																																																																																																																								
TC	TERRA COTTA/TOP OR CURB																																																																																																																																																																																																																																																																																																																																																																																																																																																																																																																																																																																																																																																																																																																								
TZ	TERRAZZO																																																																																																																																																																																																																																																																																																																																																																																																																																																																																																																																																																																																																																																																																																																								
THK	THICK, THICKNESS																																																																																																																																																																																																																																																																																																																																																																																																																																																																																																																																																																																																																																																																																																																								
THRES	THRESHOLD																																																																																																																																																																																																																																																																																																																																																																																																																																																																																																																																																																																																																																																																																																																								
TPD	TOILET PAPER DISPENSER																																																																																																																																																																																																																																																																																																																																																																																																																																																																																																																																																																																																																																																																																																																								
TOL	TOLERANCE																																																																																																																																																																																																																																																																																																																																																																																																																																																																																																																																																																																																																																																																																																																								
T&G	TONGUE AND GROOVE																																																																																																																																																																																																																																																																																																																																																																																																																																																																																																																																																																																																																																																																																																																								
TOC	TOP OF CONCRETE																																																																																																																																																																																																																																																																																																																																																																																																																																																																																																																																																																																																																																																																																																																								
TOV	TOP OF EXT. MASONRY VENEER																																																																																																																																																																																																																																																																																																																																																																																																																																																																																																																																																																																																																																																																																																																								
TOF	TOP OF FINISH																																																																																																																																																																																																																																																																																																																																																																																																																																																																																																																																																																																																																																																																																																																								
TOM	TOP OF MASONRY																																																																																																																																																																																																																																																																																																																																																																																																																																																																																																																																																																																																																																																																																																																								
TOS	TOP OF STEEL																																																																																																																																																																																																																																																																																																																																																																																																																																																																																																																																																																																																																																																																																																																								
TOW	TOP OF WALL																																																																																																																																																																																																																																																																																																																																																																																																																																																																																																																																																																																																																																																																																																																								
TB & S	TOP, BOTTOM AND SIDES																																																																																																																																																																																																																																																																																																																																																																																																																																																																																																																																																																																																																																																																																																																								
T	TREAD																																																																																																																																																																																																																																																																																																																																																																																																																																																																																																																																																																																																																																																																																																																								
TRTD	TREATED																																																																																																																																																																																																																																																																																																																																																																																																																																																																																																																																																																																																																																																																																																																								
TWD	TREATED WOOD																																																																																																																																																																																																																																																																																																																																																																																																																																																																																																																																																																																																																																																																																																																								
TYP	TYPICAL																																																																																																																																																																																																																																																																																																																																																																																																																																																																																																																																																																																																																																																																																																																								
UC	UNDERCUT																																																																																																																																																																																																																																																																																																																																																																																																																																																																																																																																																																																																																																																																																																																								
UNFIN	UNFINISHED																																																																																																																																																																																																																																																																																																																																																																																																																																																																																																																																																																																																																																																																																																																								
UV	UNIT VENTILATOR																																																																																																																																																																																																																																																																																																																																																																																																																																																																																																																																																																																																																																																																																																																								
UON, UNO	UNLESS OTHERWISE NOTED																																																																																																																																																																																																																																																																																																																																																																																																																																																																																																																																																																																																																																																																																																																								
UR	URINAL																																																																																																																																																																																																																																																																																																																																																																																																																																																																																																																																																																																																																																																																																																																								
VAC	VACUUM																																																																																																																																																																																																																																																																																																																																																																																																																																																																																																																																																																																																																																																																																																																								
VA	VALVE																																																																																																																																																																																																																																																																																																																																																																																																																																																																																																																																																																																																																																																																																																																								
VB	VAPOR BARRIER																																																																																																																																																																																																																																																																																																																																																																																																																																																																																																																																																																																																																																																																																																																								
VAR	VARIABLE																																																																																																																																																																																																																																																																																																																																																																																																																																																																																																																																																																																																																																																																																																																								
VENT	VENTILATION																																																																																																																																																																																																																																																																																																																																																																																																																																																																																																																																																																																																																																																																																																																								
VIF	VERIFY IN FIELD																																																																																																																																																																																																																																																																																																																																																																																																																																																																																																																																																																																																																																																																																																																								
VERM	VERMICULITE																																																																																																																																																																																																																																																																																																																																																																																																																																																																																																																																																																																																																																																																																																																								
VERT	VERTICAL																																																																																																																																																																																																																																																																																																																																																																																																																																																																																																																																																																																																																																																																																																																								
VG	VERTICAL GRAIN																																																																																																																																																																																																																																																																																																																																																																																																																																																																																																																																																																																																																																																																																																																								
VEST	VESTIBULE																																																																																																																																																																																																																																																																																																																																																																																																																																																																																																																																																																																																																																																																																																																								
VB	VINYL BASE																																																																																																																																																																																																																																																																																																																																																																																																																																																																																																																																																																																																																																																																																																																								
VCT	VINYL COMPOSITION TILE																																																																																																																																																																																																																																																																																																																																																																																																																																																																																																																																																																																																																																																																																																																								
VVC	VINYL WALL COVERING																																																																																																																																																																																																																																																																																																																																																																																																																																																																																																																																																																																																																																																																																																																								
WH	WATER HEATER																																																																																																																																																																																																																																																																																																																																																																																																																																																																																																																																																																																																																																																																																																																								
WSTO	WATER STOP (@ CONC JOINT)																																																																																																																																																																																																																																																																																																																																																																																																																																																																																																																																																																																																																																																																																																																								
WP	WATERPROOF, WATERPROOFING																																																																																																																																																																																																																																																																																																																																																																																																																																																																																																																																																																																																																																																																																																																								
WSTRP	WEATHERSTRIP																																																																																																																																																																																																																																																																																																																																																																																																																																																																																																																																																																																																																																																																																																																								
WT	WEIGHT																																																																																																																																																																																																																																																																																																																																																																																																																																																																																																																																																																																																																																																																																																																								
WWF	WELDED WIRE FABRIC OR MESH																																																																																																																																																																																																																																																																																																																																																																																																																																																																																																																																																																																																																																																																																																																								
WO	WHERE OCCURS																																																																																																																																																																																																																																																																																																																																																																																																																																																																																																																																																																																																																																																																																																																								
WF	WIDE FLANGE																																																																																																																																																																																																																																																																																																																																																																																																																																																																																																																																																																																																																																																																																																																								
W	WASH, WASHER, WEST, WATER																																																																																																																																																																																																																																																																																																																																																																																																																																																																																																																																																																																																																																																																																																																								
WDW	WINDOW																																																																																																																																																																																																																																																																																																																																																																																																																																																																																																																																																																																																																																																																																																																								
WI	WITH																																																																																																																																																																																																																																																																																																																																																																																																																																																																																																																																																																																																																																																																																																																								
WO	WITHOUT																																																																																																																																																																																																																																																																																																																																																																																																																																																																																																																																																																																																																																																																																																																								
WD	WOOD																																																																																																																																																																																																																																																																																																																																																																																																																																																																																																																																																																																																																																																																																																																								
WB	WOOD BASE																																																																																																																																																																																																																																																																																																																																																																																																																																																																																																																																																																																																																																																																																																																								
WPT	WORKING POINT																																																																																																																																																																																																																																																																																																																																																																																																																																																																																																																																																																																																																																																																																																																								
WI	WROUGHT IRON																																																																																																																																																																																																																																																																																																																																																																																																																																																																																																																																																																																																																																																																																																																								
AND	AND																																																																																																																																																																																																																																																																																																																																																																																																																																																																																																																																																																																																																																																																																																																								
&	AT																																																																																																																																																																																																																																																																																																																																																																																																																																																																																																																																																																																																																																																																																																																								
@	ANGLE																																																																																																																																																																																																																																																																																																																																																																																																																																																																																																																																																																																																																																																																																																																								
<	BY																																																																																																																																																																																																																																																																																																																																																																																																																																																																																																																																																																																																																																																																																																																								
X	CENTERLINE																																																																																																																																																																																																																																																																																																																																																																																																																																																																																																																																																																																																																																																																																																																								
∩	EQUAL																																																																																																																																																																																																																																																																																																																																																																																																																																																																																																																																																																																																																																																																																																																								
=	POUND																																																																																																																																																																																																																																																																																																																																																																																																																																																																																																																																																																																																																																																																																																																								
#	PROPERTY LINE																																																																																																																																																																																																																																																																																																																																																																																																																																																																																																																																																																																																																																																																																																																								

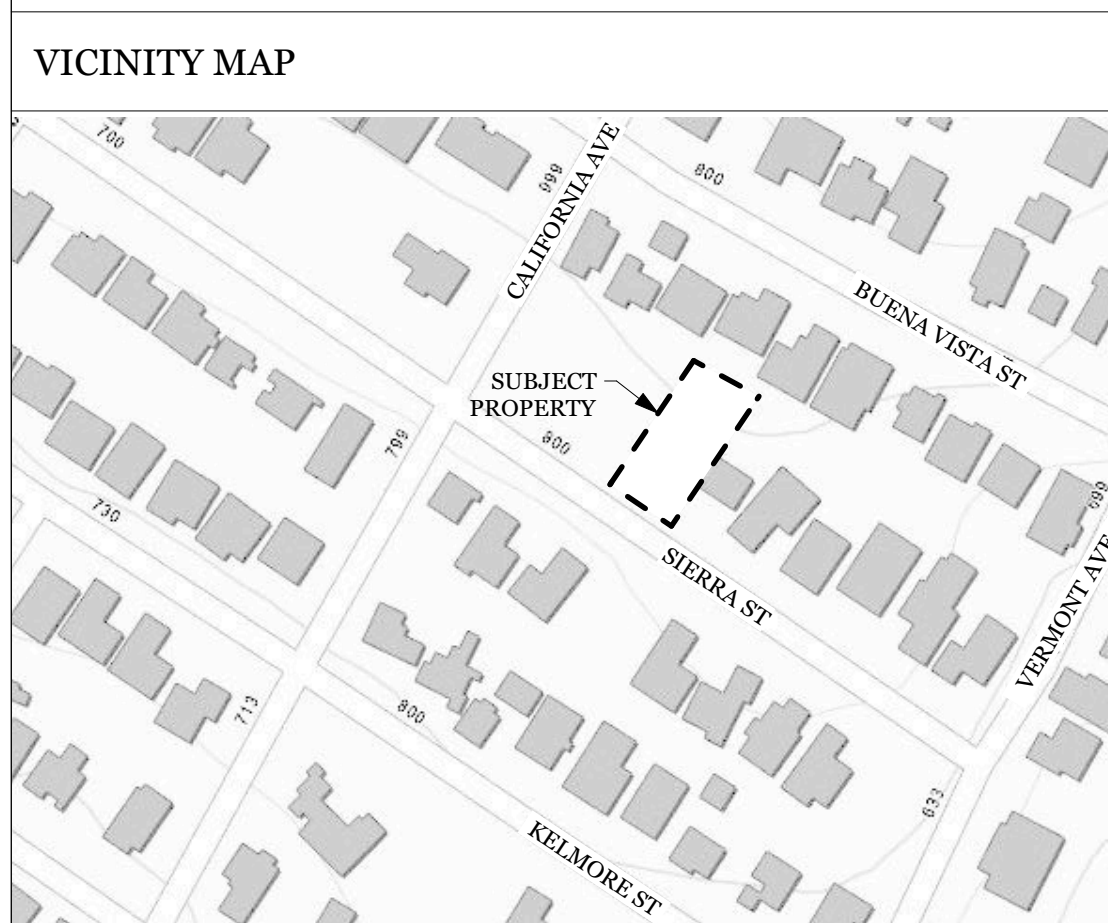

STRUCTURAL ENGINEER

CONTRACTOR



VICINITY MAP	
<p>UNITS: 1 (PROPOSED)</p> <p>ZONING: R-1/8-17/DR/CD</p> <p>STORIES: 2-STORY (PROPOSED)</p> <p>YEAR BUILT: N/A</p> <p>USE: R3</p> <p>LOT & BLOCK/AFN: 037-147-030</p> <p>CONSTRUCTION TYPE: V-B</p> <p>CLIMATE ZONE: 3</p> <p>WUI: NON-VHFHSZ</p>	
<p>(P) MAIN HOUSE SQFT:</p> <p>1ST LEVEL: 1213 SQ.FT.</p> <p>2ND LEVEL: 1033 SQ. FT.</p> <p>(P) MAIN HOUSE SQFT: 2246 SQ.FT.</p> <p>(P) GARAGE: 576SQ. FT.</p>	
<p>(P) BUILDING HEIGHT: 27'-1"</p> <p>BUILDING FOOTPRINT SLOPE: 12.2%</p>	
<p>MAX PARCEL COVERAGE: 35% = 2,008.5 SQ.FT.</p> <p>(E) LOT SQ. FT.: 5,738.7 SQ. FT.</p> <p>(P) PARCEL COVERAGE: 1,969 SQ. FT.</p>	
<p>MAX FLOOR AREA RATIO: 53% = 3,041 SQ. FT.</p> <p>(E) LOT SQ. FT.: 5,738.7 SQ. FT.</p> <p>(P) FAR: 2,822 SQ. FT. = 49</p>	
<p>MAX. IMPERVIOUS SURFACE AREA: 10% OF 5,738.7 SQ. FT. = 573.9 SQ. FT.</p> <p>(P) IMPERVIOUS SURFACE AREA: 453 SQ. FT.</p>	
<p>*FRONT YARD: 20'-0" SETBACK</p> <p>*REAR YARD: 20'-0" SETBACK</p> <p>*SIDE YARD: 15'-0" SETBACK COMBINE TOTAL MIN. 5'-0" ON ANY SIDE</p> <p>*BLDG HT MAX (UP TO 30% SLOPE): 28'-0" (PROJECTED NATURAL GRADE)</p>	
<p>CIVIL ENGINEER: SURVEYOR:</p> <p>UPRIGHT ENGINEERING BGT LAND SURVEYING</p> <p>3641 MT. DIABLO BLVD #1841 1206 S. AMPHILLETTE BLVD., SUITE 3</p> <p>LAFAYETTE, CA 94549 SAN MATEO, CA 94402</p> <p>(925)-275-5304 (650)-212-1030</p> <p>austin@uprightengineering.com www.bgtssurveying.com</p>	
<p>GEOTECHNICAL ENGINEER: ARBORIST:</p> <p>HARO, KASUNICH & ASSOCIATES PRECISION TREE CARE</p> <p>116 EAST LAKE AVE PO BOX 410</p> <p>WATSONVILLE, CA 95076 PACIFICA, CA 94044</p> <p>(831)-722-4175 (650)-355-1277</p>	
<p>STRUCTURAL ENGINEER:</p> <p>BCA STRUCTURAL ENGINEERING, INC.</p> <p>1300 INDUSTRIAL ROAD, SUITE 1</p> <p>SAN CARLOS, CA 94070</p> <p>(650)-958-2500</p> <p>geoff@bcaceng.net</p>	

DRAWING INDEX	
A.0.0	TITLE SHEET
A.1.0	EXISTING & PROPOSED SITE/ ROOF PLANS
A.1.1	LANDSCAPE & HARDSCAPE PLAN
A.2.1	FLOOR PLANS
A.2.2	FLOOR PLANS
A.3.0	EXTERIOR ELEVATIONS
A.3.1	EXTERIOR ELEVATIONS
A.4.1	PROPOSED SECTION
C.1.0	COVER SHEET
C.2.0	GRADING AND EROSION CONTROL
C.3.0	DRAINAGE
C.4.0	UTILITIES
C.5.0	DETAILS
SU.1	SURVEY

SCOPE OF WORK	
-	NEW 2 STORY SINGLE FAMILY HOME WITH GARAGE
-	NEW KITCHENS, BATHROOMS, BEDROOMS, CLOSETS, FIREPLACE, FOUNDATION, RETAINING WALLS, DRIVEWAY

PROJECT NARRATIVE

Since the last design review, we have converted the plans from modular build to custom in order to improve and optimize the design with respect to neighborhood stewardship, esthetic integrity, and energy efficiency.

First, to the specific requests made by the panel at the previous review: Articulation has been added to both of the side walls, as well as the front of the house, by use of small push-outs on either side, and terraced decks on the front that echo the natural upslope of the property and neighborhood block itself. The facade will feature a combination of integral color smooth stucco and horizontal wood, for texture and depth, which is both in keeping with the modern esthetic of the design, and is reminiscent of the natural colors and textures of the coastal region. The push-out articulation is visually balanced, without being simply symmetric, by the use of the facade textures and features such as the stairs and clerestory. Further interest and balance is added by the parapet roof details.

The primary first floor deck has been pushed forward over the garage, while the garage itself has been moved closer to the midline and front of the lower story of the house, to maximize use of the natural upslope, and allow the garage to appear more integral and intentional, rather than jutting out from the primary house.

The placement of this house is slightly forward compared to the neighboring house to the South, with a goal to allow passive lighting through Southward windows while still maintaining privacy for the neighbors and ourselves. The house placement remains to the slight South of the lot, which better maintains the natural drainage through the topographically lowest area of the landscape, and reduces the shadow this house would cast over property that could be developed to the North.

The footprint of the house has been slightly reduced by more closely incorporating the garage into the foundation of the main house. The flat roof, which may read as fully flat from the street but is slightly sloped downward in the same direction of the topography, combined with an overall slight lowering of the upper ceiling, will reduce the apparent size as well as the impact on neighbors' ocean views.

The remaining tree on the property (after its slightly less healthy partner collapsed since the previous arboreal review) will be removed, as a house foundation would compromise its root system. This will further open ocean views in the neighborhood, and that tree will be replaced with several smaller trees, to allow for landscaping design that will maximize beauty and privacy, while reducing the risk that the remaining large tree could also collapse and cause damage to any nearby structures.

The primary living spaces of the great rooms have been moved to the southwest side of the house, with large street-facing windows, and this is combined with multiple 2nd story skylights to allow for extensive passive lighting and heating capacity throughout the house. We have maintained the basic structure of the previously reviewed design for energy and engineering/material efficiency. While the internal

M&H PROPERTIES
VACANT LOT, SIERRA ST.
MOSS BEACH, CA 94038
APN: 037-147-160



Stamp

NO DATE ISSUES/REVISIONS

LANDSCAPE AND HARDSCAPE PLAN

DRAWN BY: RLM SHEET SIZE: 24 X 36

SCALE IN FEET: 1/8" = 1'-0" X

Drawing No. **A-1.1**

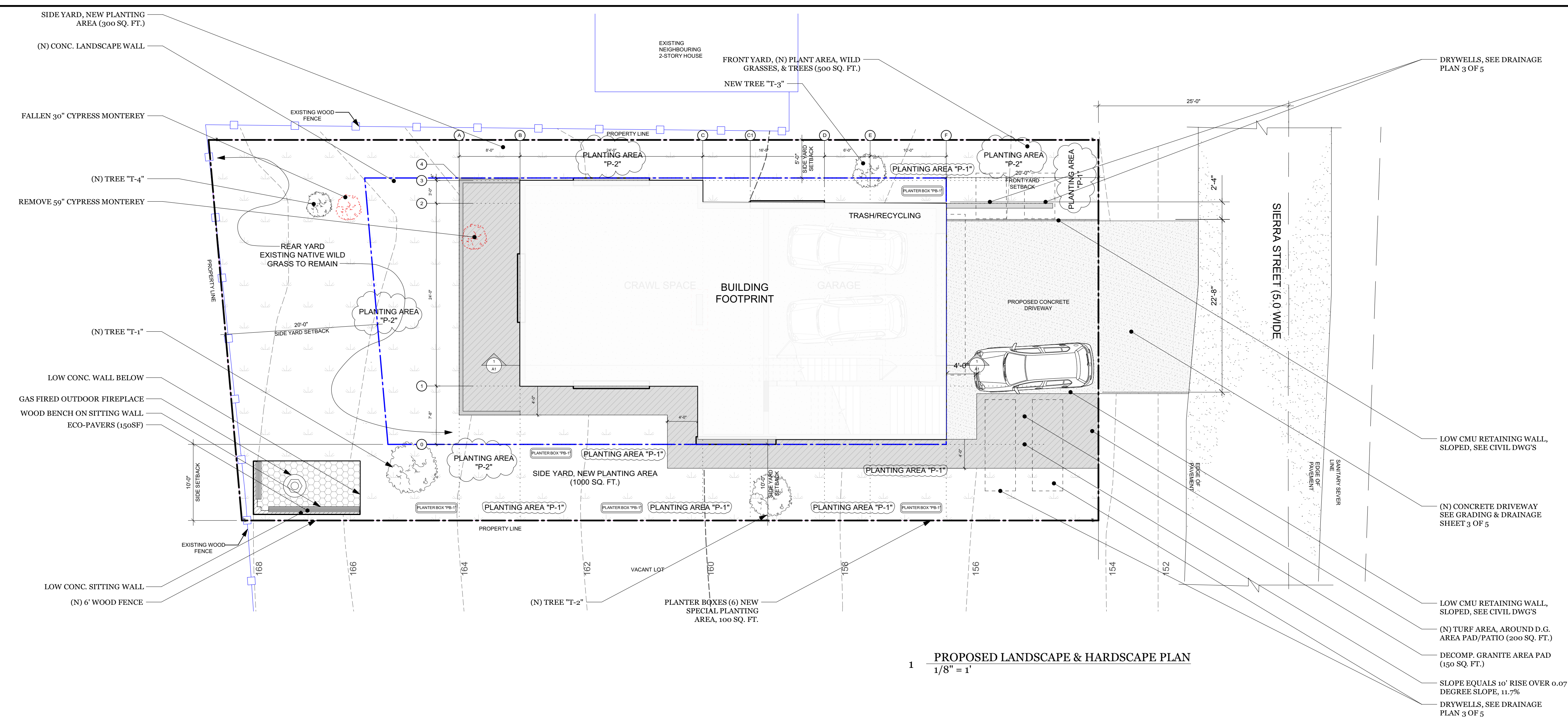

1 PROPOSED LANDSCAPE & HARDSCAPE PLAN
1/8" = 1'

GENERAL NOTE:

- HAND WATER LANDSCAPE
- MINIMIZE THE HARDSCAPE OR IMPERVIOUS AREAS ON-SITE IN ORDER TO MAXIMIZE PERMEABLE SURFACES THAT REDUCE THE VOLUME AND IMPROVE THE QUALITY OF RUN-OFF INTO CREEKS AND STORM DRAINS

PLANT MATERIAL NOTE:

- A MIN. 3 INCH LAYER OF MULCH SHALL BE APPLIED ON ALL EXPOSED SOIL SURFACES OF PLANTING AREAS EXCEPT TURF AREAS CREEPING OR ROOTING GROUNDCOVERS, OR DIRECT SEEDING APPLICATIONS WHERE MULCH IS CONTRAINDICATED

TURF NOTES:

- THE TOTAL TURF AREA SHALL NOT EXCEED 25% OF THE LANDSCAPE AREA IN RESIDENTIAL AREAS
- NO TURF PERMITTED IN NON-RESIDENTIAL AREAS
- TURF NOT PERMITTED ON SLOPES GREATER THAN 25%
- TURF IS PROHIBITED IN PARKWAYS LESS THAN 10 FT. WIDE

IRRIGATION SYSTEM REQUIREMENTS:

- IRRIGATION CONTROLLERS PROGRAMMING DATA WILL NOT BE LOST DUE TO AN INTERRUPTION IN THE PRIMARY POWER SOURCE

PLANT WATER USE:

- INSTALL CLIMATE ADAPTED PLANTS THAT REQUIRE OCCASIONAL, LITTLE, OR NO SUMMER WATER (AVERAGE WUCOLS PLANT FACTOR 0.3) FOR 75% OF THE PLANT AREA EXCLUDING EDIBLES & AREAS USING RECYCLED WATER

LOT COVERAGE TABULATIONS

TOTAL TURF AREA	0 SQ. FT. (<MAX ALLOWABLE TURF AREA: 525 SQ. FT.)
TOTAL PLANT AREA (NON-TURF)	2,000 SQ. FT.
TOTAL SPECIAL LANDSCAPE	100 SQ. FT. (= 6 OF PLANTER BOX)
TOTAL LANDSCAPE AREA	2,100 SQ. FT.

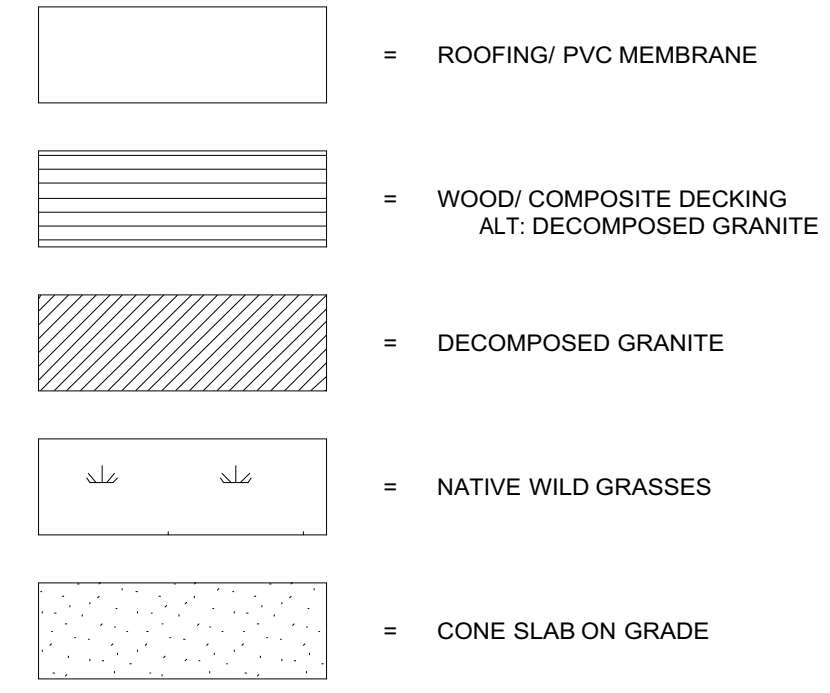

PLANT LIST - PLANTING BED AREAS:					
TYPE	COMMON NAME	BOTANICAL NAME	LOCATION	WATER USE	QUANTITY
P-1 PLANT IN A GROUP					
	AGAVES 1-4' BLUE GREEN	AGAVE AMERICAN	ALONG PLANT	VL	7 - 0.1 avg.
	WISTERIA	WISTERIA SPP	ALONG FENCE & CLIMBING TRELLIS	M	15 - 0.5 avg.
	BLUE FESCUE	FESTUCA GLAUCA	PLANTER BED	L	20 - 0.2 avg.
	GOLDEN PRIVETA	LIGUSTRUM X VICARYI	PLANTER BED	L	15 - 0.2 avg.
P-2					
	FLATS OF MYOPORUM	MYOPORUM PARVIFOLIUM	SLOPE	L	72 - 0.2 avg.
• PROJECT HARDINESS ZONE: 9-10 (MOSS BEACH, CA 94038)					
• AVERAGE WUCOLS FACTOR: = 0.23 avg.					

TREE PLANTING LIST:					
TYPE	COMMON NAME	BOTANICAL NAME	LOCATION	WATER USE	QUANTITY
T-1	GOLDN MEDALLION	CASSIA LEPTOPHYLLIA	SEE PLAN	L	1 - 0.2 avg.
T-2	DESERT WILLOW	CHILOPSIS LINEARIS	SEE PLAN	L	1 - 0.2 avg.
T-3	CRAPE MYRTLE	MYRTLE LAGERSTROEMIA INDICA	SEE PLAN	L	1 - 0.2 avg.
T-4	CHINESE PISTACHE	PISTACIA CHINENSIS	SEE PLAN	L	1 - 0.2 avg.
• PROJECT HARDINESS ZONE: 9-10 (MOSS BEACH, CA 94038)					
• AVERAGE WUCOLS FACTOR: [(4 X 0.2) / 4] (TOTAL NUMBER PLANT) = 0.200 avg.					

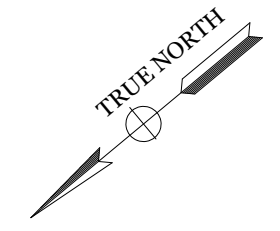

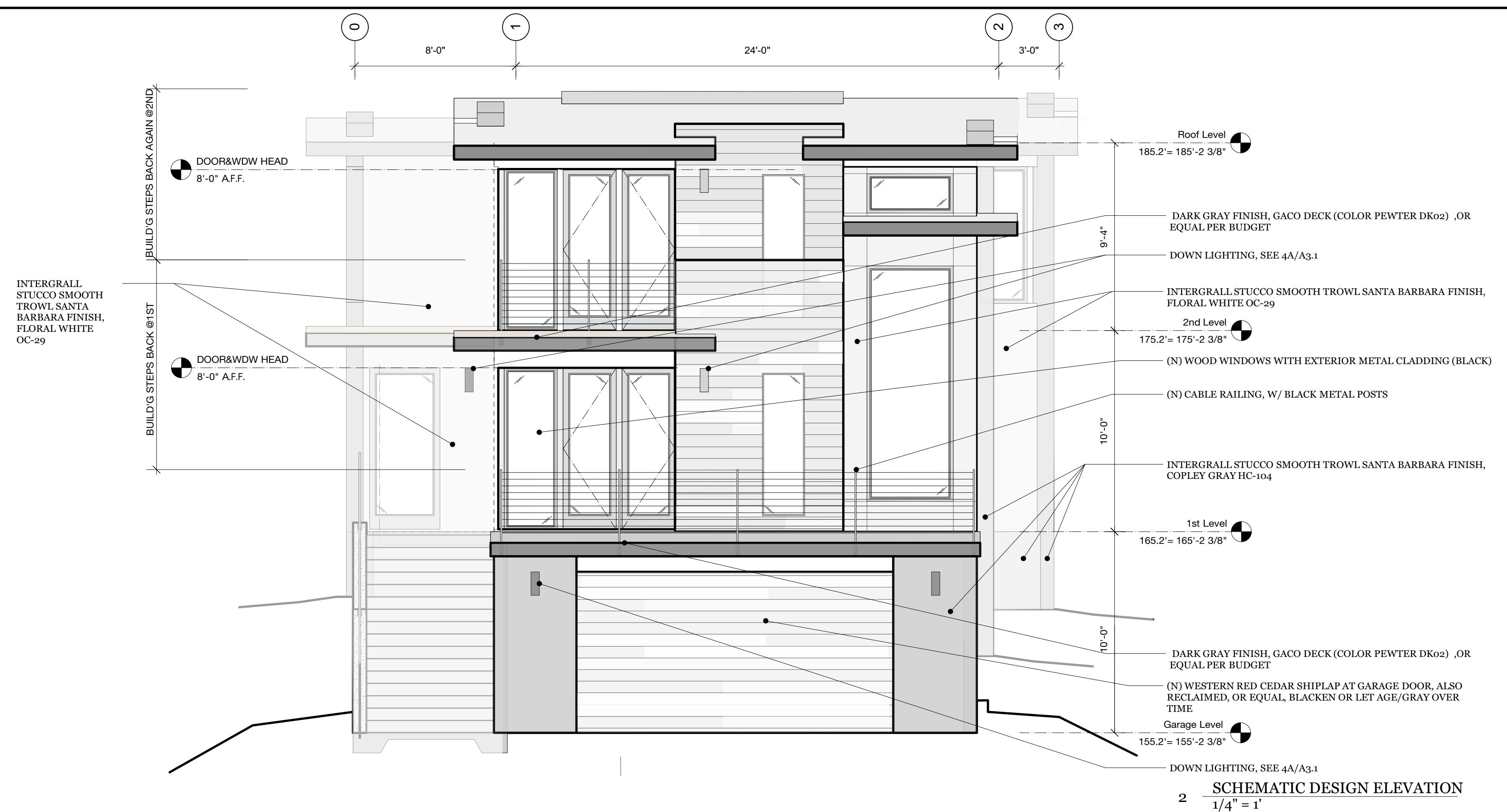

2 SCHEMATIC DESIGN ELEVATION
1/4" = 1'

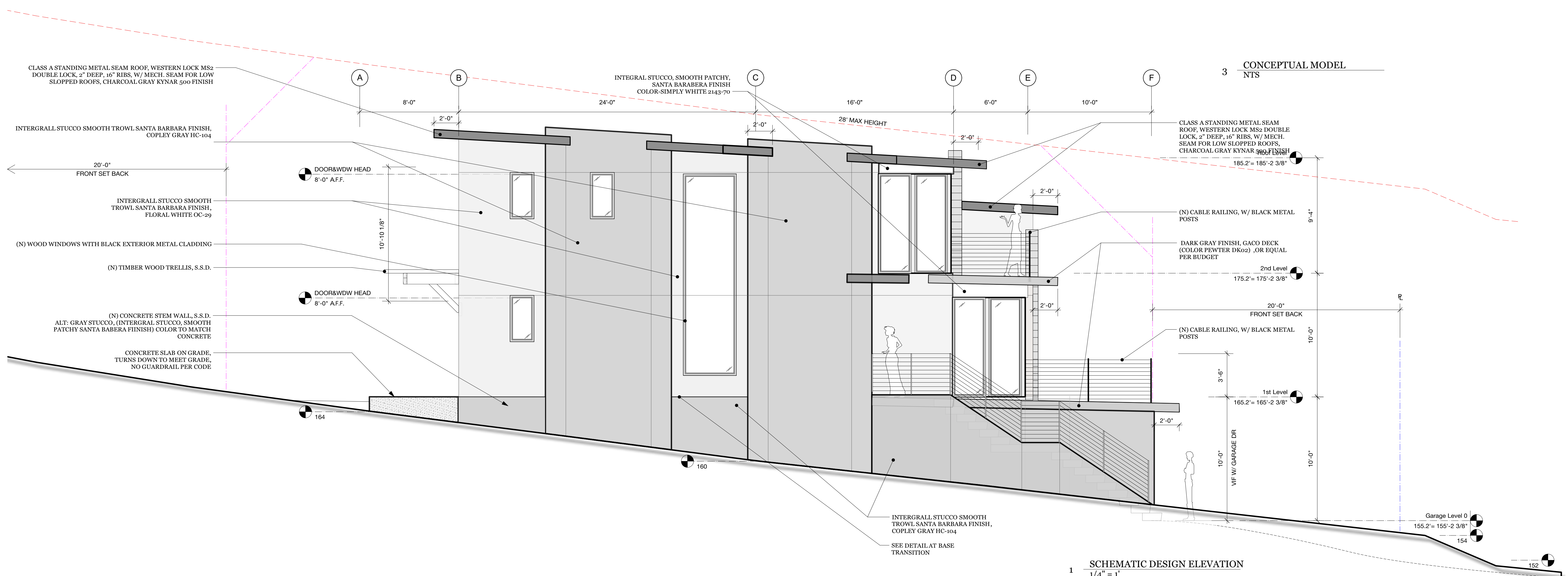

1 SCHEMATIC DESIGN ELEVATION
1/4" = 1'

3 CONCEPTUAL MODEL
NTS

M&H PROPERTIES
VACANT LOT, SIERRA ST.
MOSS BEACH, CA 94038
APN: 037-147-160



Stamp

07-14-21 PERMIT SET PLNG ZNG
NO DATE ISSUES/REVISIONS

EXTERIOR ELEVATIONS

DRAWN BY: JJS SHEET SIZE: 24 X 36
SCALE IN FEET: 1/16" = 1'-0" X

Drawing No. **A-3.0**

M&H PROPERTIES
 VACANT LOT, SIERRA ST.
 MOSS BEACH, CA 94038
 APN: 037-147-160

Vertical Scale: 1/4" = 1'



Stamp

07-14-21 PERMIT SET PLNG ZNG

NO DATE ISSUES/REVISIONS

PROPOSED SECTION

DRAWN BY: JJS SHEET SIZE: 24 X 36

SCALE IN FEET: 1/16" = 1'-0" X

Drawing No. **A-4.0**

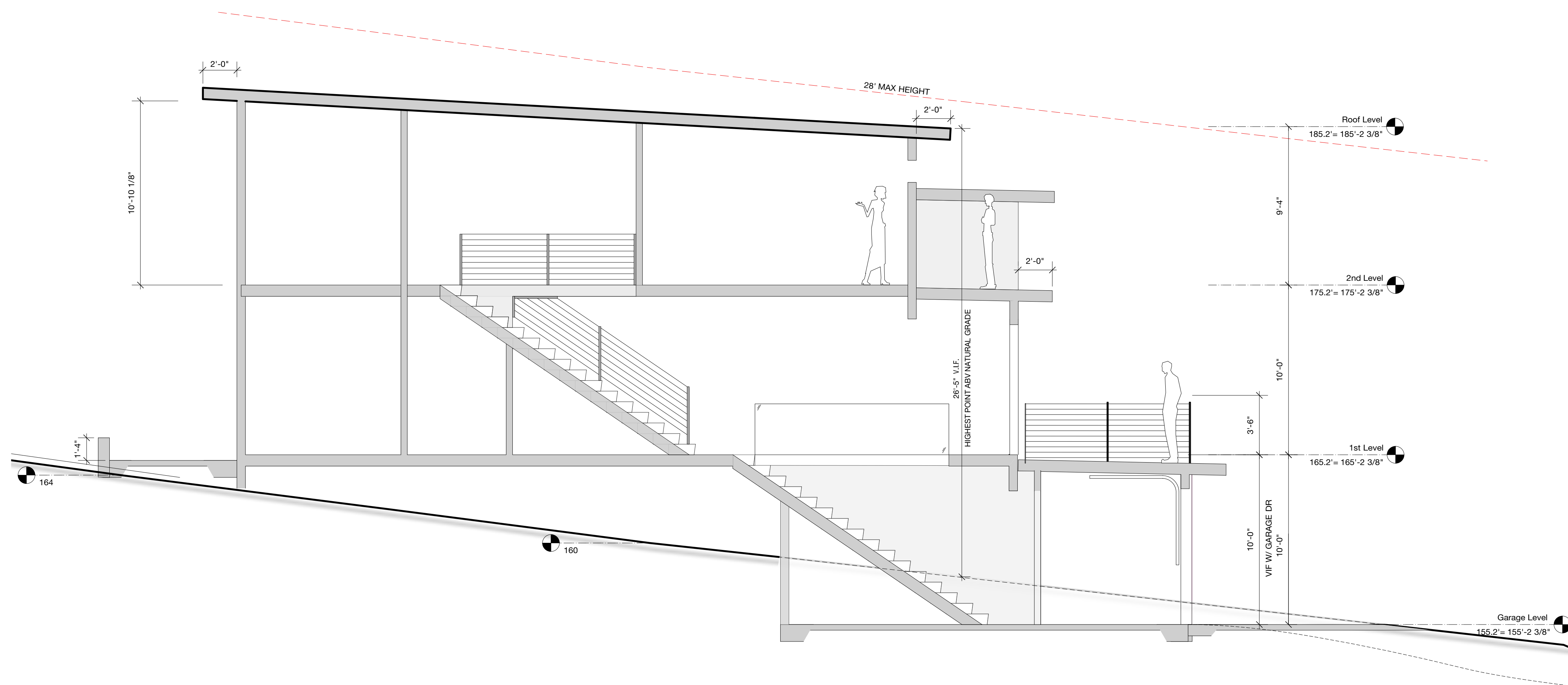

1 SCHEMATIC DESIGN SECTION
 1/4" = 1'

NEW RESIDENCE

VACANT LOT, SIERRA ST, MOSS BEACH, CA

APN# 037-147-030

GRADING & DRAINAGE PLAN

LOCATION MAP

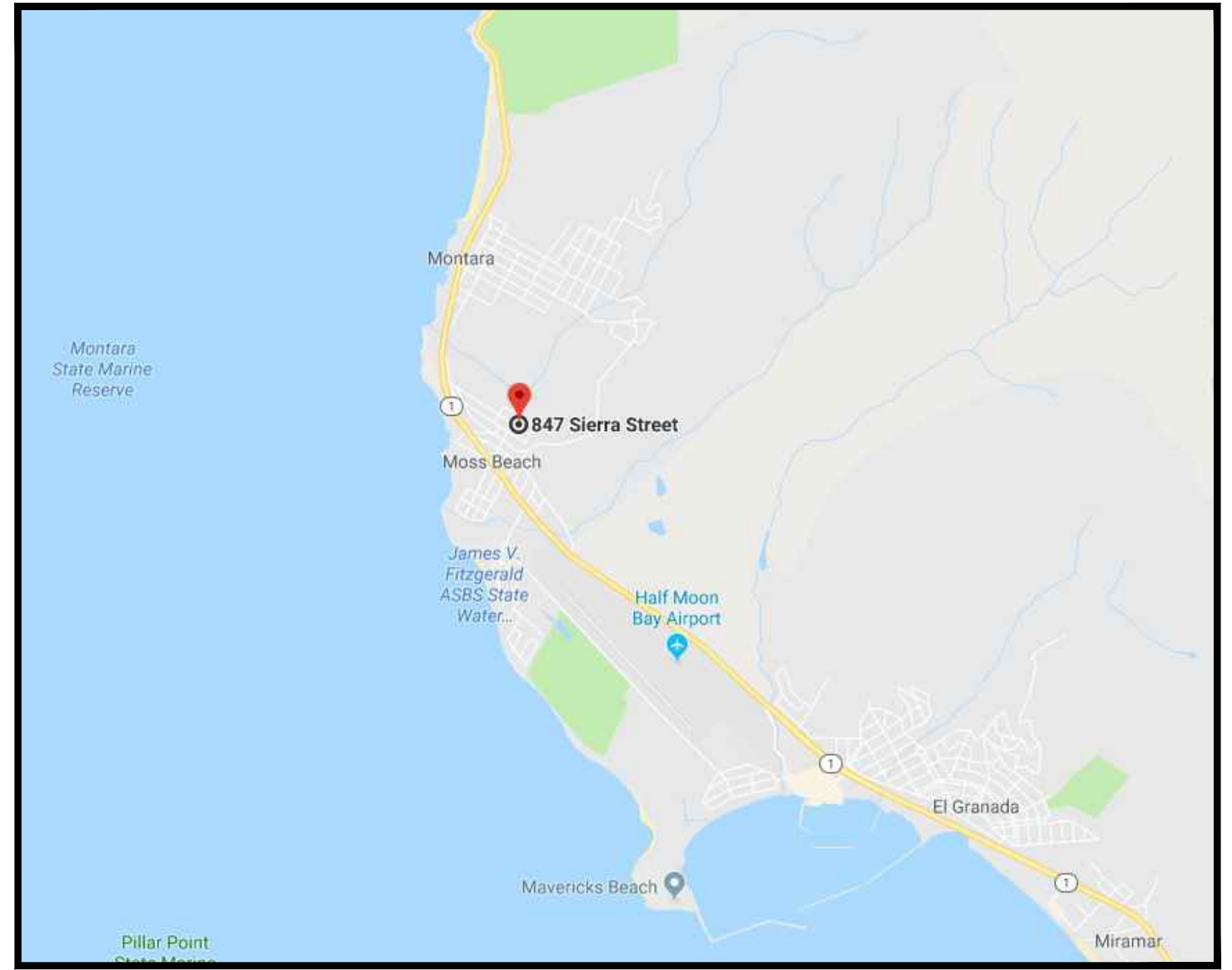

NOT TO SCALE

SURVEY DATUM

Topographic survey was provided by BGT Land Surveying per the Boundary and Topographic Survey dated June, 2018.

MAP DATA

Contour Interval: 2 Foot (existing contours), 1 Foot (proposed contours)

Aerial Photo: None

SHEET INDEX

1	COVER SHEET
2	GRADING PLAN
3	DRAINAGE PLAN
4	UTILITY PLAN
5	DETAILS

GENERAL NOTES

- THESE ENGINEERING DRAWINGS ARE BASED ON CONDITIONS AT THE TIME OF DESIGN AND FROM INFORMATION PROVIDED BY THE OWNER. FUTURE MODIFICATIONS TO GRADING AND SITE DEVELOPMENT COULD CAUSE EROSION AND LATERAL MOVEMENT OF THE GRADING.
- ALL GRADING SHALL CONFORM TO THE RECOMMENDATIONS OF THE PROJECT GEOTECHNICAL AND/OR THE PROJECT SOIL ENGINEER.
- OBSERVATION OF THE CONSTRUCTION BY THE ENGINEER DOES NOT RELIEVE THE CONTRACTOR FROM RESPONSIBILITY TO COMPLETE THE CONSTRUCTION IN CONFORMANCE WITH THE PROJECT DOCUMENTS AND GENERALLY ACCEPTED STANDARDS OF PRACTICE. THE PURPOSE OF THE ENGINEERS VISITS WILL BE TO BECOME GENERALLY FAMILIAR WITH THE PROGRESS AND QUALITY OF THE CONTRACTOR'S WORK AND DETERMINE IF THE WORK IS PROGRESSING IN GENERAL CONFORMANCE WITH OUR DESIGN INTENT.

GENERAL STORMWATER NOTES

- STOCKPILES: ALL STOCKPILES ASSOCIATED WITH THE PROJECT SHALL BE COVERED WITH PLASTIC SHEETING PRIOR TO ANY PRECIPITATION EVENT TO PREVENT RUNOFF OF SEDIMENT. SHEETING SHALL BE FIRMLY HELD IN PLACE WITH SANDBAGS OR OTHER WEIGHTS PLACED NO MORE THAN 10FT APART. SEAMS SHALL BE TAPED OR WEIGHTED DOWN THEIR ENTIRE LENGTH AND THERE SHALL BE AT LEAST A 12 INCH OVERLAP.
- DUST CONTROL: BEST MANAGEMENT PRACTICES SHALL BE USED THROUGHOUT ALL PHASES OF CONSTRUCTION. THIS INCLUDES ANY SUSPENSION OF WORK, ALLEVIATION OR PREVENTION OF ANY FUGITIVE DUST NUISANCE AND THE DISCHARGE OF SMOKE OR ANY OTHER AIR CONTAMINANTS INTO THE ATMOSPHERE IN SUCH QUANTITY AS WILL VIOLATE ANY REGIONAL AIR POLLUTION CONTROL RULES, REGULATIONS, ORDINANCES, OR STATUTES. WATER SHALL BE APPLIED AS REQUIRED. DUST NUISANCE SHALL ALSO BE ABATED BY CLEANING, VACUUMING AND SWEEPING OR OTHER MEANS AS NECESSARY.
- INTERIM EROSION AND SEDIMENT CONTROL: THIS PLAN INCLUDES INTERIM EROSION AND SEDIMENTATION CONTROL MEASURES TO BE TAKEN DURING WET SEASONS UNTIL PERMANENT EROSION AND SEDIMENTATION CONTROL MEASURES CAN ADEQUATELY MINIMIZE EROSION, EXCESSIVE STORM WATER RUNOFF AND SEDIMENTATION. THIS PLAN INCLUDES THE MINIMUM NECESSARY MEASURES TO BE TAKEN TO PREVENT EXCESSIVE STORM WATER RUNOFF OR CARRYING BY STORM WATER RUNOFF OF SOLID MATERIALS ON TO LANDS OF ADJACENT PROPERTY OWNERS, PUBLIC STREETS, OR TO WATERCOURSES AS A RESULT OF CONDITIONS CREATED BY GRADING OPERATIONS. ADDITIONAL MEASURES MAY BE REQUIRED IF DETERMINED BY THE CONTRACTOR, THE CITY, THE COUNTY, OR THE ENGINEER AS CHANGING CONDITIONS OCCUR. GRADING SHALL NOT TAKE PLACE DURING THE RAINY SEASON WITHOUT THE IMPLEMENTATION OF ADDITIONAL BMP'S TO PREVENT EROSION AND RUNOFF.
- PERMANENT EROSION AND SEDIMENT CONTROL: PERMANENT EROSION AND SEDIMENT CONTROL SHALL BE PROVIDED BY LANDSCAPING OF DISTURBED AREAS OF THE PROJECT SITE. LANDSCAPING SHALL CONSIST OF SOME OR AL THE FOLLOWING: SPREADING OF MULCH, SEEDING, AND PLANTING OF CONTAINER PLANTS. ANTICIPATED TIME UNTIL ESTABLISHMENT FOR THESE 3 LANDSCAPING METHODS IS AS FOLLOWS: IMMEDIATE, 3 MONTHS, 1 MONTH (RESPECTIVELY), ASSUMING APPROPRIATE IRRIGATION IS PROVIDED. DOWNSPOUTS SHALL BE DIRECTED INTO THE UNDERGROUND DRAINAGE SYSTEM AS INDICATED ON THE DRAINAGE PLAN OR AWAY FROM STRUCTURES.
- PROJECT SHALL CONFORM TO THE SAN MATEO COUNTY "DRAINAGE MANUAL DRAFT" DOCUMENT DATED DECEMBER 2019.
- THIS PROJECT WILL DISPERSE ALL RUNOFF FROM ROOFS AND HARDSCAPE AREAS TO APPROPRIATE LOCATIONS AND AS SHOWN ON THE PLANS.
- STORMWATER DISCHARGE ADJACENT TO FOUNDATIONS AND OTHER STRUCTURES IS NOT PERMITTED.



REV. NO.	DESCRIPTION	DATE	APPROVED
1	REVISED SITE PLAN	7/09/2021	
2	ADDRESSED COMMENTS FROM COUNTY DPW 8-6-2020	8/13/2020	
3	REVISED DRAINAGE AND STORMWATER BMP'S	4/24/2020	
4	ADDRESSED COMMENTS FROM COUNTY 10/25/2019	11/5/2019	

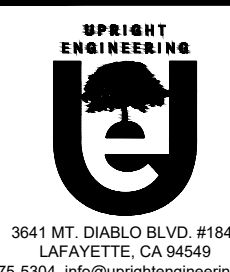

3641 MT. DIABLO BLVD. #841
LAFAYETTE, CA 94549
925-275-5304 info@sprintengineeringinc.com

PERMIT SET	
DATE: 7/9/2021	DESIGNED BY: MEL
NEW RESIDENCE	DRAWN BY: MEL
APN# 037-147-030	SURVEYED BY: BGT
SIERRA ST, MOSS BEACH, CA	CHECKED BY: AP
COVER SHEET	SHEET NO.
	1 OF 5

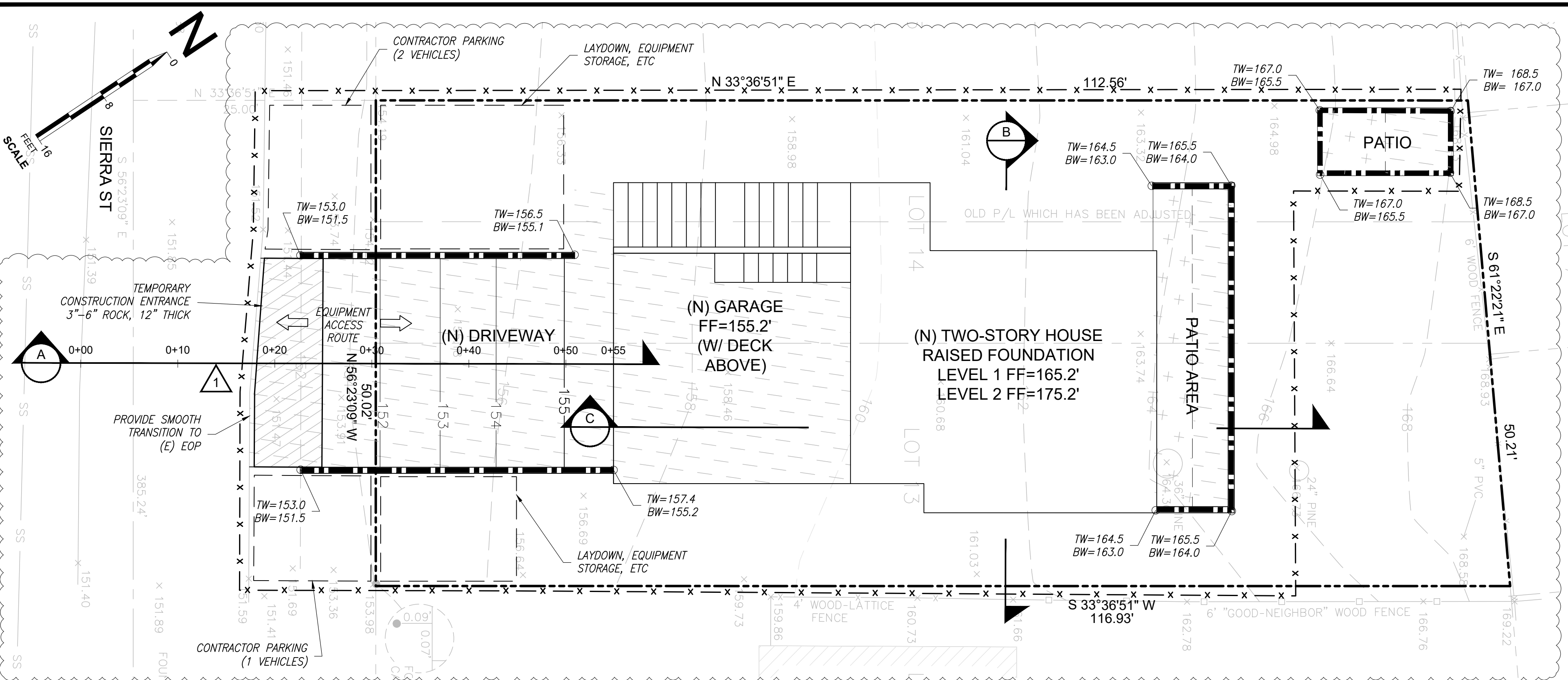

GRADING PLAN

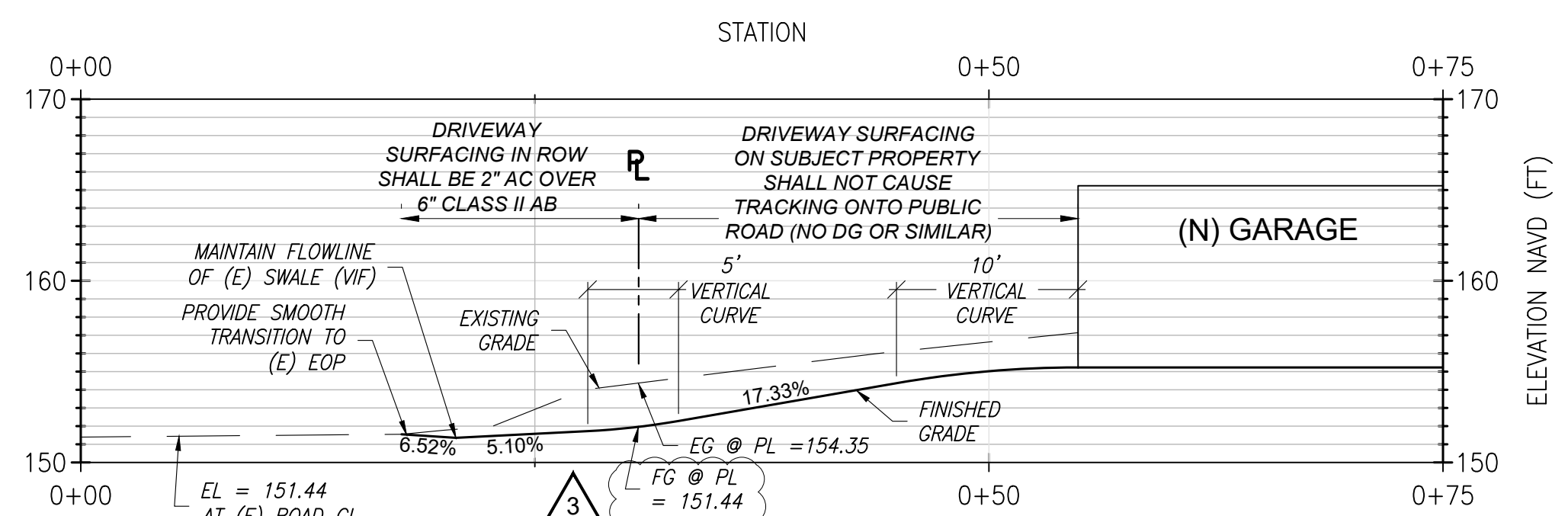

DRIVEWAY CL SECTION

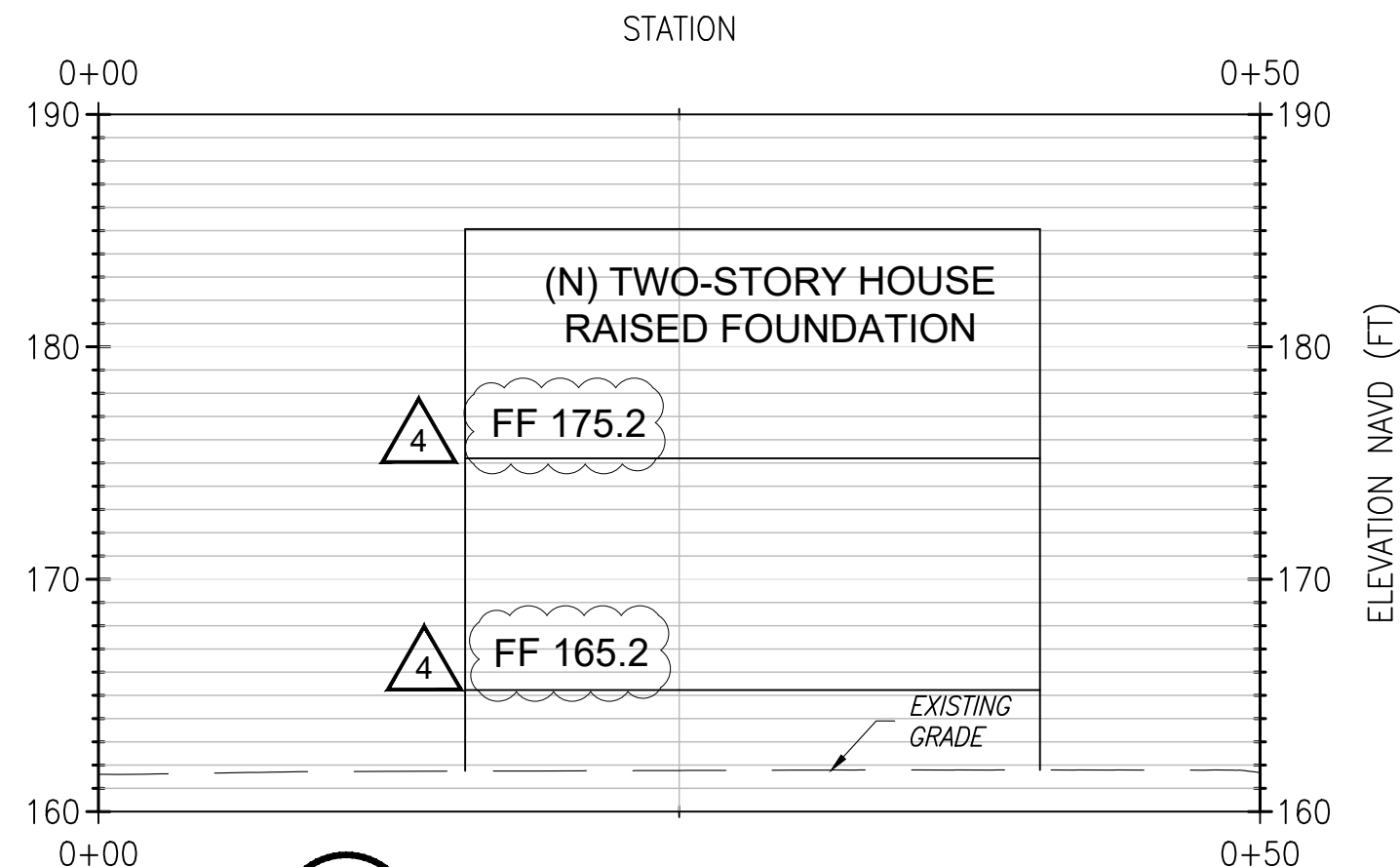

TYPICAL SECTION B

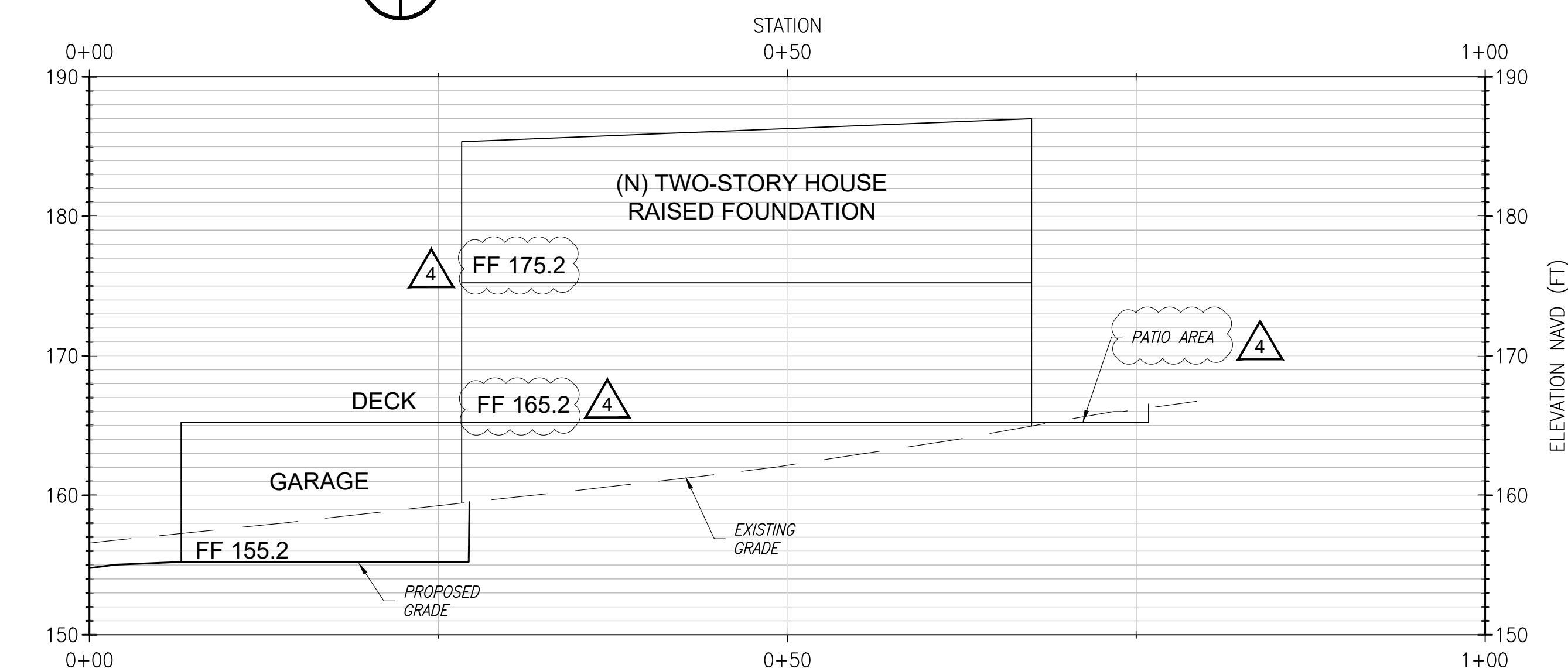

TYPICAL SECTION C

LEGEND AND KEY

- EXISTING MINOR CONTOUR
- EXISTING MAJOR CONTOUR
- EXISTING TOPO POINTS
- PROPOSED FILL
- PROPOSED CUT
- PROPERTY LINE
- PROPOSED STRAW WATTLE PER DETAIL 1 THIS SHEET
- PROPOSED LANDSCAPE WALL
- FL = FLOW LINE
- TC = TOP OF CURB
- BW = BACK OF SIDEWALK
- FG = FINISHED GRADE
- EOP = EDGE OF PAVEMENT
- VIF = VERIFY IN FIELD
- (E) = EXISTING
- (N) = PROPOSED

CUT/FILL TABLE			
ELEMENT	FILL (CY)	CUT (CY)	NET (CY)
DRIVEWAY	0	-52	-52
HOUSE	0	-63	-63
NET	0	-115	-115
TOTAL DISTURBED AREA: 5,600 SF			

GRADING NOTES

1. LOCATION OF CUTS AND FILLS ARE APPROXIMATE. CONTRACTOR TO VERIFY GRADING EXTENTS IN THE FIELD.
2. ALL GRADING SHALL BE PERFORMED PER THE RECOMMENDATIONS IN THE GEOTECHNICAL STUDY AND STRUCTURAL DRAWINGS.
3. CONTRACTOR SHALL CONSTRUCT DRAINAGE IMPROVEMENTS PRIOR TO GRADING TO PREVENT RUN-ON TO WORK AREA. IF IT IS NOT FEASIBLE TO CONSTRUCT DRAINAGE PRIOR TO GRADING, TEMPORARY DRAINAGE FACILITIES SHALL BE PROVIDED BY THE CONTRACTOR.
4. MAXIMUM FILL SLOPE SHALL BE 2:1 (HORIZ:VERT)
5. MAXIMUM CUT SLOPE SHALL BE 1.5:1 (HORIZ:VERT)

CONSTRUCTION STORMWATER BEST MANAGEMENT PRACTICES (BMP) NOTES:

1. EROSION CONTROL POINT OF CONTACT:
 - NAME: _____
 - TITLE/QUALIFICATION: _____
 - EMAIL: _____
 - PHONE NUMBER: _____
2. CLEARING AND EARTH-MOVING ACTIVITIES SHALL ONLY BE PERFORMED DURING DRY WEATHER. MEASURES TO ENSURE ADEQUATE EROSION AND SEDIMENT CONTROL SHALL BE INSTALLED PRIOR TO EARTH-MOVING ACTIVITIES AND CONSTRUCTION.
3. MEASURES TO ENSURE ADEQUATE EROSION AND SEDIMENT CONTROL ARE REQUIRED YEAR-ROUND. ALL DENUDEED AREAS SHALL BE STABILIZED AND EROSION CONTROL MEASURES CONTINUOUSLY MAINTAINED BETWEEN OCTOBER 1 AND APRIL 30.
4. CONSTRUCTION MATERIALS AND WASTES SHALL BE PROPERLY STORED, HANDLED, AND DISPOSED OF, SO AS TO PREVENT THEIR CONTACT WITH STORMWATER.
5. THE DISCHARGE OF ALL POTENTIAL POLLUTANTS, INCLUDING PAVEMENT CUTTING WASTES, PAINTS, CONCRETE, PETROLEUM PRODUCTS, CHEMICALS, WASH WATER OR SEDIMENTS, AND NON-STORMWATER DISCHARGES SHALL BE CONTROLLED AND PREVENTED TO STORM DRAINS AND WATERCOURSES.
6. SEDIMENT CONTROLS OR FILTRATION TO REMOVE SEDIMENT SHALL BE USED WHEN DEWATERING SITE AND REGIONAL WATER QUALITY CONTROL BOARD (RWQCB) PERMIT(S) SHALL BE OBTAINED AS NECESSARY.
7. CLEANING, FUELING, OR MAINTAINING VEHICLES ON-SITE SHALL NOT BE PERMITTED, EXCEPT IN A DESIGNATED AREA WHERE WASH WATER IS CONTAINED AND TREATED.
8. LIMIT AND TIME APPLICATIONS OF PESTICIDES AND FERTILIZERS TO PREVENT POLLUTED RUNOFF.
9. LIMIT CONSTRUCTION ACCESS ROUTES TO STABILIZED, DESIGNATED ACCESS POINTS.
10. AVOID TRACKING DIRT OR OTHER MATERIALS OFF-SITE; CLEAN OFF-SITE PAVED AREAS AND SIDEWALKS USING DRY SWEEPING METHODS.
11. TRAIN AND PROVIDE INSTRUCTION TO ALL EMPLOYEES AND SUBCONTRACTORS REGARDING THE WATERSHED PROTECTION MAINTENANCE STANDARDS AND CONSTRUCTION BEST MANAGEMENT PRACTICES.
12. PLACEMENT OF EROSION CONTROL MATERIALS AT THESE LOCATIONS ARE REQUIRED ON WEEKENDS AND DURING RAIN EVENTS: PER EROSION CONTROL PLAN.
13. THE AREAS DELINEATED ON THE PLANS FOR PARKING, GRUBBING, STORAGE, ETC., SHALL NOT BE ENLARGED OR "RUN OVER."
14. CONSTRUCTION SITES ARE REQUIRED TO HAVE EROSION CONTROL MATERIALS ON-SITE DURING THE "OFF-SEASON."
15. DUST CONTROL IS REQUIRED YEAR-ROUND.
16. EROSION CONTROL MATERIALS SHALL BE STORED ON-SITE.
17. USE OF PLASTIC SHEETING BETWEEN OCTOBER 1 AND APRIL 30 IS NOT ACCEPTABLE, UNLESS FOR USE ON STOCKPILES WHERE THE STOCKPILE IS ALSO PROTECTED WITH FIBER ROLLS CONTAINING THE BASE OF THE STOCKPILE.
18. TREE PROTECTION SHALL BE IN PLACE BEFORE ANY DEMOLITION, GRADING, EXCAVATING OR GRUBBING IS STARTED.

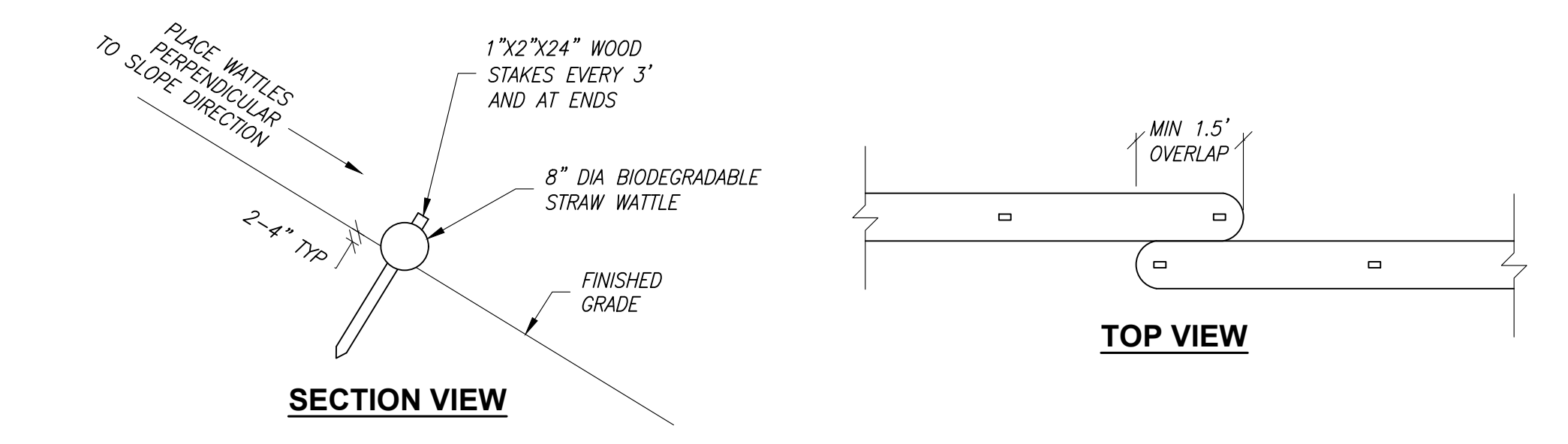

1 STRAW WATTLE DETAILS
NOT TO SCALE



REV. NO.	DESCRIPTION	DATE	APPROVED
1	REVISED SITE PLAN	7/09/2021	
2	ADDRESSED COMMENTS FROM COUNTY DPW 8-6-2020	8/13/2020	
3	REVISED DRAINAGE AND STORMWATER BMP'S	4/24/2020	
4	ADDRESSED COMMENTS FROM COUNTY 10/25/2019	11/5/2019	

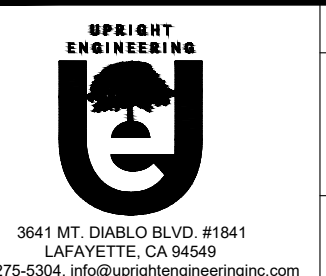

DATE: 7/9/2021		DESIGNED BY: MEL
NEW RESIDENCE APN# 037-147-030		DRAWN BY: MEL
SIERRA ST, MOSS BEACH, CA		SURVEYED BY: BGT
GRADING AND EROSION CONTROL PLAN		CHECKED BY: AP
		SHEET NO. 2 OF 5

PERMIT SET

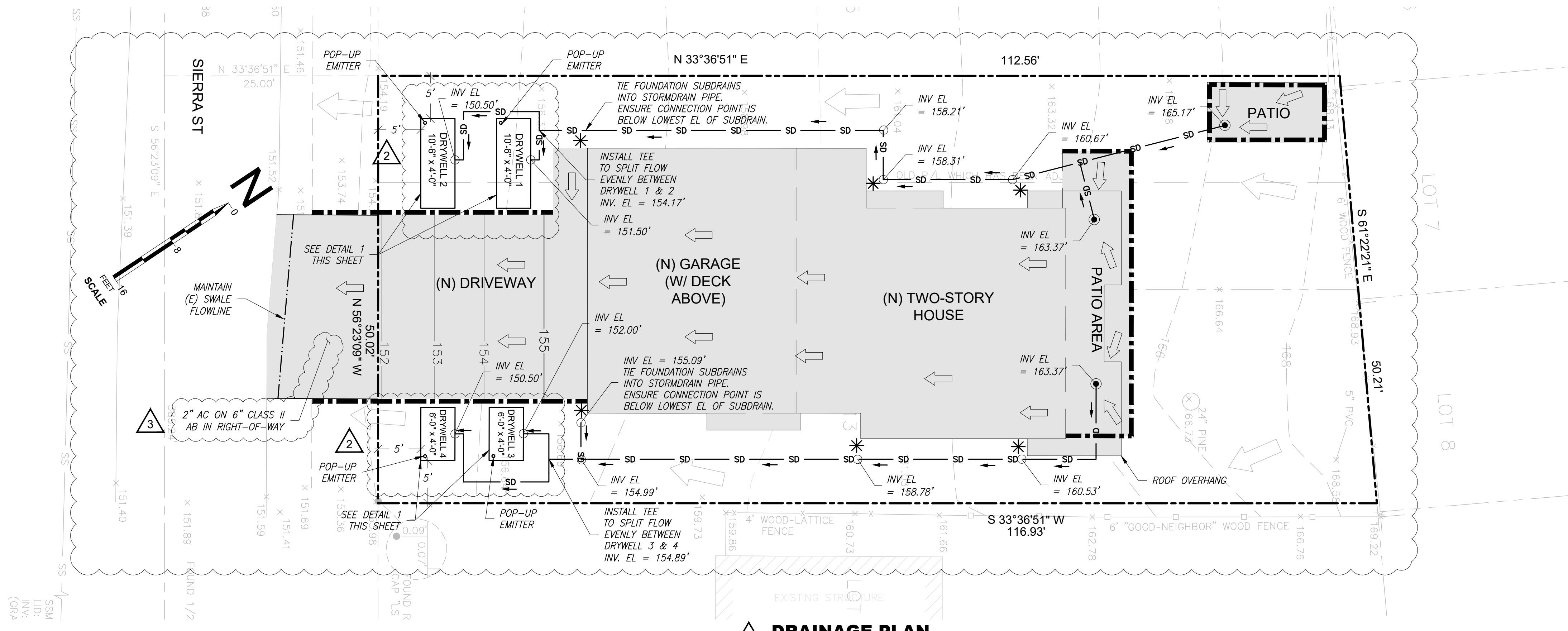

DMA #	ELEMENT	IMPERVIOUS AREA (SF)	PERVIOUS AREA (SF)
1	NATURAL GROUND	0	6012

DMA #	ELEMENT	IMPERVIOUS AREA (SF)	PERVIOUS AREA (SF)
1	NATURAL GROUND	0	3111
2	PROPOSED DRIVEWAY	829	0
4	PROPOSED RESIDENCE	2,072	0
NET NEW IMPERVIOUS AREA:		2,901 SF	
IMPERVIOUS AREA SERVED BY DRYWELLS:		2,072 SF	

4 DRAINAGE PLAN

LEGEND

- EXISTING MINOR CONTOUR
- EXISTING MAJOR CONTOUR
- EXISTING TOPO POINTS
- PROPOSED MINOR CONTOUR
- PROPOSED MAJOR CONTOUR
- △ * PROPOSED DOWNSPOUT TIE INTO STORM DRAIN PIPE PER DETAIL 4 SHEET 5
- PROPOSED AREA DRAIN, 4" SQUARE OR CIRCULAR PIPE GRATE BY NDS W/ TEE OR ELBOW BELOW, SEE DETAIL 3 ON SHEET 5
- ➔ PROPOSED IMPERVIOUS AREA (ARROW INDICATES DRAINAGE PATTERN)
- SD PROPOSED GRAVITY STORMDRAIN 4" SDR35 PVC PIPE MIN 2% SLOPE, MIN 18" BURIAL DEPTH CLEANOUTS SHALL BE PROVIDED AT ALL PIPE BENDS AND INTERSECTIONS
- ➔ EXISTING SITE DRAINAGE PATTERN
- PROPERTY LINE
- PROPOSED WALL (SEE GRADING PLAN)

GENERAL DRAINAGE NOTES:

1. ONSITE STORM DRAIN SYSTEM SHALL NOT CONNECT TO FRENCH DRAIN SYSTEM.
2. ALL JOINTS SHALL BE TIGHT GLUED AND ALL PIPES SHALL BE SOUND AND FREE FROM STRUCTURAL DEFECTS, CRACKS, BREAKS, OPENINGS, AND MISSING PORTIONS TO PREVENT EX-FILTRATION OR INFILTRATION BY GROUND WATER OR STORM WATER.
3. A MINIMUM 12" CLEARANCE SHALL BE MAINTAINED FROM ALL STORM DRAIN LINES AND OTHER UTILITIES.
4. THE OWNER SHALL BE RESPONSIBLE FOR REGULAR MAINTENANCE OF ALL DRAINAGE FACILITIES AND ASSOCIATED INFRASTRUCTURE.
5. PROPOSED DRIVEWAY AREA DOES NOT EFFECT DRYWELL CALCULATIONS.

OPERATIONS AND MAINTENANCE NOTES:

6. WATER LEVEL, DRAWDOWN TIME, AND EVIDENCE OF CLOGGING WILL BE MONITORED MONTHLY DURING THE RAINY SEASON.
7. STANDING WATER WILL NOT REMAIN ABOVE THE DRY WELL FOR MORE THAN 4 DAYS. EXTENDED PERIODS OF FLOODING MAY RESULT IN THE BREEDING OF MOSQUITOES OR OTHER VECTORS.
8. IF ROOF DOWNSPOUTS ARE CONNECTED TO THE DRY WELL, RAIN GUTTERS AND DOWNSPOUTS WILL BE INSPECTED AND CLEANED AT LEAST TWICE ANNUALLY.
9. IF THE DRY WELL EVER BECOMES PLUGGED AND OVERFLOWS ON A CONTINUAL BASIS, THE DRY WELL WILL BE REPAIRED OR REPLACED AS NECESSARY, AND GRAVEL MEDIA FILL WILL BE CLEANED OR REPLACED TO ENHANCE THE INFILTRATION CAPACITY.

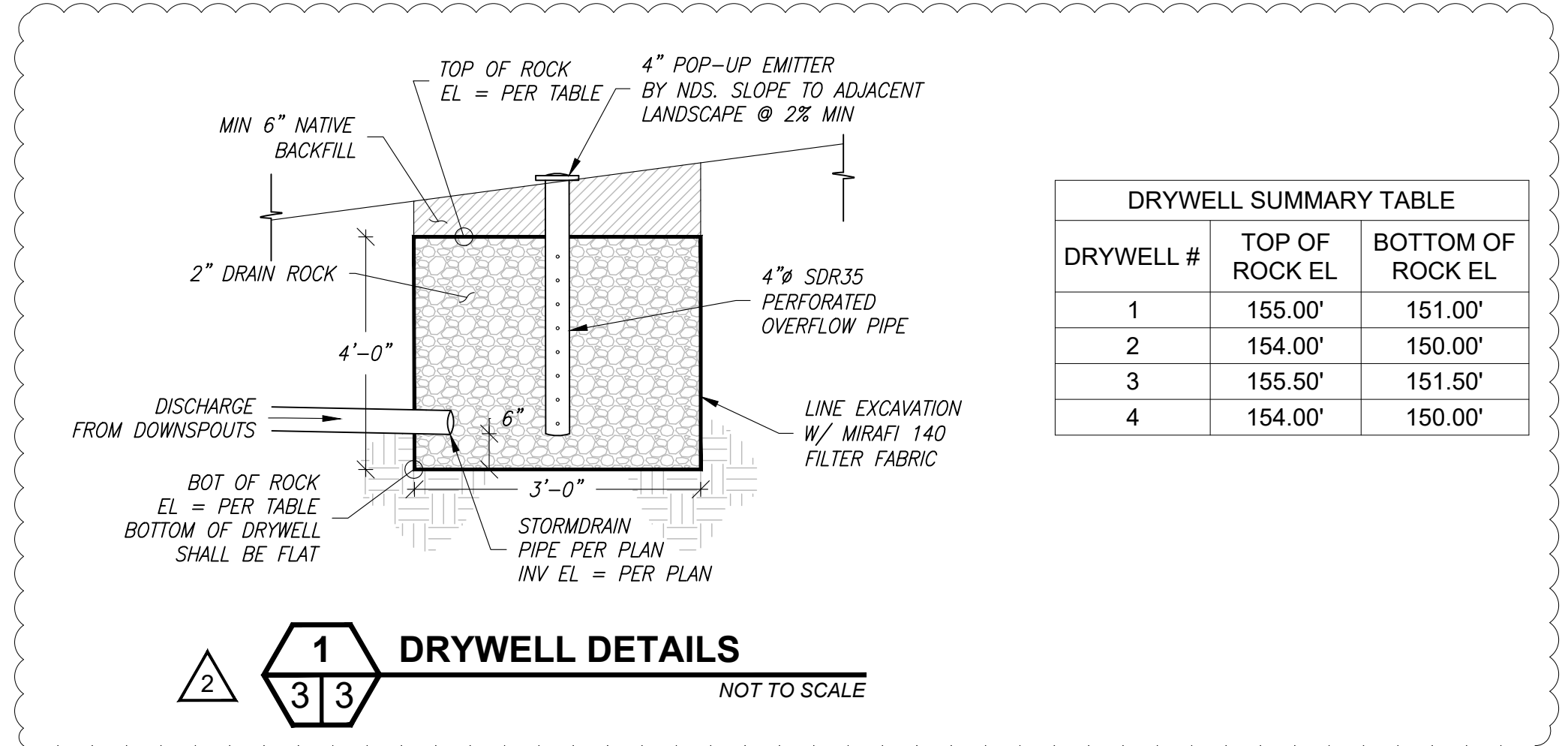

1 DRYWELL DETAILS

NOT TO SCALE



PERMIT SET

REV. NO.	DESCRIPTION	DATE	APPROVED
△ 1	REVISED SITE PLAN	7/09/2021	
△ 2	ADDRESSED COMMENTS FROM COUNTY DPW 8-6-2020	8/13/2020	
△ 3	REVISED DRAINAGE AND STORMWATER BMP'S	4/24/2020	



DATE: 7/9/2021	DESIGNED BY: MEL
NEW RESIDENCE	DRAWN BY: MEL
APN# 037-147-030	SURVEYED BY: BGT
SIERRA ST, MOSS BEACH, CA	CHECKED BY: AP
DRAINAGE PLAN	SHEET NO.
	3 OF 5

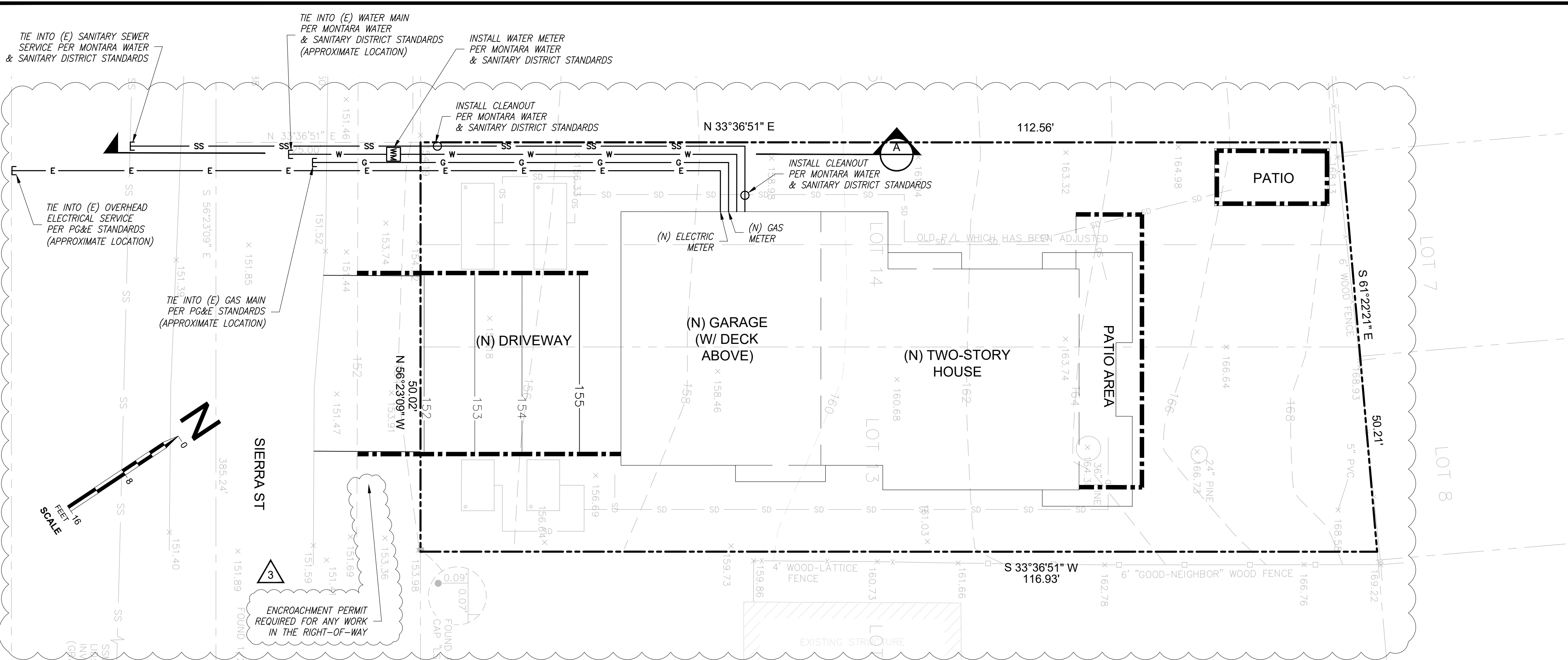

- LEGEND**
- - - - - EXISTING MINOR CONTOUR
 - - - - - EXISTING MAJOR CONTOUR
 - EXISTING TOPO POINTS
 - PROPERTY LINE
 - G----- PROPOSED UNDERGROUND NATURAL GAS LINE (PG&E)
 - E----- PROPOSED OVERHEAD ELECTRICAL LINE (PG&E)
 - W----- PROPOSED POTABLE WATER LINE (MONTARA WATER AND SANITARY DISTRICT)
 - SS----- PROPOSED 4" SANITARY SEWER LINE, 2% MIN. SLOPE (MONTARA WATER AND SANITARY DISTRICT)
 - SD----- PROPOSED STORM DRAIN SEE DRAINAGE PLAN
 - PROPOSED WALL (SEE GRADING PLAN)

MINIMUM UTILITY SEPARATION REQUIREMENTS

UTILITY	POTABLE WATER*	STORM WATER	SANITARY SEWER	GAS	ELECTRIC	COMM
POTABLE WATER	-	12"	12"	0"	12"	12"
STORM WATER	12"	-	12"	0"	24"	12"
SANITARY SEWER	12"	12"	-	0"	24"	12"
GAS	0"	0"	0"	-	24"	12"
ELECTRIC	12"	24"	24"	24"	-	12"
COMM	12"	12"	12"	12"	12"	-

* WHEN POTABLE WATER SHARES A JOINT TRENCH OR CROSSES SEWER AND/OR STORMWATER, POTABLE WATER SHALL ALWAYS BE ABOVE.

UTILITY PLAN

- GENERAL UTILITY NOTES:**
1. THE CONTRACTOR SHALL OBTAIN ALL NECESSARY OBSTRUCTION PERMITS FOR WORK IN THE PUBLIC RIGHT-OF-WAY.
 2. UTILITY LOCATIONS ARE APPROXIMATE AND SHALL BE FINALIZED BY THE CONTRACTOR IN THE FIELD.
 3. ALL UNDERGROUND AND ABOVEGROUND UTILITIES SHALL BE INSTALLED IN ACCORDANCE WITH ALL STATE, REGIONAL, AND LOCAL CODES AND REQUIREMENTS.
 4. MINIMUM BURIAL DEPTH SHALL BE 18" FOR ALL UTILITIES.
 5. ALL UTILITIES SHALL BE BURIED WITH DETECTABLE UNDERGROUND MARKING TAPE MEETING APWA STANDARDS. TAPE SHALL BE BURIED 12" ABOVE TOP OF UTILITY.
 6. PULL BOXES FOR ELECTRICAL AND COMMUNICATIONS UTILITIES SHALL BE SIZED AND SPACED PER CURRENT CALIFORNIA BUILDING CODE REQUIREMENTS.
 7. ELECTRICAL AND COMMUNICATION UTILITIES SHALL UTILIZE RACEWAYS WITH BENDS CONFORMING TO CURRENT CALIFORNIA BUILDING CODE REQUIREMENTS.
 8. UTILITIES SHALL MAINTAIN 3FT MIN CLEARANCE FROM ALL CONCRETE FOOTINGS, SLABS, AND BUILDING FOUNDATIONS.
 9. UTILITY TRENCH BACKFILL SHALL CONFORM TO THE REQUIREMENTS OF THE GEOTECHNICAL INVESTIGATION, THE UTILITY COMPANY, AND AS FOLLOWS:
 - 9.1. UTILITY TRENCH BACKFILL UNDER DRIVEWAYS SHALL BE CLASS II AB COMPACTED TO 95% RELATIVE COMPACTION AT NEAR OPTIMUM MOISTURE CONTENT. BACKFILL SHALL BE PLACED IN 6" LIFTS, WETTED, AND COMPACTED USING A VIBRATING PLATE OR JUMPING JACK. CARE SHOULD BE TAKEN NOT TO HARM UTILITIES DURING PRELIMINARY BACKFILL.
 - 9.2. UTILITY TRENCH BACKFILL NOT UNDER DRIVEWAYS SHALL BE NATIVE FILL FREE FROM ROCKS THAT COULD DAMAGE THE PIPE OR CONDUIT. IN THE EVENT THAT NATIVE FILL IS UNSUITABLE FOR TRENCH BACKFILL, CLASS II AB SHALL BE USED. BACKFILL SHALL BE PLACED IN 6" LIFTS, WETTED, AND COMPACTED USING A VIBRATING PLATE OR JUMPING JACK. CARE SHOULD BE TAKEN NOT TO HARM UTILITIES DURING PRELIMINARY BACKFILL.
 10. THE FOLLOWING APPLIES TO THE PROPOSED PRIVATE SEWER LATERALS (PSL):
 - 10.1. ALL SEWER LINES AND ASSOCIATED STRUCTURES, CLEANOUTS, BACKFLOW DEVICES, OVERFLOW PROTECTION DEVICES AND POINT OF CONNECTION TO THE SEWER MAIN SHALL COMPLY WITH MONTARA WATER AND SANITARY DISTRICT (MWSD) STANDARDS.
 - 10.2. THE PSL(S) TO THE PROPERTY SHALL BE TESTED. BEFORE FINAL BUILDING INSPECTION, ALL REPAIRS OR REPLACEMENTS NECESSARY TO BRING A PSL INTO COMPLIANCE SHALL BE PERFORMED. INSPECTION SHALL BE PERFORMED BY A CONTRACTOR LICENSED WITH THE STATE OF CALIFORNIA. IF THE LINE IS NOT COMPLIANT WITH CITY OF OAKLAND STANDARDS, A LICENSED CONTRACTOR SHALL PERFORM THE REQUIRED REPAIRS OR REPLACE THE LATERAL SUCH THAT IT MEETS THE REQUIREMENTS SET FORTH BY MWSD.
 - 10.3. PROPERTY OWNERS SHALL MAINTAIN ALL PSLs ASSOCIATED WITH THEIR PARCELS TO THE EXTENT NECESSARY TO ENSURE THE PSLs MEET THE STANDARDS AND REQUIREMENTS OF MWSD. PROPERTY OWNERS SHALL PERFORM ANY REPAIR OR REPLACEMENT NECESSARY TO ENSURE THE PSL MEETS THOSE STANDARDS AND REQUIREMENTS. THE PROPERTY OWNER IS ALSO RESPONSIBLE FOR THE CONNECTION OF THE PSL TO THE SEWER MAIN.
 - 10.4. THE PSL SHALL BE KEPT FREE FROM ROOTS, GREASE DEPOSITS, AND OTHER SOLIDS WHICH MAY IMPEDE OR OBSTRUCT THE FLOW.
 - 10.5. ALL JOINTS SHALL BE TIGHT AND ALL PIPES SHALL BE SOUNDS AND FREE FROM STRUCTURAL DEFECTS, CRACKS, BREAKS, OPENINGS, AND MISSING PORTIONS TO PREVENT EX-FILTRATION BY WASTE OR INFILTRATION BY GROUND WATER OR STORM WATER.
 - 10.6. THE GRADE OF EVERY PSL SHALL BE UNIFORM WITHOUT SAGS OR OFFSETS.
 - 10.7. THE PSL SHALL HAVE A TWO-WAY CLEANOUT LOCATED AT OR NEAR THE STRUCTURE. ALL CLEANOUTS SHALL BE SECURELY CAPPED AT ALL TIMES.
 - 10.8. THE PSL SHALL BE EQUIPPED WITH A BACKFLOW DEVICE/OVERFLOW DEVICE.
 - 10.9. THERE SHALL BE NO NON-SANITARY SEWER CONNECTIONS TO THE PSL PLUMBING THAT CONNECTS THERETO.
 - 10.10. THE PROPERTY OWNER SHALL PROVIDE CONNECTIONS TO THE SANITARY SEWER SYSTEM IN ACCORDANCE WITH ALL SECTIONS OF THE MWSD CODE.
 - 10.11. PROPERTY OWNERS SHALL REPORT WASTEWATER THAT IS RELEASED FROM A PSL TO THE SURFACE RESULTING IN A SANITARY SEWER OVERFLOW OR SPILL TO MWSD.

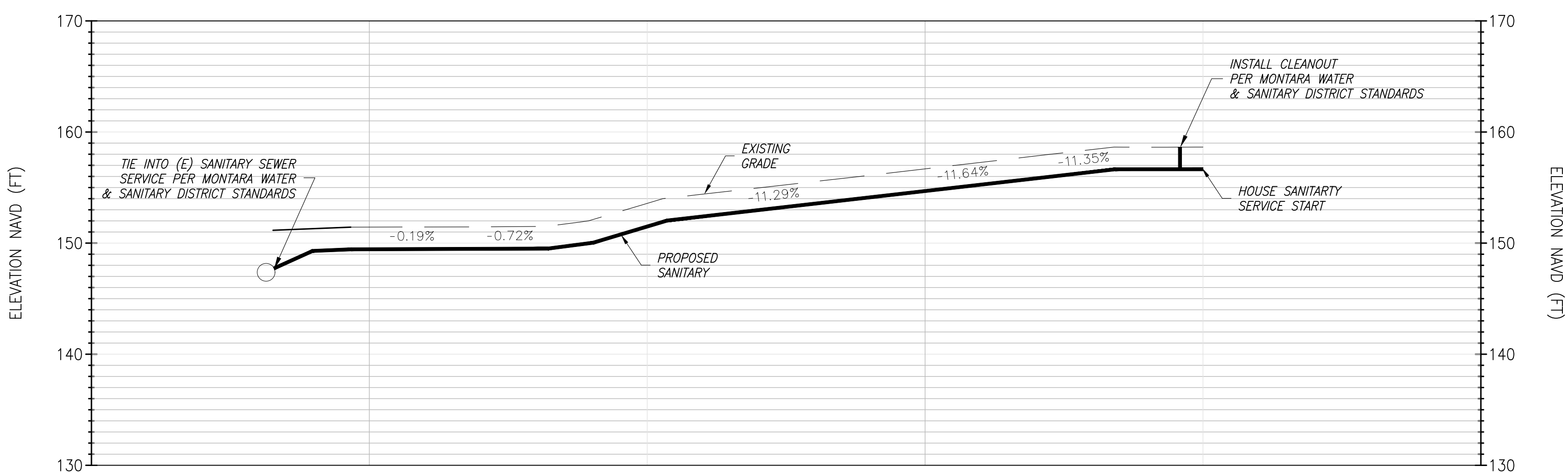

SANITARY SEWER SECTION
SCALE 1"=8'



PERMIT SET

REVISIONS

REV. NO.	DESCRIPTION	DATE	APPROVED
1	REVISED SITE PLAN	7/09/2021	
2	ADDRESSED COMMENTS FROM COUNTY DPW 8-6-2020	8/13/2020	

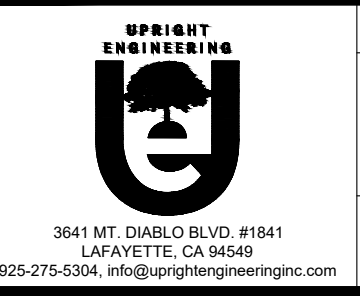

DATE: 7/9/2021
NEW RESIDENCE
 APN# 037-147-030
 SIERRA ST, MOSS BEACH, CA

DESIGNED BY: MEL
 DRAWN BY: MEL
 SURVEYED BY: BGT
 CHECKED BY: AP
 SHEET NO. **4 OF 5**

UTILITY PLAN

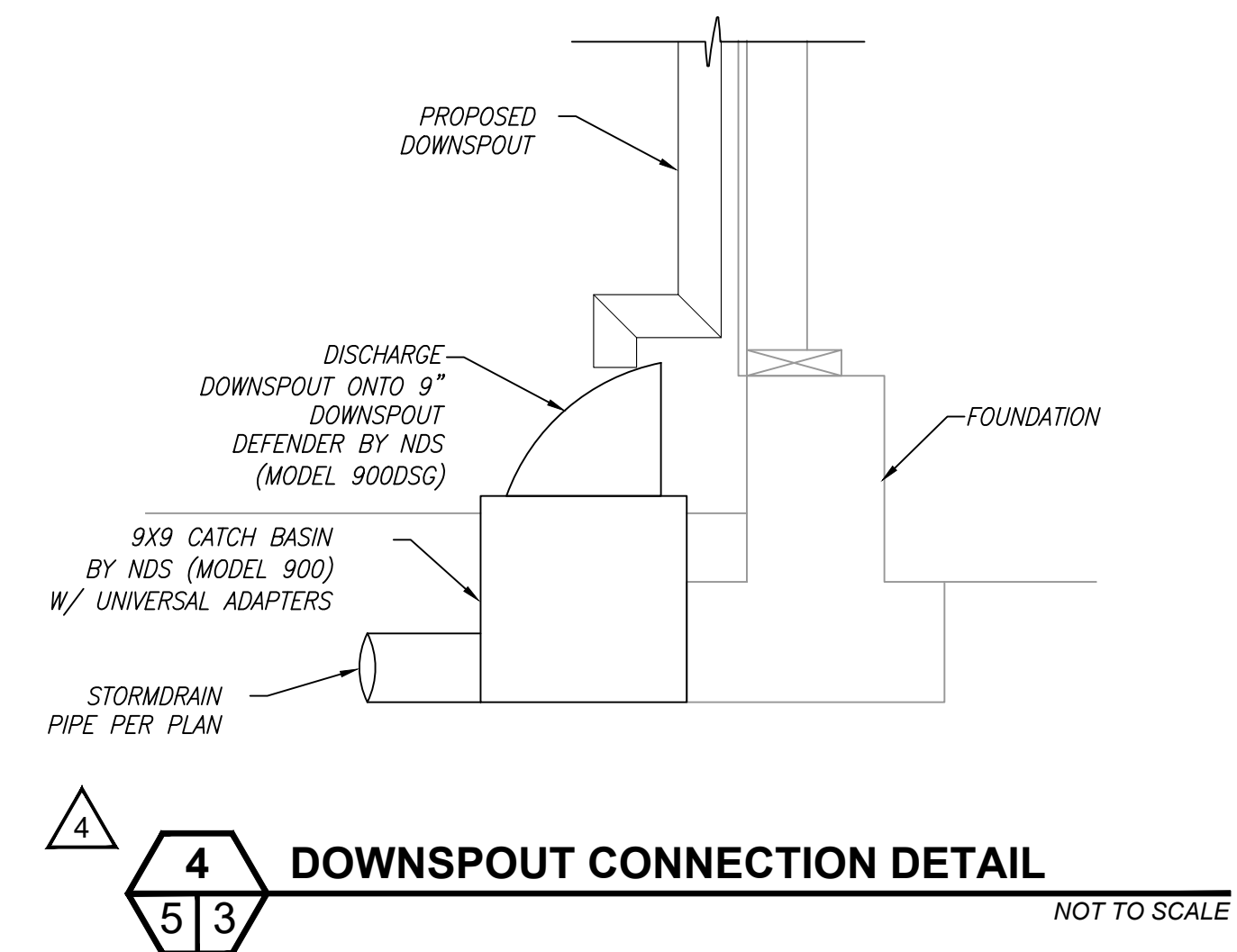
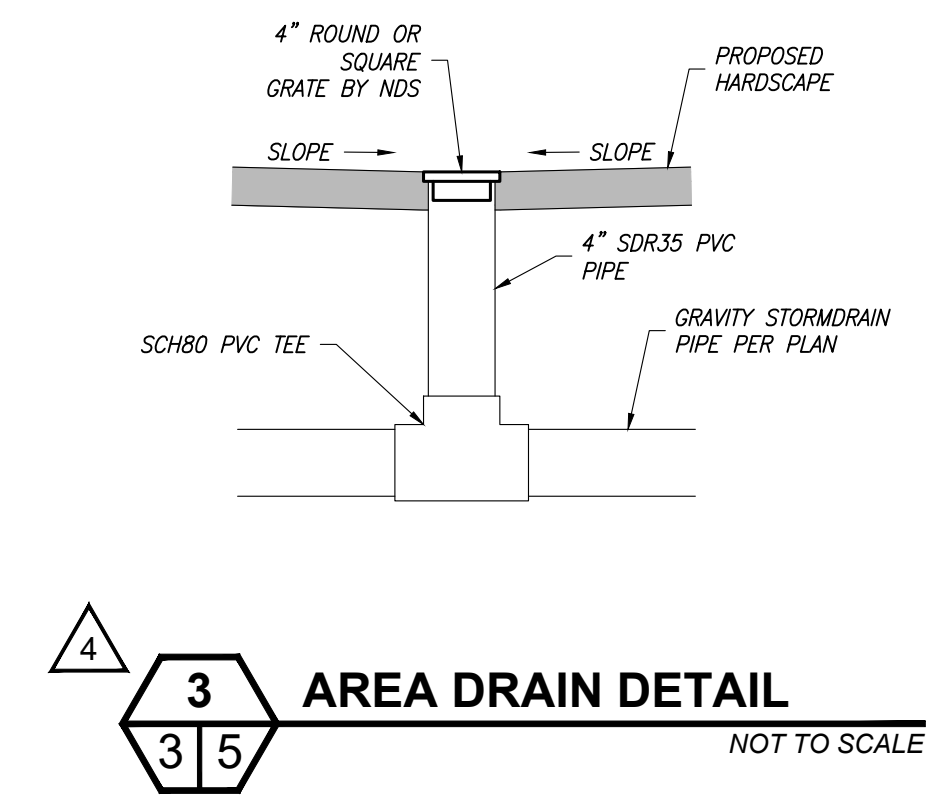
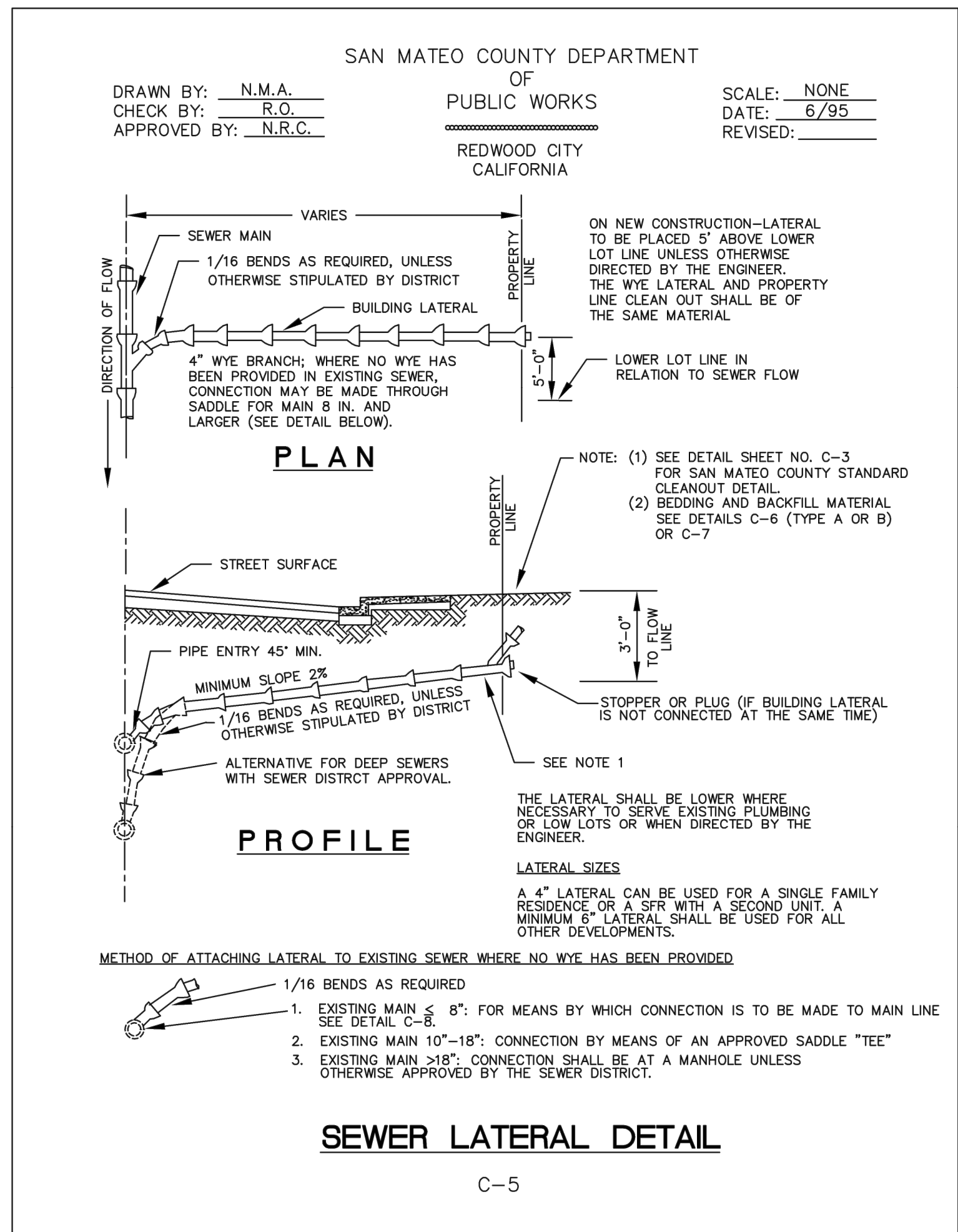
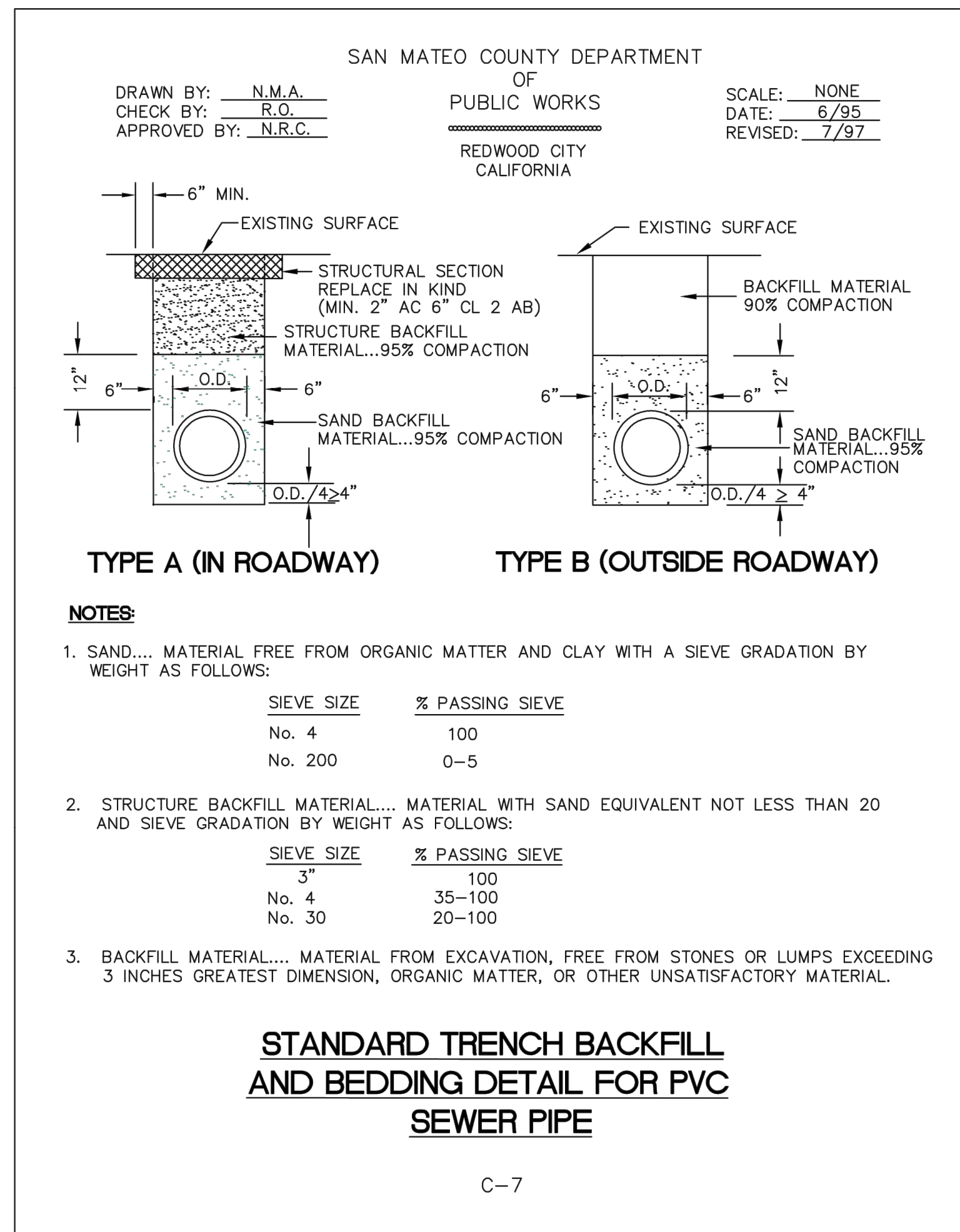

PERMIT SET

REV. NO.	DESCRIPTION	DATE	APPROVED
3	REVISED SITE PLAN	7/09/2021	
4	ADDRESSED COMMENTS FROM COUNTY DPW 8-6-2020	8/13/2020	



DATE: 7/9/2021
NEW RESIDENCE
 APN# 037-147-030
 SIERRA ST, MOSS BEACH, CA

DESIGNED BY: MEL
 DRAWN BY: MEL
 SURVEYED BY: BGT
 CHECKED BY: AP
 SHEET NO.

DETAILS

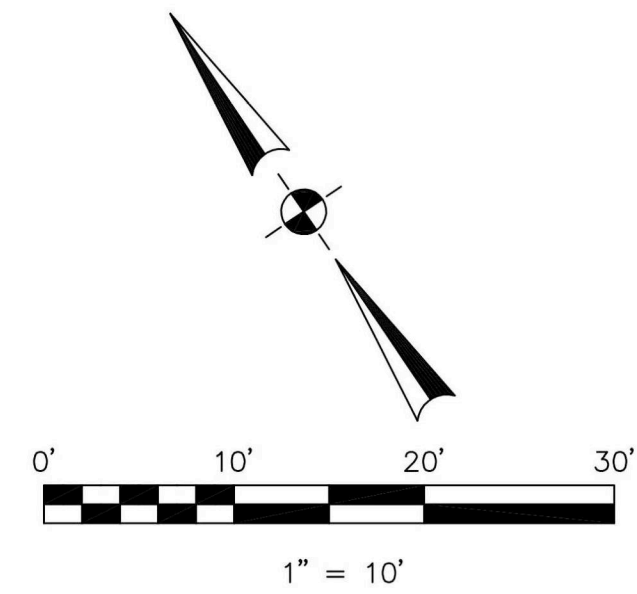

FOUND SAN MATEO COUNTY BRASS DISK WITH PUNCH IN HANDHOLE

BUENA VISTA ST.

BASIS OF BEARINGS

BEARINGS SHOWN HEREON TAKEN FROM THE RECORD OF SURVEY BY BGT WHICH WAS FILED FOR RECORD IN VOLUME 27 OF LLS MAPS PAGE 56 ON MAY 4, 2005, SAN MATEO COUNTY RECORDS.

BENCHMARK

ELEVATIONS SHOWN HEREON ARE BASED UPON AN ASSUMED DATUM. SITE BENCHMARK IS THE MAGSPIKE WITH STAINLESS STEEL WASHER WITH AN ASSUMED ELEVATION OF 151.75 FEET.

NOTES:

BGT DID NOT RECEIVE A TITLE REPORT COVERING THE SUBJECT PROPERTY. THEREFORE ANY EASEMENTS OF RECORD AFFECTING IT COULD NOT BE PLOTTED HEREON.

UTILITIES SHOWN HEREON TAKEN FROM VISUAL SURFACE EVIDENCE AND SHOULD BE CONSIDERED AS APPROXIMATE ONLY. ACTUAL LOCATIONS OF UTILITIES MAY VARY. TRUE LOCATION OF UTILITIES CAN ONLY BE OBTAINED BY EXPOSING THE UTILITY.

TREE LOCATIONS SHOWN HEREON ARE SHOWN SYMBOLICALLY WITH SYMBOL SIZES BASED UPON TRUNK DIAMETER AT CHEST HEIGHT, AT THE LOCATION WHERE THE TREE ENTERS THE GROUND SURFACE. LOCATIONS AND SIZES OF TREE TRUNKS CAN ONLY BE CONSIDERED APPROXIMATE UNLESS OTHERWISE STATED ON THE MAP. TREES OF TRUNK DIAMETER SIZES OF 6 INCHES OR GREATER WERE LOCATED BY THE FIELD CREW.

SURVEY PERFORMED BY: BGT LAND SURVEYING
www.bgtlandsurveying.com

DATE OF FIELD SURVEY: SEPTEMBER 28, 2017
JOB NUMBER: 17-127

LEGEND

- AC ASPHALT CONCRETE
- BW BACK OF WALK
- CB CATCH BASIN
- C/L CENTERLINE
- CMP CORRUGATED METAL PIPE
- CI CAST IRON PIPE
- CO CLEAN OUT BOX
- CP SURVEY CONTROL POINT
- CPP CORRUGATED PLASTIC PIPE
- CTV CABLE TELEVISION LINE
- DI DROP INLET
- EM ELECTRIC METER
- EV ELECTRIC VAULT
- FF FINISHED FLOOR
- FL FLOWLINE
- FH FIRE HYDRANT
- GM GAS METER
- GRD GROUND
- GUY GUY ANCHOR
- GV GAS VALVE
- HCR HANDICAP RAMP
- HVE HIGH-VOLT ELECTRIC
- INV INVERT
- IP IRON PIPE
- JP JOINT PILE
- KV KILOVOLT
- LAT. LATERAL
- LG LIP OF GUTTER
- MH MH (TYPE UNKNOWN)
- MON-MON MONUMENT TO MONUMENT DISTANCE
- PBV FACBELL/SBC VAULT
- PCE PACE VAULT
- PIV POST INDICATOR VALVE
- PP POWER POLE
- SDMH STORM DRAIN MANHOLE
- SL STREET LIGHT
- SLB STREET LIGHT BOX
- SLV STREET LIGHT VAULT
- SSMH SANITARY SEWER MANHOLE
- SSV SANITARY SEWER VAULT
- TBC TOP BACK OF CURB
- TBM TEMPORARY BENCHMARK
- TS TRAFFIC SIGNAL
- TSB TRAFFIC SIGNAL BOX
- UNK UNKNOWN TYPE
- VCP VITRIFIED CLAY PIPE
- WBF WATER BACK FLOW VALVE
- WM WATER METER BOX
- WV WATER VALVE
- CTV- CABLE TELEVISION LINE
- E- ELECTRICAL LINE
- G- GAS LINE
- OH- OVERHEAD LINE
- SD- STORM DRAIN LINE
- SS- SANITARY SEWER LINE
- T- TELEPHONE LINE
- W- WATER LINE

BASIS OF BEARINGS
N 28°42'00" E

CALIFORNIA AVE.
[40' WIDE]

248.85'

FOUND SAN MATEO COUNTY BRASS DISK WITH PUNCH IN HANDHOLE

SS

SS

SS

SITE BENCHMARK
MAGSPIKE WITH STAINLESS
STEEL WASHER WITH AN
ASSUMED ELEVATION OF 151.75 FEET.

SIERRA STREET
[50' WIDE]

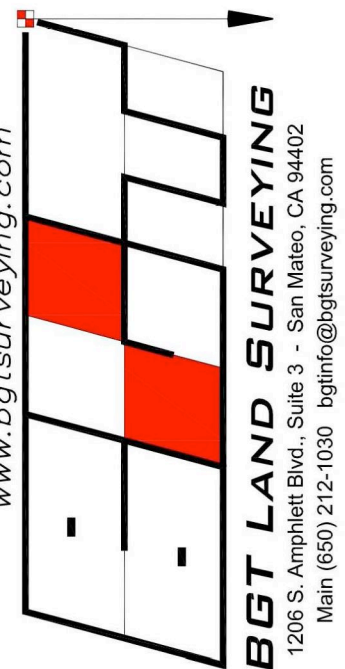
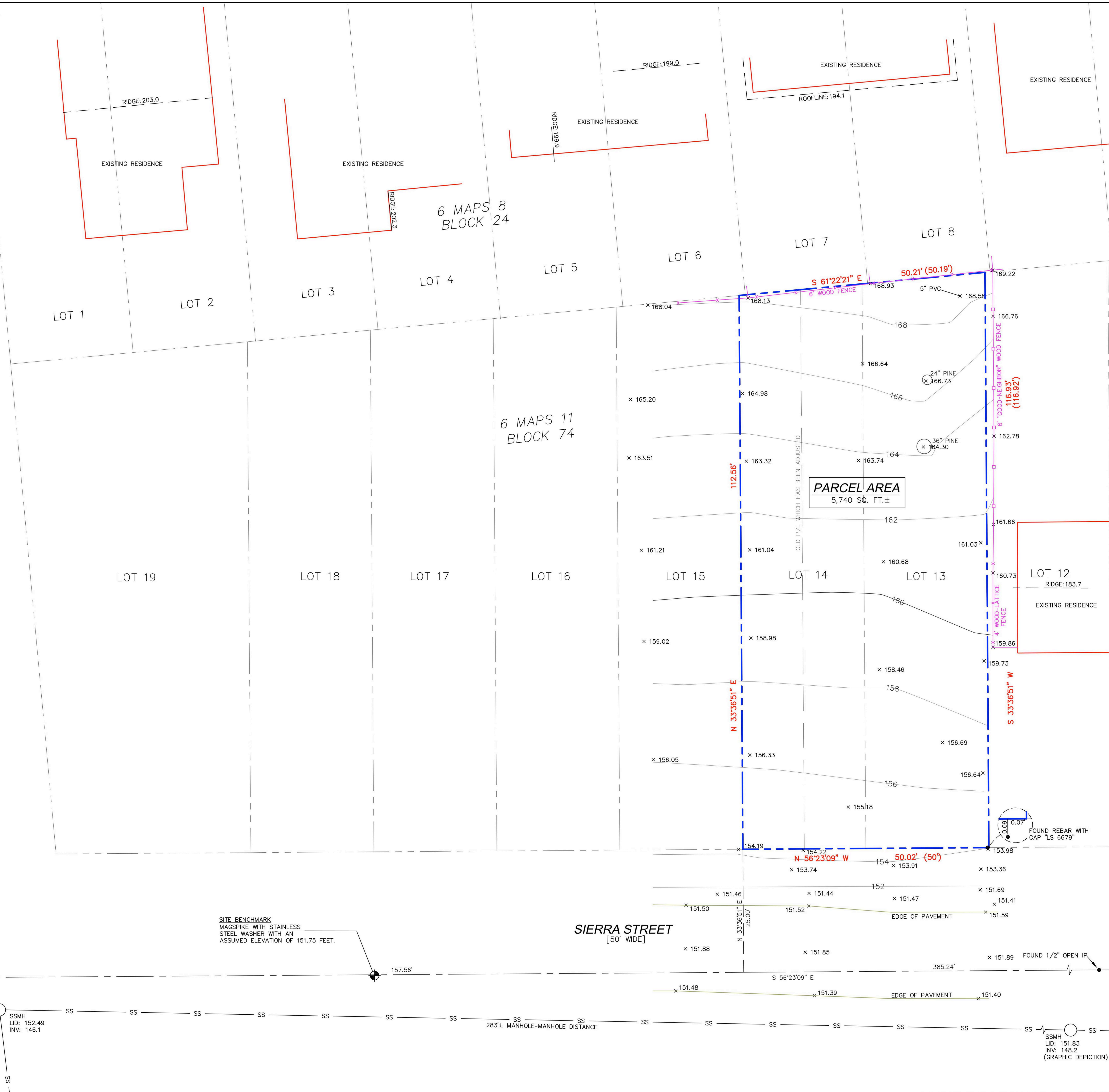

BOUNDARY AND TOPOGRAPHIC SURVEY
LOTS 13-14, BLOCK 74, MAP OF MOSS BEACH ADDITION NO. 1" (BOOK 6 MAPS 11)
VACANT PARCEL, SIERRA STREET
MOSS BEACH, COUNTY OF SAN MATEO, CALIFORNIA

Assessor Parcel Number:
037-147-030

Prepared For:
JUAN R. RODRIGUEZ
4243 Shelter Creek Lane
San Bruno, CA 94066

Date: JUNE, 2018
Scale: 1" = 10'

Contour Interval: 2'

Drawn by: BGT

Revisions:

SU-1

Job No. 17-127